

SPECIAL 20 24 WORLDWIDE



Das Werkzeug



 **Made in Germany**



Valid from 1 March 2024 until 28 February 2025.
Errors excepted.

TOOL TROLLEYS AND WORK BENCHES

Assistant **Made in Germany**

- ▶ Series 179N – suitable for every application: with a narrow width of 785 mm up to XXL format with a width of 1,133 mm and a depth of 642 mm
- ▶ Extremely robust design thanks to dual-wall structure
- ▶ Secure locking and heavy-duty drawer concept
- ▶ Sealed working surfaces protect trolley interior
- ▶ Developed and produced by HAZET "Made in Germany"



179N

- Plastic work surface

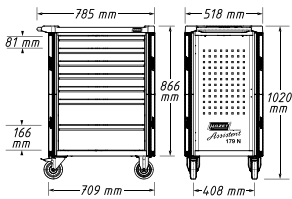

Made in Germany

HAZET No.	Number of drawers	EAN-No. 4000896+
179N-6	6	214570
179N-7	7	214488
179N-8	8	214587
179N-9	9	220236

3/3+

179NX

- Stainless steel work surface

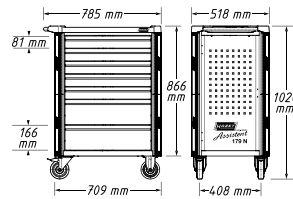

Stainless steel work surface
EDELSTAHL®
Rostfrei

Made in Germany

HAZET No.	Number of drawers	EAN-No. 4000896+
179NX-6	6	215560
179NX-7	7	215577
179NX-8	8	215584

3/3+

179NXL

- Stainless steel work surface

Wide design

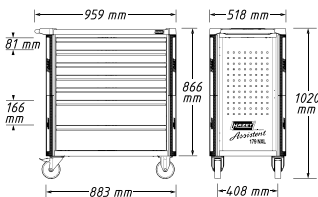

Stainless steel work surface
EDELSTAHL®
Rostfrei

Made in Germany

HAZET No.	Number of drawers	EAN-No. 4000896+
179NXL-6	6	215171
179NXL-7	7	215164
179NXL-8	8	215218

4/3+

179NXXL

- Stainless steel work surface

Extra wide design

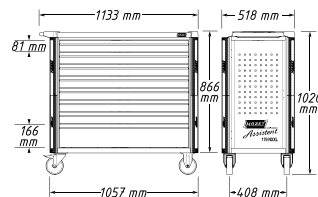

Stainless steel work surface
EDELSTAHL®
Rostfrei

Made in Germany

HAZET No.	Number of drawers	EAN-No. 4000896+
179NXXL-7	7	214624
179NXXL-8	8	214778

5/3+

179NXXL-8D/3

- Extra deep tool trolley



Over 30% more drawer depth

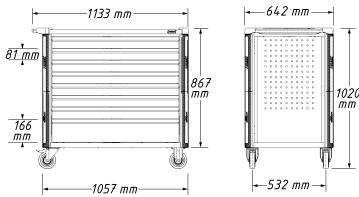

Extra wide, extra deep!

Stainless steel work surface
EDELSTAHL®
Rostfrei

179NXXL-8D/3 with lateral door and socket strip

Socket strip incl. 2 USB-A ports, 2 USB-C ports



Made in Germany

HAZET No.	Equipment	Number of drawers	EAN-No. 4000896 +
179NXXL-8D	Without lateral door and socket strip	8	242931
179NXXL-8D/3	With lateral door and socket strip	8	245178

Service trolley

- Adjustable in 15 height positions (middle tray)
- Loading capacity: 150 kg
- Loading capacity per tray: 50 kg

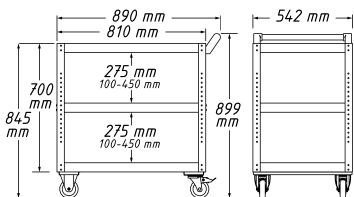

Made in Germany

167-3

EAN-No. 4000896205332



3/3+ 3/3+

179NW

- Mobile work bench

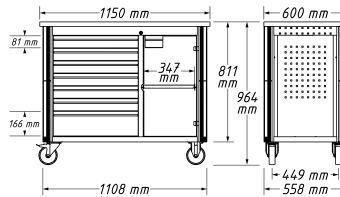

Cable duct on rear panel allows battery devices to be charged when the door is closed, for instance

Multiplex birch work surface, oiled, replaceable



Made in Germany

HAZET No.	Equipment	EAN-No. 4000896 +
179NW-7	6 flat drawers, 1 high heavy-duty drawer and one storage compartment	219629
179NW-8	8 flat drawers and one storage compartment	222933

Service trolley

- Square perforation on the side panels offers individual fastening options
- Adjustable in 15 height positions (middle tray)
- Loading capacity: 150 kg
- Loading capacity per tray: 50 kg

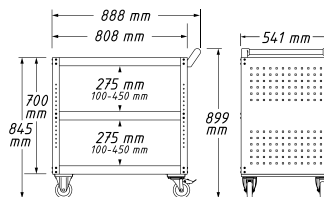

Made in Germany

167-3S

EAN-No. 4000896207206



3/3+ 3/3+

You have the choice between our tool trolley with stainless steel or plastic work surface or the stable work bench. Choose from our range: HAZET Basic or Comfort!

Basic assortment 228 expert tools

228

Including

HiPer

6.3 1/4" 10 3/8" 12.5 1/2"

163-513/122



Made in Germany

163-526/41



Basic assortment with tool trolley 179N-8 179N-8/228

EAN-No. 4000896250394



Made in Germany

163-525/40

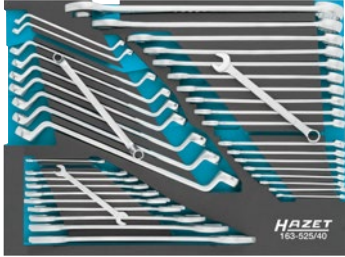

Comfort assortment 314 expert tools

314

Including

HiPer

6.3 1/4" 10 3/8" 12.5 1/2"

163-513/122



Made in Germany

Comfort assortment with tool trolley 179N-8 179N-8/314

EAN-No. 4000896250417



Made in Germany

163-526/41



163-525/40



Comfort assortment with tool trolley 179NX-8 179NX-8/314

EAN-No. 4000896250455

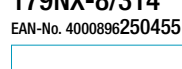

Stainless steel work surface
EDELSTAHL®
Rostfrei

Including 2128N-1



Basic assortment with tool trolley 179NX-8 179NX-8/228

EAN-No. 4000896250431

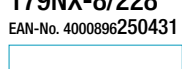

Stainless steel work surface
EDELSTAHL®
Rostfrei



Made in Germany

Basic assortment with work bench 179NW-7 179NW-7/228

EAN-No. 4000896250479

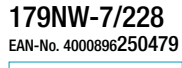

163-609/61



Made in Germany

Comfort assortment with work bench 179NW-7 179NW-7/314

EAN-No. 4000896250493

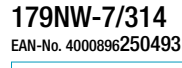

163-372/25



Including 2128N-1



178N-7/147 with 147 expert tools

- Plastic work surface

147

3/3		
-----	--	--

Including
HiPer
6.3 1/4 12.5 1/2



178N-7/147
EAN-No. 4000896205080



163-466/106

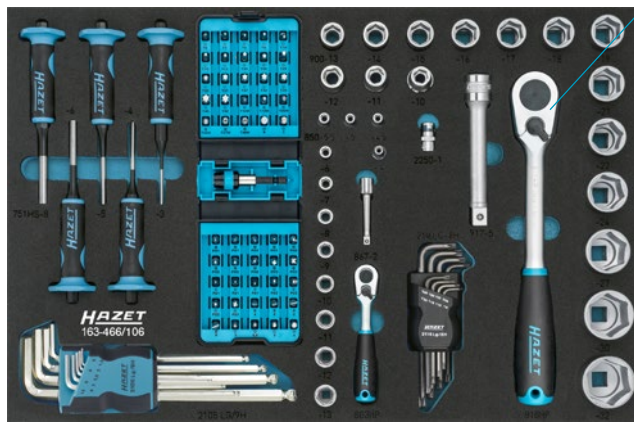

163-98/17 s 6 – 24 mm



163-95/8 s 6 x 7 – 21 x 22 mm

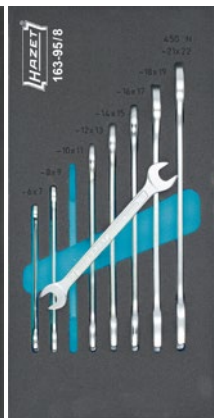

163-330/16



Plastic work surface, resistant to solvent, with integrated storage wells
Work surface border strip prevents parts from falling down



179NXL-8/321 with 321 expert tools

Stainless steel work surface
EDELSTAHL
Rostfrei

321



4/3+

Including
HiPer
 6.3 1/4 10 3/8 12.5 1/2



179NXL-8
 Made in Germany
 Wide design: 959 mm
 518 mm

163-549/160



179NXL-8/321
 EAN-No. 4000896224395

163-478/40



163-480/57



163-479/26



163-522x50

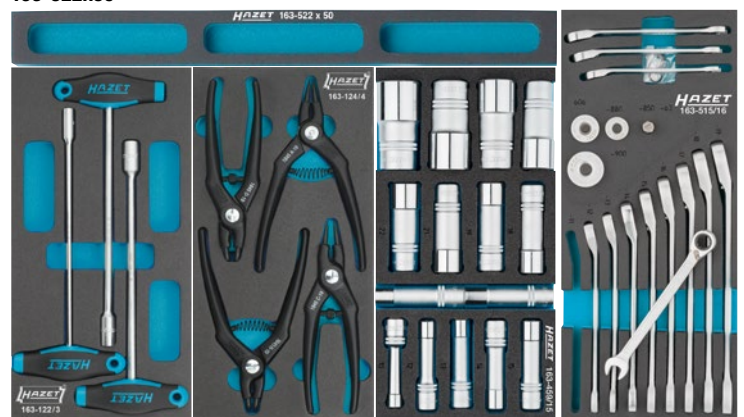

163-122/3 163-124/4 163-459/15 12.5 1/2 163-515/16

179NXL-8/440 with 440 expert tools

Made exclusively for you by our professional specialists!



Stainless steel work surface
EDELSTAHL®
Rost frei

440

Perfect tool set for the passenger car / van workshop!



179NXL-8
Made in Germany
Wide design: 959 mm

518 mm

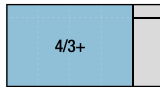

179NXL-8/440
EAN-No. 4000896247974

Including

HiPer
6.3 1/4 10 3/8 12 1/2

Assortment



163-606/259

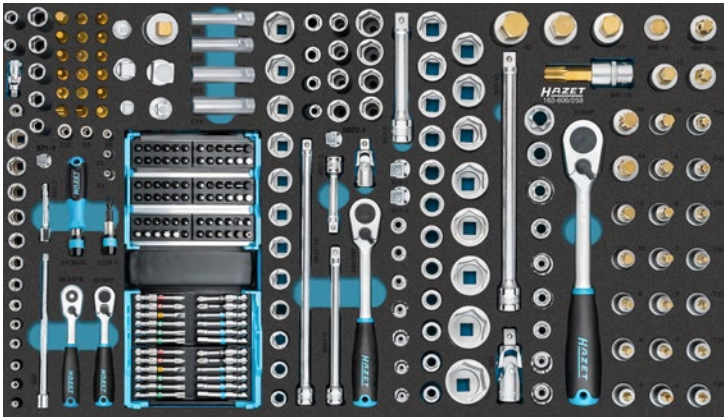

163-528/56 s 6x7 - 34x36 mm, s 6 - 32 mm,
s 8 - 19 mm, s 6x7 - 24x27 mm



163-604/34



163-603/52

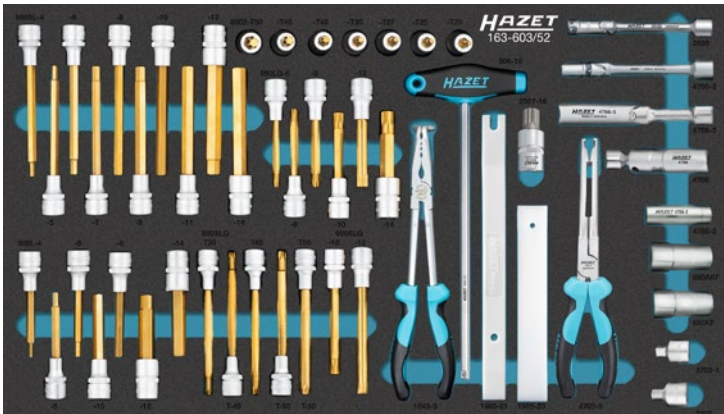

163-605/39



179NXXL-7/340 with 340 expert tools

Stainless steel work surface

340



5/3+

Including
HiPer
6.3 1/4 10 3/8 12.5 1/2



Including
2128N-1



179NXXL-7/340

EAN-No. 4000896215072



163-481/194



163-511/4



163-480/57



163-510/8



163-478/40

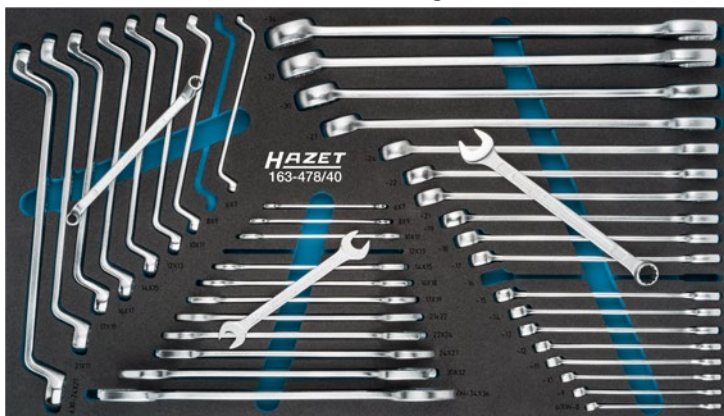

163-509/12



179NXXL-8/378 with 378 expert tools

5/3+

Including
HiPer
6.3 1/4 10 9/8 12 1/2



Including
2128N-1



163-481/194



163-172x50

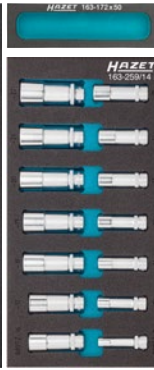

163-478/40

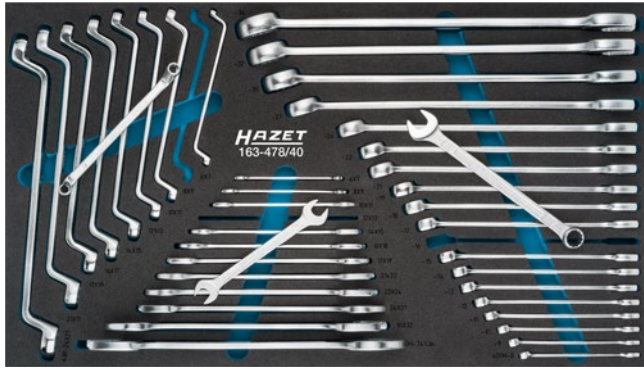

163-515/16

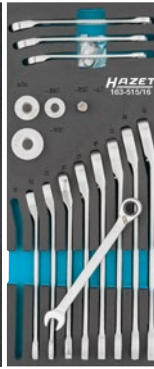

163-527/56



163-380/4

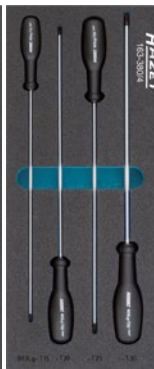

163-479/26



163-382/3

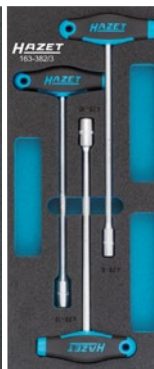

Tool trolley / work bench accessories



More information on
accessories at:
www.hazet.de



HAZET No.	Designation
179N-33	Paper bin incl. holder
161N-3D/2	Cable drum incl. holder
161N-3D	Cable drum (without holder)
179N-45	Tablet holder
179N-35	Can holder, for at least 4 cans
179N-46	Impact wrench holder
179NW-11	Machinist's vice fastening set
179N-42	Laptop holder for 179N · 179NX · 179NXL · 179NXXL
179-35	Can holder, for 3 cans
180-24	Document holder
179N-21	Lateral door for 179N · 179NX · 179NXL · 179NXXL
180-34	Holder for paper reel
179N-40	Basic fixture for 179N · 179NX · 179NXL · 179NXXL · 179NXXL-8D
179N-26	Perforated tool panel for 179N · 179NX
179N-75	Machinist's vice fastening for 179N · 179NX · 179NXL · 179NXXL
179NXL-26	Perforated tool panel for 179 NXL
179NXXL-26	Perforated tool panel for 179NXXL
179N-21D	Lateral door for 179NXXL-8D
161N-5D	Socket strip for 179NXXL-8D
179N-50	Bracket for an L-Boxx
179N-51	Bracket set for two L-Boxxes
179N-510	Bracing surface for L-Boxx bracket 179N-51
179ND-75	Machinist's vice fastening for 179NXXL-8D · 179NXXL-8D/3
179N-75	Machinist's vice fastening for 179N · 179NX · 179NXL · 179NXXL
2175N	Machinist's vice

179NXL-8-VW/243 with 243 expert tools

Stainless steel work surface
EDELSTAHL Rostfrei

243



4/3+

Including
HiPer
 6.3 1/4 12.5 1/2



179NXL-8-VW/243
 EAN-No. 4000896220250

Specialized tool assortment for
VOLKSWAGEN • AUDI



179NXL-8-VW
 Made in Germany
 Wide design: 959 mm
 Colour: RAL 7012

518 mm

163-369/104 20 3/4 6.3 1/4 12.5 1/2



163-374/27

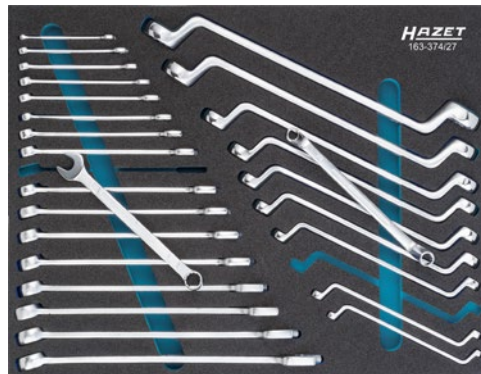

163-367/31

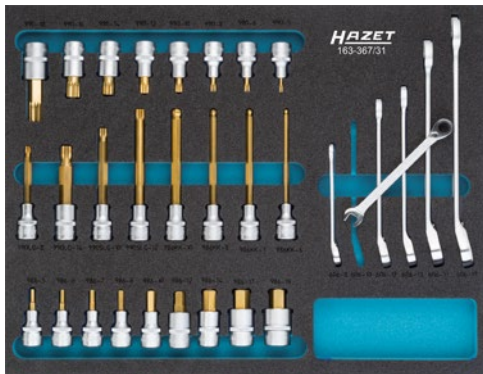

163-373/39



163-370/9

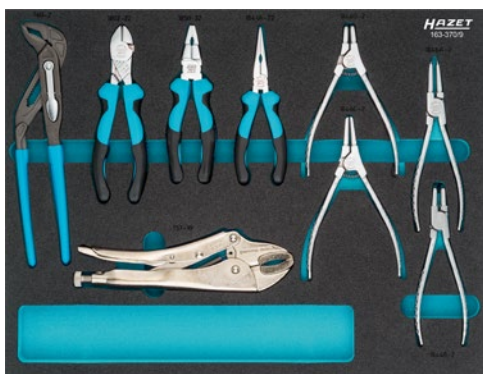

163-371/17 12.5 1/2 3/8



163-372/25



179NT-8-RAL7016/2 with 264 expert tools

- Plastic work surface

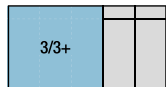

Including
HiPer
6.3 1/4 12⁵ 1/2



179NT-8-RAL7016/2

EAN-No. 4000896220281

Specialized tool assortment for
BMW



With lateral door!

163-105/90-BMW



163-104/77-BMW



163-106/33-BMW

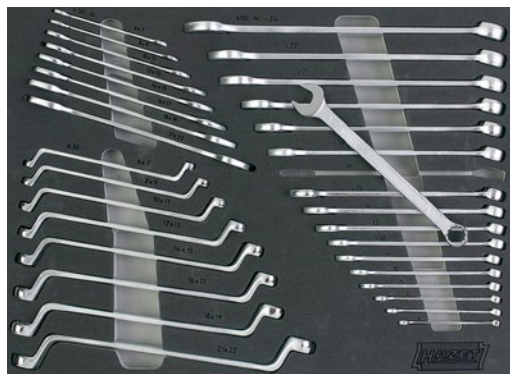

163-109/18-BMW



163-108/9-BMW



163-107/31-BMW



Combination wrenches
600 N
s27 · 30 · 32 mm



Pick-up tool with claws 1975
Length: 540 mm

Magnetic pick-up tool 1976-2
Length: 475 mm

Extension 918-23
Length: 575 mm



TOOL BAGS FOR CRAFTS AND TRADES

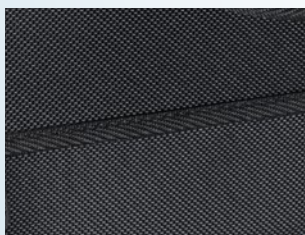

Ultimate tool bag for professionals: robust outer shell made of high-strength polyester, developed for tough construction site conditions



Comfortable transport: Special carrying strap with wide, padded shoulder strap minimises the carrying weight and prevents uncomfortable pressure



Organised system: Individual compartments for each tool allow quick access and easy insertion

Tool bag, large, with 89 expert tools



470 x 310 x 300 mm
(Length x height x width)

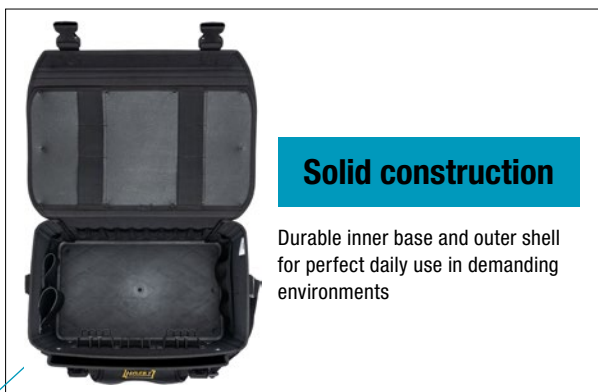

Solid construction

Durable inner base and outer shell for perfect daily use in demanding environments

89 **NEW!**

191T-2/89
EAN-No. 4000896259984



HAZET No.	Designation	
2140-50	BluGuard engineer's hammer	1
1850VDE-33	Combination pliers · with protective insulation	1
1803VDE-22	Diagonal cutter · with protective insulation	1
1841aVDE-22	Snipe nose pliers · with protective insulation	1
1860VDE-11	Wire stripper · with protective insulation	1
839-1	Phase tester	1
810VDE-25	Screwdriver for electricians · with protective insulation \ominus 0.4 x 2.5 mm	1
810VDE-30	Screwdriver for electricians · with protective insulation \ominus 0.5 x 3 mm	1
810VDE-35	Screwdriver for electricians · with protective insulation \ominus 0.6 x 3.5 mm	1
810VDE-40	Screwdriver for electricians · with protective insulation \ominus 0.8 x 4 mm	1
810VDE-PH1	Screwdriver for electricians · with protective insulation \oplus PH1	1
810VDE-PH2	Screwdriver for electricians · with protective insulation \oplus PH2	1
810VDE-PH3	Screwdriver for electricians · with protective insulation \oplus PH3	1
810VDE-T20	Screwdriver for electricians · with protective insulation \odot T20	1
810VDE-T25	Screwdriver for electricians · with protective insulation \odot T25	1
810VDE-T30	Screwdriver for electricians · with protective insulation \odot T30	1
2200SC-2	SmartCase socket set	50

HAZET No.	Designation	
1981	Small hack saw	1
2154-40	Spirit level 40 cm	1
2154-200	Folding ruler	1
824-6	Painter's spatula	1
762-26	Grip pliers wrench NEW!	1
2105LG/9H	Offset screwdriver set	9
4617-1	Control cabinet key	1
731-2	Flat chisel	1
730-7	Flat chisel	1
2156VDE-2	Cable stripping knife · with protective insulation	1
197-73/5	Plaster cup set	5
191T-2L	Tool bag large, empty	1

HAZET No.	Designation	EAN-No. 4000896 +
191T-2L	Tool bag large, empty NEW!	258505



Practical additional space:
Additional compartment in the front of the bag for secure storage of plans and papers



Improved working:
Ideal bag for crafts and trades professionals to maximise efficiency and organisation on the construction site



Ease of use:
Quick and handy storage of the most frequently used tools indoors

Tool bag, small, with 51 expert tools

51 **NEW!**



191T-1/51
EAN-No. 4000896260003

430 x 285 x 190 mm
(Length x height x width)



HAZET No.	Designation	■
1981	Small hack saw	1
2157-1	Jack-knife	1
811/6	Screwdriver set	6
839-1	Phase tester	1
2304SH-2	SmartHolder with 16 screwdriver bits - short	16
2304SH-12	SmartHolder with 8 screwdriver bits - long	8
2100/6H	Offset screwdriver set	6

HAZET No.	Designation	■
811BH	Insert tool holder for bits	1
1859SPC/3	Pliers set	3
2140-40	BluGuard engineer's hammer	1
2154-200	Folding ruler	1
824-6	Painter's spatula	1
197-73/5	Plaster cup set	5
191T-1L	Tool bag small, empty	1

HAZET No.	Designation	EAN-No. 4000896 +
191T-1L	Tool bag small, empty	258482

Tool set in L-Boxx

83

Incl. SmartCase 2200SC-1



L-BOXX

190L-136/83
EAN-No. 4000896243303



Roofing hammer

• Hammer head weight: 600 g



Made in Germany
2138-600
EAN-No. 4000896246311

Beam puller



Made in Germany
1774-1
EAN-No. 4000896180578

• Span: 115 mm
• Overall width: 440 mm
• Ratchet length: 275 mm

DEVELOPED AND PRODUCED BY HAZET

Made in Germany

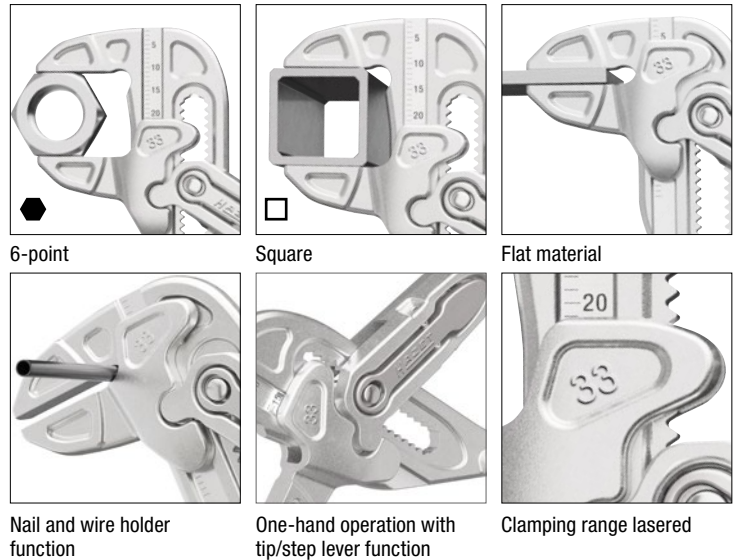

Grip pliers wrenches

- Compact and at the same time highly resilient
- In four different lengths: 125 · 150 · 180 · 260 mm
- Convenient – thanks to quick adjustment with proven HAZET tip/step lever function
- One-hand presetting possible
- Permanent laser-marked scaling for easy setting and reading
- High corrosion resistance due to chrome-plated, easy-to-clean pliers legs
- Heavy-duty pliers legs made of case-hardened chrome vanadium steel
- Pleasant to grip thanks to double dip coating – lies well in the hand
- Fine detent distance enables any wrench size in the clamping range

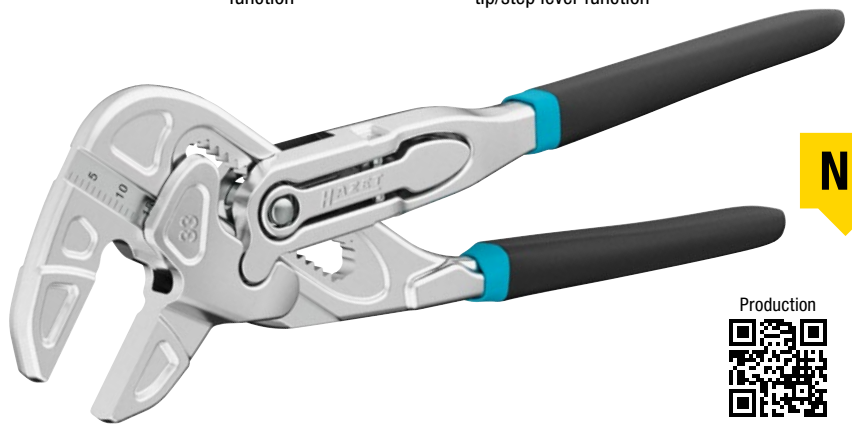

NEW!

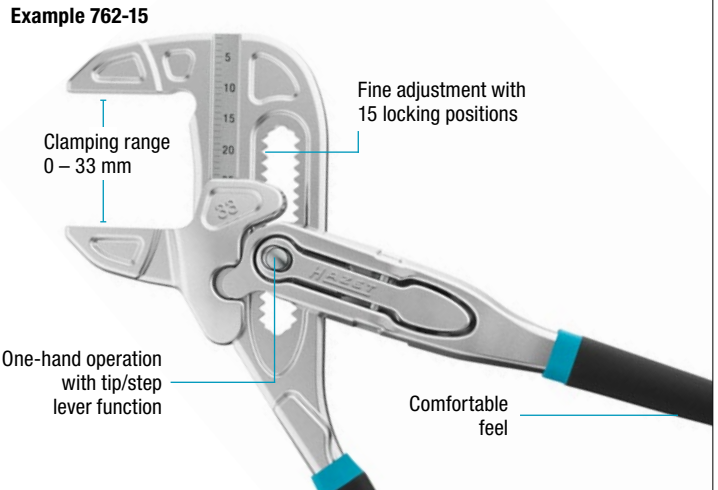
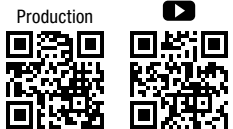

Made in Germany

HAZET No.	Length mm	Detent distance mm	Number of detent positions	Clamping range mm	EAN-No. 4000896 +
762-12	125	2	12	26	249800
762-15	150	2	15	33	249640
762-18	180	2	19	42	249787
762-26	260	2.5	20	56	249664

Protective jaws

- Contents: 3 pairs



Made in Germany

762-018/6	Protective jaws for grip pliers wrench 762-18	259861
762-026/6	Protective jaws for grip pliers wrench 762-26	259885

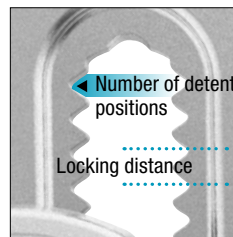

DEVELOPED AND PRODUCED BY HAZET

Made in Germany

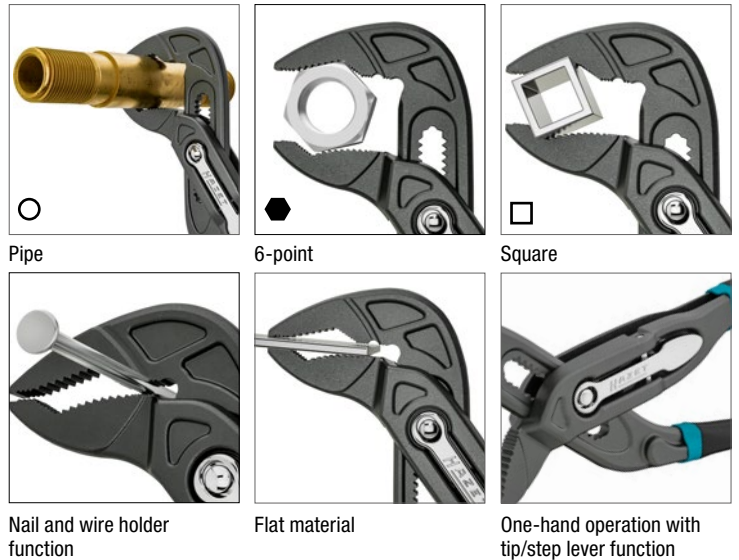

Universal pliers

- Compact and at the same time highly resilient
- In four different lengths: 125 · 150 · 180 · 260 mm
- Convenient – thanks to quick adjustment with proven HAZET tip/step lever function
- Long service life due to extremely hard jaw serration with additional inductive hardening
- More force thanks to teeth offset against the direction of rotation
- Precise detent with the aid of laser-cut serration
- Heavy-duty pliers legs made of case-hardened chrome vanadium steel
- Phosphatized surface
- Pleasant to grip thanks to double dip coating – lies well in the hand
- Fine detent distance enables any wrench size in the clamping range



NEW!

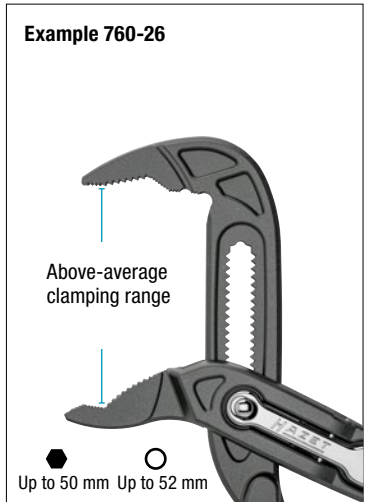

Made in Germany

HAZET No.	Length mm	Detent distance mm	Number of detent positions	Clamping range mm	EAN-No. 4000896 +
760-12	125	2	13	● 27 ○ 32	249749
760-15	150	2	14	● 34 ○ 38	249688
760-18	180	2	17	● 36 ○ 42	249763
760-26	260	2.5	17	● 50 ○ 52	249701

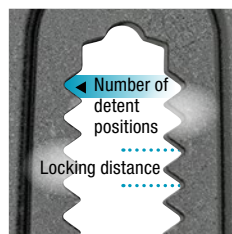

* Valid from 1 March 2024 until 28 February 2025. Errors excepted.

HAZET COLOURCODE

Guarantees that the profile can be found quickly thanks to the distinctive HAZET colour coding on each screwdriver bit



1/4" SmartHolder

6.3 1/4
6.3 1/4
6.3 1/4
6.3 1/4

1/4" SmartHolder with 39 tools

- 18 screwdriver bits short, 25 mm:
 - s 0.6 x 4.5 mm
 - PH1 · PH2 · PH3, PZ1 · PZ2 · PZ3
 - s 3 · 4 · 5 · 6 · 8 mm
 - T10 · T15 · T20 · T25 · T30 · T40
- 6 screwdriver bits long, 50 mm:
 - PZ1 · PZ2
 - s 4 · 5 mm
 - T20 · T25
- 6 sockets, hexagon:
 - s 5.5 · 7 · 8 · 10 · 12 · 13 mm
- Mini solid steel fine-tooth reversible ratchet
- Bit holder with magnet
- Adapter 6.3 = 1/4" → 6.3 = 1/4"



39

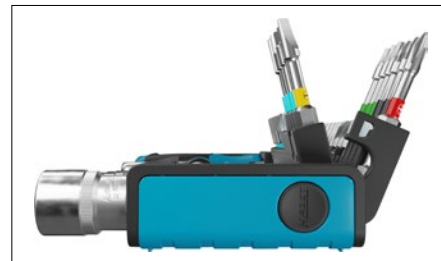

2300SH-1
EAN-No. 4000896246588



reddot winner 2023

6.3 1/4

Incl. mini solid steel fine-tooth reversible ratchet 863MB



1/4" SmartHolder with 16 screwdriver bits, short 25 mm

6.3 1/4

- s 0.5 x 4 · 1.2 x 6.5 mm
- PH1 · PH2 · PH3
- s 3 · 4 · 5 · 6 mm
- T10 · T15 · T20 · T25 · T27 · T30 · T40



2304SH-1
EAN-No. 4000896250677

16

6.3 1/4

- s 0.4 x 1.5 · 0.5 x 4 · 1.2 x 6.5 mm
- PZ1 · PZ2 · PZ3
- s 3 · 4 · 5 · 6 mm
- T10 · T15 · T20 · T25 · T30 · T40



2304SH-2
EAN-No. 4000896250653

16

6.3 1/4

- T6 · T7 · T8 · T9 · T10 · T15 · T20 · T25 · T27 · T30 · T40
- T10H · T15H · T20H · T25H · T30H



2304SH-3
EAN-No. 4000896250639

16

1/4" SmartHolder with 8 screwdriver bits, long 50 mm

6.3 1/4

- PH1 · PH2
- s 3 · 4 · 5 mm
- T15 · T20 · T25



2304SH-11
EAN-No. 4000896250615

8

6.3 1/4

- 0.8 x 5.5 mm
- PZ1 · PZ2
- s 4 · 5 · 6 mm
- T20 · T25



2304SH-12
EAN-No. 4000896250592

8

6.3 1/4

- T10 · T15 · T25 · T27 · T30 · T40
- T20 (2x)



2304SH-13
EAN-No. 4000896250578

8

1/4" SmartCase

6.3 1/4"
 6.3 1/4"
 6.3 1/4"

69

1/4" screwdriver bit and offset screwdriver set



Assortment



2200SC-1

EAN-No. 4000896239252



6.3 1/4"
 6.3 1/4"
 6.3 1/4"
 6.3 1/4"

73

1/4" screwdriver bit and offset screwdriver set, TORX® inside hexagon



Assortment



2200SC-31

EAN-No. 4000896244539

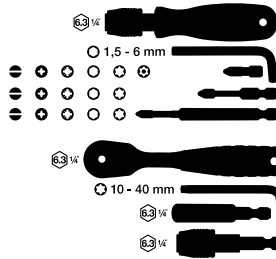

6.3 1/4"
 6.3 1/4"
 6.3 1/4"
 6.3 1/4"

50

1/4" socket and screwdriver bit set



Assortment



2200SC-2

EAN-No. 4000896239603

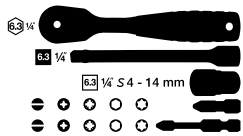

6.3 1/4"
 6.3 1/4"
 6.3 1/4"
 6.3 1/4"

59

1/4" socket and screwdriver bit set



Assortment



2200SC-32

EAN-No. 4000896244546

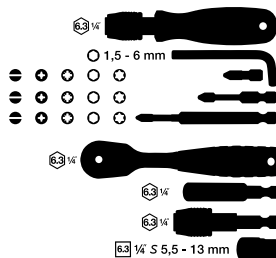

6.3 1/4"
 6.3 1/4"

96

1/4" screwdriver bit set



Assortment



2200SC-3

EAN-No. 4000896244522





SMARTRAIL – DURABLE, ROBUST TWIST LOCK FOR A TIGHT FIT AND INSTANT ACCESS!

- ▶ Magnetic underside ensures perfect hold on all magnetic surfaces, e.g. tool trolleys, tool panels, machines, lifting platforms and in drawers
- ▶ Flexible plastic connector strip with 1/4" or 1/2" square slots
- ▶ Easy to clean material and pleasant surface feel
- ▶ Securely fixed when locked: turn socket left to remove
- ▶ Incl. robust metal lug for hanging, e.g. on a hook

1/4" SmartRail

1/4" slots (7x), empty

- Dimensions: 245 x 37.4 x 29.2 mm



Made in Germany

850SR-7

EAN-No. 4000896249626

1/2" SmartRail

1/2" slots (5x), empty

- Dimensions: 245 x 37.4 x 29.2 mm



Made in Germany

900SR-5

EAN-No. 4000896244508

1/2" SmartRail

1/2" slots (8x), empty

- Dimensions: 365 x 37.4 x 29.2 mm



Made in Germany

900SR-8

EAN-No. 4000896244515

1/4" hexagon, long
50 mm

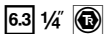

- s 5.5 · 6 · 7 · 8 · 10 · 12 · 13 mm



Made in Germany

850LG-SR/7

EAN-No. 4000896250691

1/2" impact socket

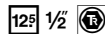

- Plastic sleeve to protect the rim
- s 17 mm (3x) · 19 mm (2x)



Made in Germany

903SLG-SR/5

EAN-No. 4000896245253

1/2" serration,
short

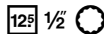

- s M5 · M6 · M8 · M10 · M12 · M14 · M16 · M18

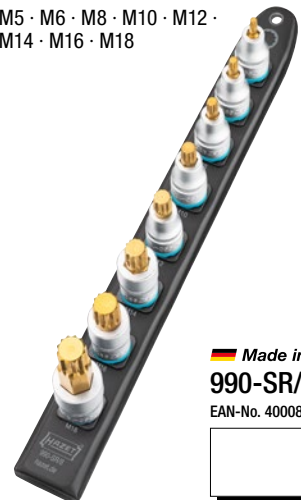

Made in Germany

990-SR/8

EAN-No. 4000896245352



Further SmartRail combinations at www.hazet.de/smartrail

1/4" Mini bit cordless screwdriver set

- Max. loosening torque: 4.5 Nm
- Vibration acceleration: 180 m/s²
- Revolutions per minute: 180

Contents:

- 4 screwdriver bits, long, 50 mm:
 - PZ1 · PZ 2
 - s 4 mm
 - T20
- Charging cable: 1.5 m
- Matching holster



HAZET
ION

9230B-1
EAN-No. 4000896250820

1/4" double bit holder with T-handle

- Total length: 97 mm
- Blade length: 7.5 mm and 63 mm



Made in Germany
866BH-4
EAN-No. 4000896249329

1/4" telescopic bit holder with T-handle

- Total length: 241 – 394 mm
- Blade length: 205 – 358 mm



Made in Germany
866BH-14
EAN-No. 4000896249336

1/4" spin type speeder with T-handle

6.3 1/4"

Short design

- Length: 134 mm
- Blade length: 100 mm



866-4
EAN-No. 4000896242979

6.3 1/4"

Long design

- Length: 300 mm
- Blade length: 266 mm



866-10
EAN-No. 4000896241842

1/4" screwdriver bit set



							36



HAZET colour code system and size information on the handle:
the different drives are categorised according to colour coding. These colours complement the size information on the handle and make it easier to find the required screwdriver quickly

- HAZET colour code system and size information on the handle:
-
-
-

NEW!

NEW SCREWDRIVER FAMILY IN A STANDARDISED DESIGN

The 803 and 810 screwdriver series has given rise to a new product family: the series 811. It combines all the innovative and practical features of the two previous series.

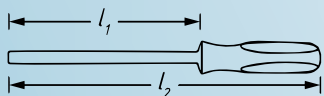

Slot



HAZET No.		Blade mm	l_1 mm	l_2 mm	EAN-No. 4000896+
811-20		0.4x2	60	145	258529
811-25		0.4x2.5	75	160	258543
811-30		0.5x3	80	165	258567
811-35		0.5x3.5	100	185	258581
811-40		0.8x4	100	185	258604
811-55		1.0x5.5	125	230	258628
811-65		1.2x6.5	150	265	258642
811-80		1.2x8	150	265	258666
811-100		1.6x10	175	290	258680
811LG-55		1.0x5.5	300	415	258703

TORX®



HAZET No.		Blade mm	l_1 mm	l_2 mm	EAN-No. 4000896+
811-T6		T6	60	145	258840
811-T7		T7	60	145	258864
811-T8		T8	60	145	258888
811-T9		T9	60	145	258901
811-T10		T10	80	165	258925
811-T15		T15	80	165	258949
811-T20		T20	100	185	258963
811-T25		T25	100	205	258987
811-T27		T27	115	220	259007
811-T30		T30	115	230	259021

Phillips



HAZET No.		Blade mm	l_1 mm	l_2 mm	EAN-No. 4000896+
811-PH0		PH0	60	145	258727
811-PH1		PH1	80	185	258741
811-PH2		PH2	100	215	258765
811-PH3		PH3	150	265	258789

TORX® extra long



HAZET No.		Blade mm	l_1 mm	l_2 mm	EAN-No. 4000896+
811LG-T15		T15	250	335	259045
811LG-T20		T20	250	335	259069
811LG-T25		T25	250	355	259083
811LG-T30		T30	250	365	259106

Pozidriv



HAZET No.		Blade mm	l_1 mm	l_2 mm	EAN-No. 4000896+
811-PZ1		PZ1	80	185	258802
811-PZ2		PZ2	100	215	258826

Nut-driver, flexible



HAZET No.		Blade mm	l_1 mm	l_2 mm	EAN-No. 4000896+
811F-6		6	150	255	259342
811F-7		7	150	255	259366
811F-8		8	150	255	259380



Special design prevents unwanted rolling away

Impact cap in the handle: The 811S screwdrivers have a robust metal impact cap for tougher applications. It ensures force-fit transmission of hammer blows to the tip of the screwdriver

Laser marking on the blade: The length and type of output as well as the article number are laser-marked on the blade, which enables the correct tool to be clearly and permanently identified

A neat and tidy workshop: A hanging hole in the handle makes it easy to attach the screwdriver to a hook on the tool panel

NEW!



TWO-COLOURED HANDLE = THREE PLASTICS

Three different plastics that are easy to handle and comfortable to work with.

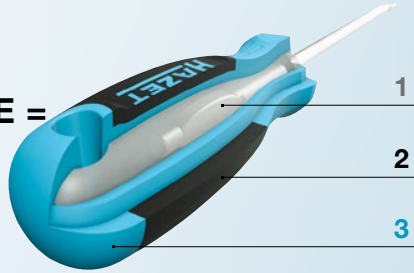

Optimum power and grip

Hard core holds the blade extra-firmly in position so that the maximum torque can be achieved when screwing

Soft component ensures very good grip even under difficult working conditions and with lubricating surfaces (oils, greases)

Hard component (very robust) gives the perfect shape, stability and a premium feel with every screwing operation



Screwdriver, short

HAZET No.		Blade mm	l ₁ mm	l ₂ mm	EAN-No. 4000896 +
811K-35	☉	0.6x3.5	25	85	259427
811K-55	☉	1.0x5.5	25	85	259441
811K-80	☉	1.2x8.0	25	85	259465
811K-PH1	⊕	PH1	25	85	259489
811K-PH2	⊕	PH2	25	85	259502

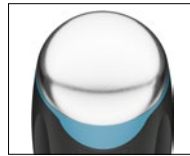

Integrated steel cap



Blade with hex bolster



With impact cap

HAZET No.		Blade mm	l ₁ mm	l ₂ mm	EAN-No. 4000896 +
811S-45	☉	0.8x4.5	75	175	259120
811S-55	☉	1.0x5.5	100	200	259144
811S-70	☉	1.2x7	125	235	259168
811S-PH1	⊕	PH1 80	80	180	259182
811S-PH2	⊕	PH2 100	100	210	259205
811S-PH3	⊕	PH3 150	150	260	259229



Electronic screwdriver

HAZET No.		Blade mm	l ₁ mm	l ₂ mm	EAN-No. 4000896 +
811EL-015	☉	0.23x1.5	60	153	259526
811EL-02	☉	0.4x2.0	60	153	259540
811EL-025	☉	0.4x2.5	75	168	259564
811EL-03	☉	0.5x3.0	75	168	259588
811EL-PH00	⊕	PH00	60	153	259601
811EL-PH0	⊕	PH0	60	153	259625
811EL-PH1	⊕	PH1	60	153	259649
811EL-T5	⊕	T5	60	153	259663
811EL-T6	⊕	T6	60	153	259687
811EL-T7	⊕	T7	60	153	259700
811EL-T8	⊕	T8	60	153	259724
811EL-T9	⊕	T9	60	153	259748
811EL-T10	⊕	T10	60	153	259762
811EL-T15	⊕	T15	80	173	259786



1/4" spin type speeder

HAZET No.		Blade mm	Handle size	Total length	EAN-No. 4000896 +
811-UK	⊕ 1/4"	L40	70	110	259328



* Valid from 1 March 2024 until 28 February 2025. Errors excepted.

Slot / Phillips set



811/6
EAN-No. 4000896258383



4 x		0.5x3.0 · 0.8x4.0 · 1.0x5.5 · 1.2x6.5 mm
2 x		PH 1 · PH 2

TORX® set



811T/6
EAN-No. 4000896258406



6 x		T10 · T15 · T20 · T25 · T27 · T30
-----	--	-----------------------------------

Set with impact cap



811S/5
EAN-No. 4000896258420



3 x		0.8x4.5 · 1.0x5.5 · 1.2x7 mm
2 x		PH 1 · PH 2



Electronic screwdriver,
TORX® set



811EL-T/7
EAN-No. 4000896259922



7 x		T5 · T6 · T7 · T8 · T9 · T10 · T15
-----	--	------------------------------------

Electronic
screwdriver set



811EL/7
EAN-No. 4000896259908



4 x		0.23x1.5 · 0.4x2 · 0.4x2.5 · 0.5x3 mm
3 x		PH00 · PH1 · PH2

1/4" bit holder



811BML
EAN-No. 4000896259243
 l_2 mm
205



811BM
EAN-No. 4000896259946
 l_2 mm
115



EJECT
811BH
EAN-No. 4000896259267
 l_2 mm
136

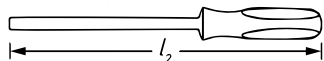

Small
811BMK
EAN-No. 4000896259281
 l_2 mm
80



Short
811KBM
EAN-No. 4000896259403
 l_2 mm
70

EJECT

- Screwdriver bits can be accommodated without operating the sleeve – screwdriver bit can also be inserted in locked state
- The screwdriver bit is removed simply pushing it forward – quick bit change with only one hand
- Strong permanent magnet to hold the screwdriver bits securely in place



EJECT, small
811BHK
EAN-No. 4000896259304
 l_2 mm
101

Combination wrench set

- Up to 70% above DIN
- Slim heads
- Box-end head angled at 15°
- Surface: chrome-plated, head polished



10

Made in Germany

600SPC/10

EAN-No. 4000896118465

s 8 · 10 · 12 · 13 · 14 · 15 · 16 · 17 · 18 · 19 mm



Ratcheting combination wrench set

- Ratchet function with one-hand reversing switch
- Fine-tooth, 72 teeth · Operating angle 5° · 13° angled
- Surface: chrome-plated

5



606/5

EAN-No. 4000896177998

s 8 · 10 · 13 · 17 · 19 mm

1/4", 3/8", 1/2", 3/4" adapter set

- With locking ball

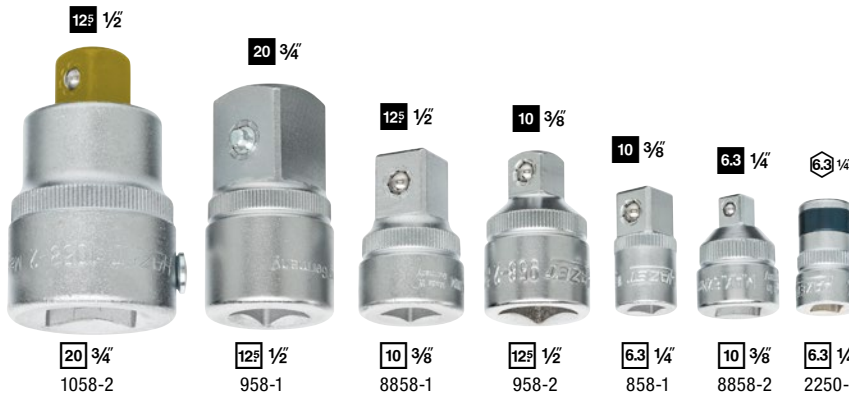

Made in Germany

958/7

EAN-No. 4000896204595

20 3/4
1058-2

12.5 1/2
958-1

10 3/8
8858-1

12.5 1/2
958-2

10 3/8
858-1

6.3 1/4
8858-2

6.3 1/4
2250-1



Quick-clamping puller set

- In display stand



5-piece set:

	sb mm	st mm
1750-9	100	80
1750-11	135	80
1750-14	135	135
1750-19	185	160
1750-26	260	220

1750/5

EAN-No. 4000896251476

Quick-clamping puller



1750-34

EAN-No. 4000896250042

sb mm	st mm	Spindle mm
345	260	M 27 x 2 x 377

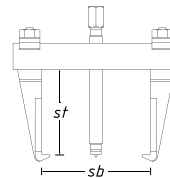

- Solid all-steel bridge
- Forged arms



1750-44

EAN-No. 4000896250134

sb mm	st mm	Spindle mm
440	260	M 27 x 2 x 377

HIGH-VOLTAGE TOOLS WITH PROTECTIVE INSULATION

- ▶ For safe and hazard-free working
- ▶ For use up to 1000 volts
- ▶ Test report according to IEC 60900
- ▶ Special HAZET 1000 V protective insulation: two-tone multilayer safety insulation, a red layer on the outside and a yellow layer on the inside

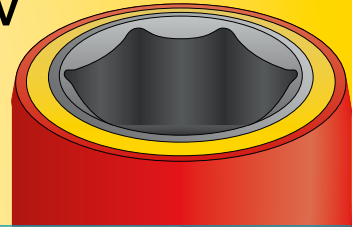
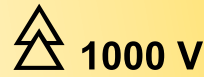

3/8" HiPer fine-tooth reversible ratchet – with protective insulation

10 3/8"

- 90 teeth, small operating angle of only 4°
- Sockets are securely locked in place
- Attached tools can easily be released by pressing the button
- Increased service life thanks to the use of state-of-the-art lubricants in the ratchet mechanism
- Locking function of the lever prevents unwanted switching
- Ergonomic shift lever and release button
- Surface: with protective insulation
- IEC 60900
- Protective insulation up to 1000 V
- For manual operation

NEW!

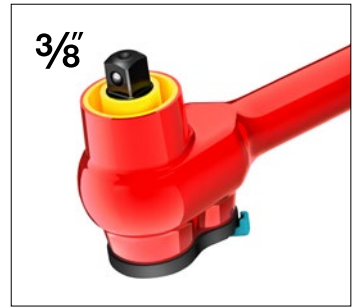

Made in Germany
8816HPKV
EAN-No. 4000896239184



HiPer
HIGH PERFORMANCE
THE ORIGINAL
MADE IN GERMANY

179NX-7-RAL3020 with 70 expert tools with protective insulation

70



Stainless steel work surface
EDELSTAHL®
Rostfrei

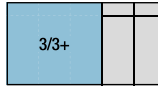

Assortment



Made in Germany
785 mm
518 mm

179NX-7/70KV
EAN-No. 4000896235483

163-545/41



163-172x50



163-542/18



163-172x50

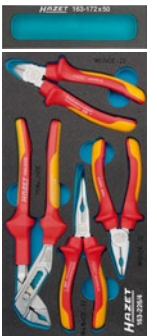

163-229/7

163-226/4

3/8", 1/2" high-voltage torque wrench, with protective insulation

- Can be calibrated
- Long service life – high precision
- Right/left release within the specified tolerance
- Adjustment, possible repairs with removal/installation of the KV torque wrench only in the HAZET service centre



Made in Germany

HAZET No.	Output	Nm range	Release accuracy tolerance %	l mm	EAN-No. 4000896 +
5108KV	10 3/8"	2 – 10	6	275	235421
5109KV	10 3/8"	5 – 25	4	305	235445
5121KV	12 1/2"	20 – 120	4	420	233397

3/8" high-voltage tool set, with protective insulation

- Joint development with one of the leading car manufacturers and in accordance with the German TÜV SÜD
- Surface: with protective insulation



For hybrid and electric vehicles!



150/52
EAN-No. 4000896247578

3/8" high-voltage tool set, with protective insulation

- Universally applicable for all work on high-voltage systems in trade · industry · electric and hybrid vehicles
- Produced according to current DIN specifications – optimum protection and highest level of safety thanks to constant quality control
- Recess for retrofitting with 3/8" torque wrench, with protective insulation 5109 KV (see page 24)



Universally applicable for all work on high-voltage systems in trade and industry as well as on electric and hybrid vehicles!



150/27
EAN-No. 4000896245550

Insulating mat

- For working on high-current parts
- Rubber mat, tested: 50,000 V, according to VDE 0303
- One side smooth and one side anti-slipping, grooved
- Dimensions: 1000 x 1000 x 4.0 mm
- Carrying strap removable



Made in Germany
196VDE-8/2
EAN-No. 4000896174836

Multimeter

- For measuring voltage, resistance, frequency, capacity and temperature
- Including measuring tips for clipping into the protective cover



2152-600
EAN-No. 4000896246762

High-voltage screwdriver set for electricians, with protective insulation

- Ergonomically shaped HAZET 2-component handle (red/yellow)
- Voltmeter (839-1), 220 – 250 V according to DIN VDE 06800-6



810/6VDE
EAN-No. 4000896179329

- 810VDE 0.4x2.5 · 0.6x3.5 · 0.8x4 mm
- 810VDE PH 1 · PH 2
- 839-1 0.5x2.8 mm

Screwdriver set, with protective insulation

- All screwdrivers 10,000 volts individually tested, safe working guaranteed up to 1000 volts
- Round blade



804VDE/14
EAN-No. 4000896133000



- 2.5x0.4 · 3.0x0.5 · 3.5x0.6 · 4.0x0.8 · 5.5x1.0 · 6.5x1.2 mm
- PH1 · PH2
- PZ2
- T10 · T15 · T20

HIPER FINE-TOOTH REVERSIBLE RATCHETS

- ▶ Complete range: 1/4" · 3/8" · 1/2"
- ▶ 10 versions, extendable or with safety lock, among other features
- ▶ Maximum power: almost double DIN (916HP: 1,000 Nm, DIN: 512 Nm)
- ▶ High precision: 90 teeth
- ▶ 4° operating angle for restricted spaces
- ▶ Developed and produced by HAZET "Made in Germany"



6.3 1/4 10 3/8 12.5 1/2



90
4°



Our classics!

Made in Germany

HAZET No.	■	Nm	l mm	EAN-No. 4000896 +
① 863HPB	6.3 1/4	120	116	235346
② 863HP	6.3 1/4	120	116	226917
③ 8816HP	10 3/8	400	200	235063
④ 916HP	12.5 1/2	1,000	275	213894
⑤ 916HPL	12.5 1/2	1,000	415	219209
⑥ 916HPLG	12.5 1/2	1,000	414 – 614	233076

With safety locking!

Made in Germany

HAZET No.	■	Nm	l mm	EAN-No. 4000896 +
⑦ 863HPS	6.3 1/4	100	116	237234
⑧ 8816HPS	10 3/8	340	200	237241
⑨ 916HPS	12.5 1/2	850	275	237258

- Loosening-proof locking thanks to push button actuation
- Attached tools can easily be released by pressing the button with just one hand

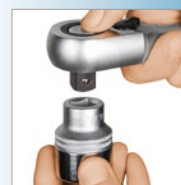

Short design!

Made in Germany

HAZET No.	■	Nm	l mm	EAN-No. 4000896 +
⑩ 916HPK	12.5 1/2	400	200	244379

- Short 1/2" design, only 200 mm in compact design as a 3/8" ratchet

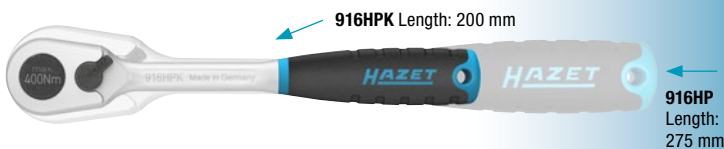

1/4" solid steel fine-tooth reversible ratchet for screwdriver bits

- 90 mm short style
- 60 teeth, 6° operating angle
- With locking spring to securely hold the screwdriver bits

60
6°

6.3 1/4

Comparison 863MB (length: 90 mm) to 863HP (length: 116 mm)

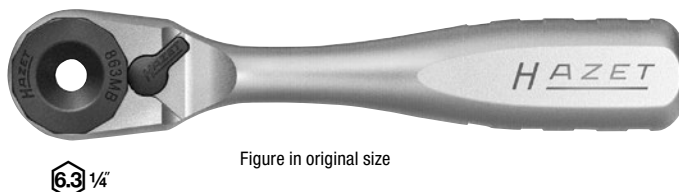

Figure in original size

Made in Germany
863MB
EAN-No. 4000896212187

OUR WORKSHOP CLASSICS!

- ▶ Large measuring range: 1 – 800 Nm
- ▶ 15 versions with **1/4" · 3/8" · 1/2" · 3/4"** reversible ratchet and reversible ratchet for screwdriver bits or insert square 9 x 12 · 14 x 18 mm
- ▶ Accuracy $\pm 3\%$ of the scale value ($5107 \pm 4\%$) in direction of actuation
- ▶ Tested according to DIN EN ISO 6789-2:2017 with calibration certificate and serial number
- ▶ HAZET's own service centre for best aftersales service
- ▶ Developed and produced by HAZET "Made in Germany"



Made in Germany



With reversible ratchet!

SYSTEM 5000-3CT

6.3 1/4" 10 3/8" 12.5 1/2" 20 3/4"



5120-3CT
1/2" ratchet in 3/8" length

Made in Germany

HAZET No.	Output	Nm Range	Release accuracy tolerance \pm %	l mm	EAN-No. 4000896 +
5107-3CT	6.3 1/4"	1 – 9	4	234	218875
5108-3CT	6.3 1/4"	2.5 – 25	3	234	218882
5110-3CT	10 3/8"	10 – 60	3	320	218899
5111-3CT	10 3/8"	20 – 120	3	375	235384
5120-3CT	12.5 1/2"	10 – 60	3	320	218905
5121-3CT	12.5 1/2"	20 – 120	3	421	218912
5122-3CT	12.5 1/2"	40 – 200	3	519	219001
5123-3CT	12.5 1/2"	60 – 320	3	628	218998
5143-3CT	12.5 1/2"	100 – 400	3	790	235407
5145-3CT	20 3/4"	300 – 800	3	1271	218929

No more turning back!



Setting instructions



With 1/4" reversible ratchet for screwdriver bits!

SYSTEM 5000-3CT

6.3 1/4"

Made in Germany

HAZET No.	Output	Nm Range	Release accuracy tolerance \pm %	l mm	EAN-No. 4000896 +
5107B-3CT	6.3 1/4"	1 – 9	4	234	244584
5108B-3CT	6.3 1/4"	2.5 – 25	3	234	244591



With plug connection!

SYSTEM 5000-3CT

9 x 12 14 x 18

Made in Germany

HAZET No.	Output mm	Nm Range	Release accuracy tolerance \pm %	l mm	EAN-No. 4000896 +
5280-3CT	9x12	2.5 – 25	3	218	239290
5290-3CT	9x12	10 – 60	3	291	228904
5292-3CT	14x18	40 – 200	3	484	228911

Effective length calculation



Effective length calculator



PROVEN HAZET HiPer TECHNOLOGY: NOW ALSO IN THE TORQUE WRENCH SYSTEM 6000-1CT!

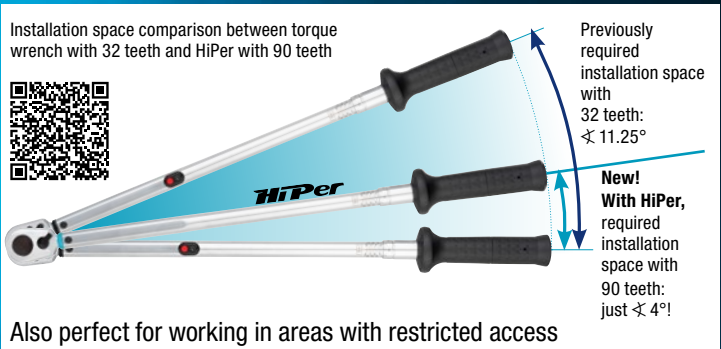
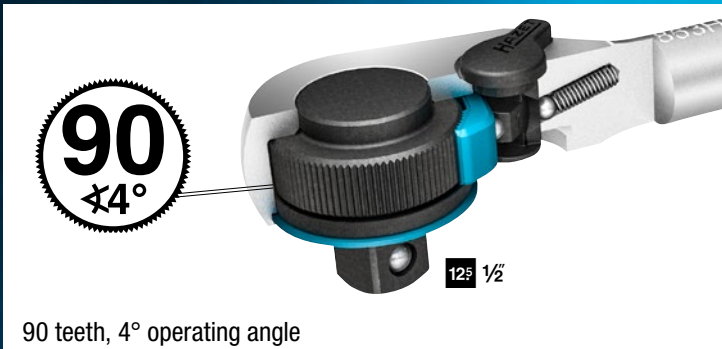

6.3 1/4 10 3/8 125 1/2



NEW SIZES IN 1/4" AND 3/8"!

**HiPer technology:
the highest degree of
precision in a wrench!**

HAZET No.	Output	Nm Range	Release accuracy tolerance %	l mm
6106-1CT	6.3 1/4	1 – 6	± 4	197
6108-1CT	6.3 1/4	2 – 10	± 2	198
6109-2CT	6.3 1/4	4 – 40	± 2	256
6110-1CT	10 3/8	5 – 60	± 2	335
6111-1CT	10 3/8	20 – 120	± 2	389
6121-1CT	125 1/2	20 – 120	± 2	437
6122-1CT	125 1/2	40 – 200	± 2	547
6123-1CT	125 1/2	60 – 320	± 2	661

NEW!



Max. loosening torque: 461 Nm

10 3/8"

- Compact design for work in confined spaces
- Single hammer striking mechanism
- Revolutions per minute: 6500
- Air requirement: 85.2 l/min
- Sound pressure level (at working pressure): 90.3 dB(A) Lp A
- Vibration acceleration: 7.78 m/s²
- Weight: 1.2 kg
- Housing length: 92 mm

Compact design!



9011M
EAN-No. 4000896201570

HAZET No.	Silicone protective cover	EAN-No. 4000896 +	
9012M-S	Suitable for 9011M	202232	

Max. loosening torque: 1200 Nm

125 1/2"

- Compact design for work in confined spaces
- Single hammer striking mechanism
- Revolutions per minute: 8800
- Air requirement: 127.4 l/min
- Sound pressure level (at working pressure): 92.2 dB(A) Lp A
- Vibration acceleration: 13.49 m/s²
- Weight: 1.3 kg
- Housing length: 81 mm

Extra short - Our top seller



9012M-1
EAN-No. 4000896218356

HAZET No.	Silicone protective cover	EAN-No. 4000896 +	
9012M-1-S	Suitable for 9012M-1	222735	

Max. loosening torque: 850 Nm

125 1/2"

- High performance pin clutch mechanism
- Revolutions per minute: 7000
- Air requirement: 127.4 l/min
- Sound pressure level (at working pressure): 92.1 dB(A) Lp A
- Vibration acceleration: 7.42 m/s²
- Weight: 2.6 kg
- Housing length: 178 mm



9012SPC
EAN-No. 4000896119639

HAZET No.	Silicone protective cover	EAN-No. 4000896 +	
9012SPC-S	Suitable for 9012SPC	222476	

Max. loosening torque: 1700 Nm

125 1/2"

- High performance twin hammer mechanism
- Revolutions per minute: 8000
- Air requirement: 139 l/min
- Sound pressure level (at working pressure): 98 dB(A) Lp A
- Vibration acceleration: 10.23 m/s²
- Weight: 1.9 kg
- Housing length: 162 mm



One-hand operation by changeover on rear of device

9012EL-SPC
EAN-No. 4000896188444

HAZET No.	Silicone protective cover	EAN-No. 4000896 +	
9012EL-SPC-S	Suitable for 9012EL-SPC	222520	

Twin Turbo

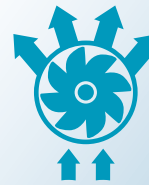

THE STRONGEST HAZET IMPACT WRENCH SERIES EVER!

- ▶ 1/2" · 3/4" · 1" Twin Turbo impact wrenches to 4,100 Nm power
- ▶ Twin Effect – More power in less time!
- ▶ Two air inlets and four air outlets
- ▶ 8-blade air motor with 25% higher impact performance ensures maximum torque
- ▶ HAZET's own service centre for best aftersales service



Extremely compact

Max. loosening torque: 550 Nm

- Recommended torque: 450 Nm
- Sound power level (at working pressure): 103.9 db(A) Lp W
- Sound pressure level (at working pressure): 92.9 dB(A) Lp A
- Vibration acceleration: 7.64 m/s²
- Revolutions per minute: 8000
- Air requirement: 113 l/min
- Loosening torque (max) determined with screw size M: 16
- Weight: 1.1 kg
- Housing length: 70 mm

12.5 1/2"

1/2"



9012PTT
EAN-No. 4000896252732

9012ATT compared with 9012PTT



Can be swivelled through 120°

Max. loosening torque: 550 Nm

- Recommended torque: 450 Nm
- Sound power level (at working pressure): 101.1 db(A) Lp W
- Sound pressure level (at working pressure): 90.1 dB(A) Lp A
- Vibration acceleration: 4.89 m/s²
- Revolutions per minute: 8000
- Air requirement: 113 l/min
- Loosening torque (max) determined with screw size M: 16
- Weight: 1.3 kg
- Housing length: 70 mm

12.5 1/2"

1/2"



9012ATT
EAN-No. 4000896234738



Short: only 128 mm

Max. loosening torque: 2200 Nm

- Recommended torque: 948 Nm
- Sound power level (at working pressure): 110.7 db(A) Lp W
- Sound pressure level (at working pressure): 99.7 dB(A) Lp A
- Vibration acceleration: 8.69 m/s²
- Revolutions per minute: 8300
- Air requirement: 147.2 l/min
- Loosening torque (max) determined with screw size M: 16
- Weight: 1.6 kg
- Housing length: 128 mm



1/2"

9012TT
EAN-No. 4000896226924



12.5 1/2"

3/4" impact wrench in 1/2" housing size

Max. loosening torque: 1890 Nm

- Recommended torque: 900 Nm
- Sound power level (at working pressure): 110.3 db(A) Lp W
- Sound pressure level (at working pressure): 99.3 dB(A) Lp A
- Vibration acceleration: 11.39 m/s²
- Revolutions per minute: 8000
- Air requirement: 150 l/min
- Loosening torque (max) determined with screw size M: 26
- Weight: 1.7 kg
- Housing length: 128 mm



9013MTT compared with 9013TT



3/4"

9013MTT
EAN-No. 4000896258062



NEW!

20 3/4"

Short: only 184 mm

Max. loosening torque: 4100 Nm

- Recommended torque: 1890 Nm
- Sound power level (at working pressure): 110.5 dB(A) Lp W
- Sound pressure level (at working pressure): 99.5 dB(A) Lp A
- Vibration acceleration: 10.69 m/s²
- Revolutions per minute: 5200
- Air requirement: 243.5 l/min
- Loosening torque (max) determined with screw size M: 32
- Removable handle, 360° adjustable
- Weight: 4.5 kg
- Housing length: 184 mm



3/4"



20 3/4"

9013TT

EAN-No. 4000896227143

Long spindle: 186 mm

Max. loosening torque: 3800 Nm

- Recommended torque: 1758 Nm
- Sound power level (at working pressure): 113.5 dB(A) Lp W
- Sound pressure level (at working pressure): 102.5 dB(A) Lp A
- Vibration acceleration: 9.02 m/s²
- Revolutions per minute: 5200
- Air requirement: 243 l/min
- Loosening torque (max) determined with screw size M: 32
- Removable handle, 360° adjustable
- Weight: 5.5 kg
- Housing length: 184 mm
- Length of spindle: 186 mm



3/4"



20 3/4"

9013LGTG

EAN-No. 4000896232277

Strong and handy

Max. loosening torque: 4100 Nm

- Recommended torque: 1898 Nm
- Sound power level (at working pressure): 112.9 dB(A) Lp W
- Sound pressure level (at working pressure): 101.9 dB(A) Lp A
- Vibration acceleration: 19.11 m/s²
- Revolutions per minute: 5200
- Air requirement: 235 l/min
- Loosening torque (max) determined with screw size M: 32
- Removable handle, 360° adjustable
- Weight: 4.6 kg
- Housing length: 184 mm



1"



25 1"

9014TT

EAN-No. 4000896234684

Long spindle: 240 mm

Max. loosening torque: 3850 Nm

- Recommended torque: 1627 Nm
- Sound power level (at working pressure): 113.5 dB(A) Lp W
- Sound pressure level (at working pressure): 102.5 dB(A) Lp A
- Vibration acceleration: 17.31 m/s²
- Revolutions per minute: 4600
- Air requirement: 235 l/min
- Loosening torque (max) determined with screw size M: 32
- Removable handle, 360° adjustable
- Weight: 5.9 kg
- Housing length: 184 mm
- Length of spindle: 240 mm



1"



25 1"

9014LGTG

EAN-No. 4000896234677

Max. loosening torque: 54 Nm

- With the open 17 mm inside hexagon it is also possible to work on extra long threads
- Can be used for $\frac{3}{8}$ " and $\frac{1}{2}$ " by replacing the ratchet heads
- Sound power level (at working pressure): 93.4 db(A) Lp W
- Sound pressure level (at working pressure): 82.8 dB(A) Lp A
- Vibration acceleration: 1.80 m/s²
- Revolutions per minute: 400
- Air requirement: 84 l/min
- Weight: 0.48 kg
- Length: 160 mm



17 mm



Mini and multifunction

4

9023M-1
EAN-No. 4000896227112



Max. loosening torque: 40 Nm

- For manual retightening with torque values > 60 Nm
- Sound power level (at working pressure): 101 db(A) Lp W
- Sound pressure level (at working pressure): 90 dB(A) Lp A
- Vibration acceleration: 3.30 m/s²
- Revolutions per minute: 250
- Air requirement: 72 l/min
- Weight: 0.5 kg
- Length: 150 mm



1/4"

6.3 1/4"

1/4" mini version

9020P-2
EAN-No. 4000896184323



Max. loosening torque: 54 Nm

- For manual retightening with torque values > 260 Nm
- Sound power level (at working pressure): 103 db(A) Lp W
- Sound pressure level (at working pressure): 92 dB(A) Lp A
- Vibration acceleration: 3.90 m/s²
- Revolutions per minute: 300
- Air requirement: 103 l/min
- Weight: 0.5 kg
- Length: 150 mm



3/8"

10 3/8"

3/8" mini version

9021P-2
EAN-No. 4000896184545



Max. loosening torque: 108 Nm

- For manual retightening with torque values > 400 Nm
- Sound power level (at working pressure): 110 db(A) Lp W
- Sound pressure level (at working pressure): 99 dB(A) Lp A
- Vibration acceleration: 9.10 m/s²
- Revolutions per minute: 280
- Air requirement: 113 l/min
- Weight: 1.24 kg
- Length: 258 mm



1/2"

12.5 1/2"

Closed head

9022P-2
EAN-No. 4000896184538



Max. loosening torque: 102 Nm

- For manual retightening with torque values > 270 Nm
- Sound power level (at working pressure): 98 db(A) Lp W
- Sound pressure level (at working pressure): 91 dB(A) Lp A
- Vibration acceleration: 4.53 m/s²
- Revolutions per minute: 400
- Air requirement: 113 l/min
- Weight: 1.28 kg
- Length: 280 mm



1/2"

12.5 1/2"

Pin clutch mechanism

9022SR-1
EAN-No. 4000896170593

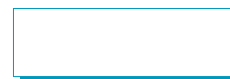

Max. loosening torque: 120 Nm

- For manual retightening with torque values > 400 Nm
- Sound power level (at working pressure): 102.2 db(A) Lp W
- Sound pressure level (at working pressure): 91.2 dB(A) Lp A
- Vibration acceleration: 4.87 m/s²
- Revolutions per minute: 200
- Air requirement: 107.6 l/min
- Weight: 1.55 kg
- Length: 285 mm



1/2"

12.5 1/2"

360° operating lever

9022-360
EAN-No. 4000896209781



Micro die grinder

- Power: 190 watts
- Collet chuck: 3 mm
- Revolutions per minute: 60000



Long service life thanks to Kevlar blades!

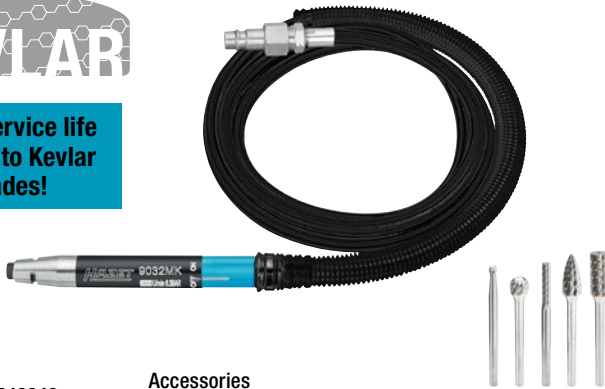

9032MK

EAN-No. 4000896248346

Accessories

HAZET No.	Carbide milling pin set	EAN-No. 4000896 +
9032-03/5	3 mm (5 pieces)	222483

Micro die grinder, angled

- Power: 186.4 watts
- Collet chuck: 3 mm
- Revolutions per minute: 70000



Long service life thanks to Kevlar blades!



9032M-53

EAN-No. 4000896246205

Accessories

HAZET No.	Carbide milling pin set	EAN-No. 4000896 +
9032-03/5	3 mm (5 pieces)	222483

Mini die grinder

- Power: 224 watts
- 6 mm collet chuck with 3 mm adapter to accommodate both grinding pad dimensions
- Revolutions per minute: 30000

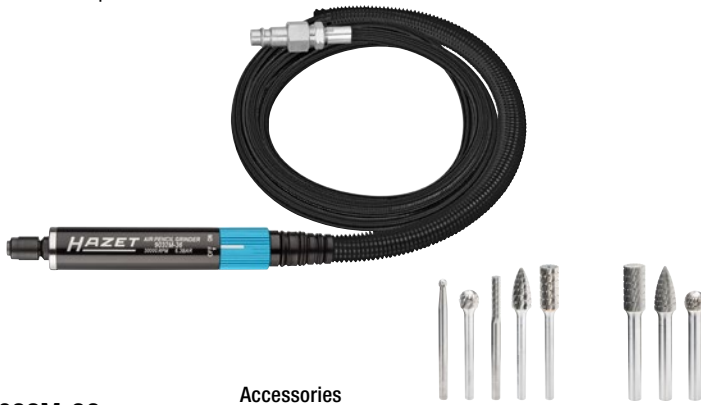

9032M-36

EAN-No. 4000896209606

Accessories

HAZET No.	Carbide milling pin set	EAN-No. 4000896 +
9032-03/5	3 mm (5 pieces)	222483
9032-06/3	6 mm (3 pieces)	222667

Engraving pen

- Power: 186.4 watts
- Precise and lasting marking (theft protection, installation date, etc.) on workpieces (up to HRC55) · metals · stone · ceramics · plastics
- Revolutions per minute: 13000

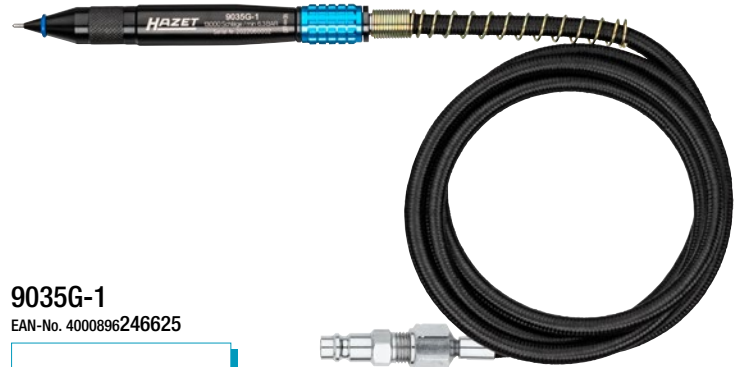

9035G-1

EAN-No. 4000896246625

Die grinder, straight design

- Power: 224 watts
- Lightweight, handy device for grinding, polishing, burnishing and deburring
- Revolutions per minute: 2000–25000



9032N-1

EAN-No. 4000896189359

Die grinder, angled

- Power: 224 watts
- Grinding, polishing, burnishing and deburring, particularly in areas that are difficult to access
- Continuous speed regulation via setting wheel on the upper side of the device
- Collet chuck: 6 mm
- Revolutions per minute: 2000–20000



9032N-5

EAN-No. 4000896198788

Belt sander

- Power: 417.6 watts
- Incl. hex-head wrench for fine adjustment of the belt and angle setting in the handle
- Revolutions per minute: 19000



9033N-4
EAN-No. 4000896210183

Abrasive belts



HAZET No.	Spare parts	■	EAN-No. 4000896 +
9033-480/10	Abrasive belt set, grain size 80	10	139101
9033-4100/10	Abrasive belt set, grain size 100	10	139118
9033-4120/10	Abrasive belt set, grain size 120	10	139125

Right-angle grinder

- Power: 671 watts
- For grinding wheels 0.8–6 mm thick
- Revolutions per minute: 12000



9033N-7
EAN-No. 4000896205547

HAZET No.	Spare parts	■	EAN-No. 4000896 +
9233-010/5	Cut-off wheel set (125x1 x 22.23 mm)	5	219063
9233-010/25	Cut-off wheel set (125x1 x 22.23 mm)	25	219070
9233-011/10	Rough grinding wheel set (125x6x22.23 mm)	10	219087

Angle grinder

- Power: 700 watts
- Revolutions per minute: 14000



9033P-8
EAN-No. 4000896190515



HAZET No.	Spare parts	■	EAN-No. 4000896 +
9033P-08/5	Cut-off wheel set	5	201549
9033P-08/25	Cut-off wheel set	25	201402

Cut-off grinder

- Power: 522 watts
- For cut-off wheels 76 x 2.1 x 10 mm
- Including 1 cut-off wheel
- Revolutions per minute: 2000–18000



9033-10
EAN-No. 4000896196371



HAZET No.	Spare part	■	EAN-No. 4000896 +
9033-010/5	Cut-off wheel set	5	199969

Orbital sanders

- Power: 375 watts
- Dust extraction
- Suction hose (2.0 m) and collection bag included
- Grinding disc with 15 bore holes, Ø 150 mm with hook and loop fastener
- Air requirement: 57 l/min
- Weight: 0.9 kg
- Length: 231 mm



9033-2
EAN-No. 4000896156337



HAZET No.	Spare parts	■	EAN-No. 4000896 +
9033-180/10	Grinding pad set, grain size 80	10	139330
9033-1100/10	Grinding pad set, grain size 100	10	139347
9033-1120/10	Grinding pad set, grain size 120	10	139354
9033-1150/10	Grinding pad set, grain size 15	10	139361
9033-020	15-hole grinding disc, Ø 150 mm with 5/16" thread	10	156351

Mini polisher

- Power: 224 watts
- Heavy-duty multi-bearing gearbox with a 2.5-times longer service life compared to conventional gearboxes
- Grinding disc: \varnothing 50 mm



9033M-9

EAN-No. 4000896227235



Mini disc sander, angled

- Power: 224 watts
- Heavy-duty multi-bearing gearbox with a 2.5-times longer service life compared to conventional gearboxes
- Roloc® quick-change system: Combines with many abrasive media
- Grinding disc: \varnothing 50 mm
- Weight: 0.44 kg
- Length: 133 mm



9033M-11

EAN-No. 4000896227129



Bristle grinder set

- For using with various grinding media to remove rust, paint, adhesive and sealing residues or to clean metal surfaces and weld seams when using various abrasive media
- Roloc™ quick-change system allows the abrasive media to be changed quickly and easily without needing to use any extra tools



9033-11/17

EAN-No. 4000896222575



17 pieces

- Sound power level (at working pressure): 86 db(A) Lp W
- Sound pressure level (at working pressure): 75 dB(A) Lp A
- Vibration acceleration: 3.11 m/s²
- Revolutions per minute: 15000
- Air requirement: 79 l/min
- Weight: 0.54 kg
- Length: 112 mm
- Height: 152 mm

17



HAZET No.	Spare parts	🔌	EAN-No. 4000896 +
9033-11-015	① Bristle grinding disc, 1/4" UNC Roloc®, \varnothing 50 mm	1	222841
9033-11-020/4	② Strip wheel set, \varnothing 50.8 mm Roloc®, hard version	4	222834
9033-11-030/4	③ Strip wheel set, \varnothing 50.8 mm Roloc®, soft version	4	222728
9033-11-036/2	④ Spare bristle grinder set, purple, \varnothing 50 mm Roloc®, grain size: 36	2	222872
9033-11-050/2	⑤ Spare bristle grinder set, green, \varnothing 50 mm Roloc®, grain size: 50	2	222865
9033-11-0120/2	⑥ Spare bristle grinder set, white, \varnothing 50 mm Roloc®, grain size: 120	2	222858

Mini orbital sander set

- Power: 238 watts
- With hook and loop fastener
- Revolutions per minute: 15000

36-piece set, contents:

- 1 orbital sander
- 1 grinding disc 50 mm (2")
- 1 grinding disc 75 mm (3")
- 10 grinding pads each, grain size 320
- 10 grinding pads each, grain size 400
- 10 grinding pads each, grain size 600
- 1 adjusting wrench
- 1 hook and loop fastener
- 1 air inlet nipple 9000-010

36



9033N-5

EAN-No. 4000896205585



Mini polisher set

- Power: 238 watts
- Revolutions per minute: 3200

6-piece set, contents:

- 1 polisher
- 1 wet grinding pad, \varnothing 75 mm
- 1 plastic pad, hard (yellow)
- 1 plastic pad, soft (white)
- 1 lambskin
- 1 adjusting wrench

6



9033N-9

EAN-No. 4000896205561



Vibration chisel set

- Vibration applications on screw connections seized by rust
- Strike rate adjustable in 9 levels up to 2600 strikes/min
- Including keyless drill chuck
- Length: 211 mm
- Height: 189 mm



9035V/5

EAN-No. 4000896213368

HAZET No.	Spare parts	■	EAN-No. 4000896 +
9035V-01	Semi-circular vibration chisel	1	214181
9035V-02	Circular vibration chisel	1	214174
9035V-03	Vibration chisel	1	214167
9035V-04	Vibration chisel	1	214150

More vibration chisels

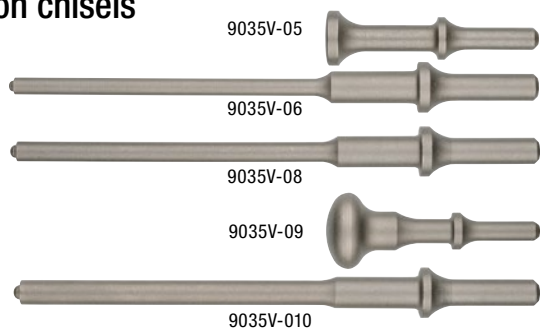

Chisel hammer set

- Detaching car body sheets with compressed air and for industrial application
- Strike rate adjustable in 9 levels up to 2600 strikes/min
- Including keyless drill chuck
- Length: 211 mm
- Height: 189 mm



9035H/6

EAN-No. 4000896214655

HAZET No.	Spare parts	■	EAN-No. 4000896 +
9035H-01	Flat chisel	1	214136
9035H-02	Sheet metal cutting chisel	1	213924
9035H-03	Pointed chisel	1	214198
9035H-04	Rivet cutting chisel	1	214143
9035H-05	Curve cutting chisel	1	214525

Sabre saw

- Support frame, adjustable in height, suitable for double-walled sheet steel
- Increased efficiency with reduction of weight, air consumption, noise generation and vibration
- Direction of air exhaust adjustable
- Suitable for cutting small radii
- Cutting capacity aluminium: 4 mm
- Cutting capacity sheet steel: 3 mm
- Strokes/min.: 9500
- Particularly suitable for cleaning sensor modules etc., due to file blade socket (included in delivery)



9034P-2

EAN-No. 4000896218288

HAZET No.	Designation	■	EAN-No. 4000896 +
9034P-R/5	Reciprocal saw blades, chamfered teeth, length: 153 mm	5	218318
9034P-050/5	File set, length: 153 mm	5	218349
9034P-018/5	Saw blades, 93 mm, 18 teeth	5	225958
9034P-024/5	Saw blades, 93 mm, 24 teeth	5	225965
9034P-032/5	Saw blades, 93 mm, 32 teeth	5	225989

Mini needle scaler

- With adjustable needle carriage
- Gentle cleaning of soiled, rusted parts especially for cleaning of brake systems etc.
- 28 mm slim / short pin form and free needles allow you to reach difficult to access areas as well
- Air outlet can be adjusted by 360°
- 13 thin stainless steel needles (∅ 1.3 mm) ensure damage-free processing and highly fine surface structure
- Suitable for processing stainless steel
- 3000 impacts/min
- Safety lever
- Infinite adjustable power
- Air connection inlet: inside thread 12.91 mm (1/4")
- Coupler plug: nominal size 7.2 (included)
- Sound power level (at working pressure): 98.8 db(A) Lp W
- Vibration acceleration: 6.90 m/s²
- Cold insulated handle
- Length: 235.6 mm
- Sound pressure level (at working pressure): 87.9 dB(A) Lp A
- Air requirement l/min: 48.1 l/min



NEW!

With air outlet adjustable by 360°

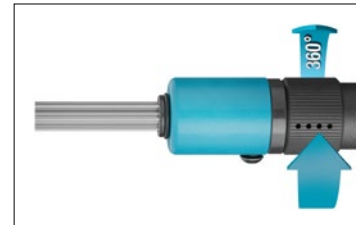

Adjustable needle carriage with integrated needle guide ensures long service life

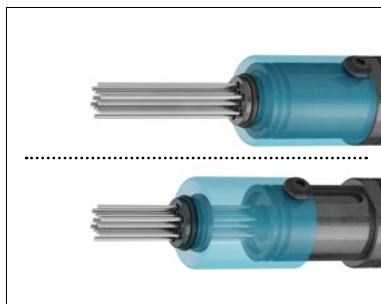

9035M-6
EAN-No. 4000896258109

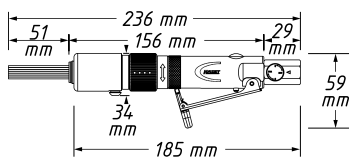

HAZET No.	Designation		EAN-No. 4000896+
9035M-050	Spare needles for mini needle scaler 9035 M-6, ∅ 1.3 mm	13	233205

Needle scaler

- Precisely removing rust and such
- Pistol shape
- Adjustable needle cover enables maximum utilisation of needles
- Two-piece housing design for easy maintenance
- 19 needles, ∅ 3 mm
- 3,200 impacts/min
- Length: 321 mm



9035-5
EAN-No. 4000896132355

HAZET No.	Designation		EAN-No. 4000896+
9035-050	Spare needles for needle scaler 9035-5, ∅ 3 mm	19	139385

Blind rivet gun

- Pneumatic / hydraulic
- Possible rivet sizes:
 - Aluminium rivets: 2.4–4.8 mm
 - Steel rivets: 2.4–4.8 mm
 - Stainless steel rivets: 2.4–3.2 mm
- 4 nose pieces (one pre-installed): 2.4 · 3.2 · 4 · 4.8 mm
- Length: 270 mm



9037SPC
EAN-No. 4000896150168

Detailed information



Air blow and suction gun, switchable

- Sucking up dirt into the collection bag as well as for blowing surfaces clean
- Deflector special bag insert protects the bag against damage, e. g. due to swarfs, by preventing direct impact of the accelerated swarfs
- One-hand reversing switch
- Metal housing
- Vacuum level: 7.5 mmHg

Incl. accessories



HAZET No.	Spare parts	Quantity	EAN-No. 4000896+
9043N-10-07/2	Dust bag set	2	202607
9043N-10-08/2	Fine dust bag set	2	222827



9043N-10
EAN-No. 4000896198382

Wash-gun set

- Effective, powerful and solvent-free cleaning of e.g. cooling systems with graduated system cleaning nozzle
- Cleaning without the use of aggressive chemicals or solvents
- Swivel joint at the water connection, helps to avoid "hose spaghetti"
- Continuous independent regulation of water and compressed air supply
- Temperature range -10°C / +40°C
- **Contents:**
 - Water connection variants: 13 mm (1/2") nipple for water coupling (Gardena system compatible) or 20 mm (3/4") GHT thread
 - Graded system cleaning nozzles
 - Jet washing nozzle



9048P-2/3
EAN-No. 4000896234608

Car body gun

- For underbody protection and cavity sealing
- Suitable for aqueous and oily liquids
- Including metal intake pipe, nozzle and cavity tube
- Temperature range: -10°C – 80°C
- Max. working pressure: 16 bar
- Length: 251 mm



9042P-4
EAN-No. 4000896209613

Air blow gun, long



9040LG-3/2
EAN-No. 4000896206339

Nozzles for long air blow gun:

Venturi nozzle

- 100% increase in air outlet quantity thanks to Venturi effect
- For 9040-4 and 9040 LG-3/2



9040LG-3-01
EAN-No. 4000896241514

Lateral nozzle 90°

- Nozzle enables lateral blow-out, e.g. for cleaning cooling fins and other hard-to-reach areas
- For 9040-4 and 9040 LG-3/2



9040LG-3-02
EAN-No. 4000896241521

Turbo air blow gun

- Cleaning of soiled surfaces such as upholstery surfaces, dirt from wheel housings, floor mats from animal hair as well as for vehicle preparation, rim and parts cleaning with compressed air and as preparatory cleaning work for the removal / installation of parts
- Swirl nozzle generates a strong air pulse for cleaning even stubborn soiling
- To be used on machinery, vehicles, in workshops, for wood work, in hobby workshops
- Highly practical design
- Air inlet: inside thread 12.91 mm (1/4")
- Coupler plug: nominal size 7.2 (included)
- Hose diameter (recommended): 10 mm
- Max. pressure: 12 bar
- Sound pressure level (at working pressure): 91 dB(A) Lp A
- Sound power pressure (at working pressure): 102 dB(A) Lp W
- Air requirement: 80 l/min (at working pressure)
- Length: 150 mm



Plastic housing protects against scratches



9040T-1

EAN-No. 4000896252626



Extremely effective due to swirled air impact!



Standard nozzle

- Curved tube: \varnothing 8 mm, 100 mm
- Temperature range: -10°C to 80°C
- Max. working pressure: 16 bar
- Length: 247 mm

9040P-1

EAN-No. 4000896209545



Long nozzle

- Straight tube: \varnothing 8 mm, 300 mm
- Temperature range: -10°C to 80°C
- Max. working pressure: 16 bar
- Length: 420 mm

9040P-2

EAN-No. 4000896209552

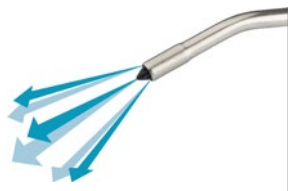

Low noise

- Curved tube: \varnothing 8 mm, 100 mm
- Non-blocking
- Temperature range: -10°C to 80°C
- Max. working pressure: 12 bar
- Length: 255 mm

9040P-3

EAN-No. 4000896209644

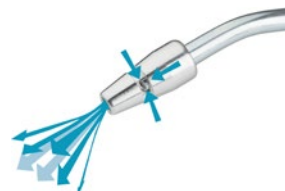

Venturi nozzle

- Curved tube: \varnothing 8 mm, 100 mm
- 100% increase in air outlet quantity thanks to Venturi nozzle
- Temperature range: -10°C to 80°C
- Max. working pressure: 16 bar
- Length: 265 mm

9040P-4

EAN-No. 4000896209569

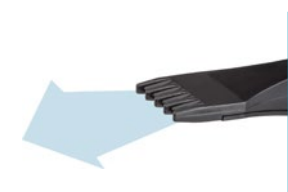

Broad, flat nozzle

- Considerable blowing force
- Non-blocking
- Temperature range: -10°C to 80°C
- Max. working pressure: 8 bar
- Length: 203 mm

9040P-5

EAN-No. 4000896209576



2-way air blow gun with replaceable nozzle

- Choice of air supply at tool head or handle
- Exchangeable nozzles:
 - Short nozzle for areas with restricted access
 - Long nozzle (112 mm) with safety nozzle tip (scratch protection)
- Max. working pressure: 10 bar

9040-4

EAN-No. 4000896176236

Open hose reel

- Allows visual inspection of the hose
- Automatic hose reel offers tidiness in the workshop – Hose not left lying around, thus reducing the risk of accidents
- Open design against accumulation of dirt
- For compressed air
- Inside diameter of the hose: 10 mm
- Hose length: 20 m
- Max. working pressure: 12 bar
- Spring return with ratchet locking holders
- Including sturdy swivel base
- Integrated roller inlet
- Hybrid polymer hose, black
- Length of connection hose: 1 m
- Air inlet: outside thread 16.41 mm (3/8")
- Including German air connection nipple for air inlet 9000-015
- Can be used with HAZET safety clutch 9000-061
- Installation via metal bracket or swivel base (included)
- Including air inlet nipple 9000-015 (see page 41)
- Weight: 11.68 kg



Robust steel design with roller guide!

Swivel range: 180°

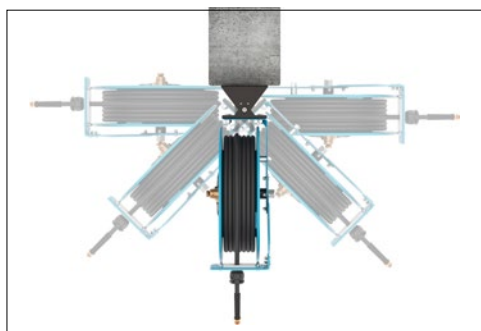

Solid steel construction



9040 OS-10

EAN-No. 4000896252602

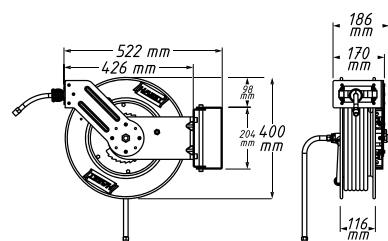

Hose reel

- For compressed air or water
- Max. working pressure: 20 bar
- Temperature range: -40°C to 60°C
- Hose length: 15 m
- Length of connection hose: 0.9 m
- Automatic guidance winds the hose neatly
- Braked winding to prevent risk of accidents
- Dimensions: 459 x 378 x 205 mm



Inside diameter of the hose: \varnothing 10 mm

- External thread: 16.41 mm 3/8"

9040N-10

EAN-No. 4000896206445



Inside diameter of the hose: \varnothing 13 mm

- External thread: 20.96 mm 1/2"

9040N-13

EAN-No. 4000896214648



Cable reel

- Including line circuit breaker
- Only suitable for indoor use
- 230 V AC
- Cable: H07RN-F 3 x 2.5 mm²
- Cable length: 20 m
- Connecting cable length: 1.5 m
- Automatic guidance winds the hose neatly
- Braked winding to prevent risk of accidents



9040D-2.5

EAN-No. 4000896214631



Spiral hose

- High flexible polyurethane hose
- Connecting pieces with 360° swivel joints
- Temperature range: -20°C to 60°C
- Hose length: 7.62 m
- Working pressure: 10 bar



HAZET No.	Inside diameter of the hose	EAN-No. 4000896+
9040-7	\varnothing 6.35 mm	153404
9040S-10	\varnothing 10 mm	212361



Grease gun

- Filling capacity: 400 ml

9042N-1

EAN-No. 4000896176472



Mini grease gun

- Filling capacity: 80 g

2162M

EAN-No. 4000896185634



High performance lubricant

- Grease cushion: 60 ml

Made in Germany

9300N-60

EAN-No. 4000896203406



Mini oiler

- Filling capacity: 28 ml

9070N-1

EAN-No. 4000896206407



Special pneumatic tool oil

- Filling capacity: 100 ml

Made in Germany

9400-100

EAN-No. 4000896191390



- Filling capacity: 1,000 ml

Made in Germany

9400-1000

EAN-No. 4000896191406



Compressed air quick coupling

- Extremely durable with a long service life
- For connecting compressed air to pneumatic tools
- Inside thread 16.41 mm / 5/8"
- One-hand operation – Easy operation, even with gloves
- Material: Steel, nickel-plated
- Working range: 0 – 15 bar

Full metal 5 in 1 quick coupling



NEW!

l mm	∅ mm
54.5	24



- For air connection nipples:
 - Germany (standard), Austria, Slovenia, Hungary, China, India, Portugal, Poland, Romania, Turkey NW7.2 Type Rectus corresponds to HAZET nipple 9000-010/3
 - Belgium, France, Netherlands, Switzerland, NW5.5 (Type Aro/Orion/ Milton A-Style) corresponds to HAZET nipple 9000-011/3
 - Arab countries, Italy, Spain HAZET Nipple 9000-012
 - Israel/USA corresponds to HAZET nipple 9000-013
 - Lincoln (US Automotive Lubrication System)

9001-061

EAN-No. 4000896258468



Safety coupling

- For air connection nipple 7.3 mm
- Working range: 0 – 20 bar
- Air inlet thread (internal thread): 16.41 mm (5/8")
- Suitable for hose reel 9040N-10



9000-061

EAN-No. 4000896195299



Safety coupling

- For air connection nipple 10 mm
- Working range: 0 – 50 bar
- Air inlet thread (internal thread): 20.95 mm (1/2")
- Suitable for hose reel 9040N-13



9000-062

EAN-No. 4000896218936



Rotary joint

- With continuous air flow rate reducer
- Air flow regulation by means of setting wheel
- 360° rotation joint in 2 axes
- Maximum pressure: 16 bar
- Air connection inlet: internal thread 12.91 mm 1/4"
- Air connection outlet: external thread: 12.91 mm 1/4"



9000-040

EAN-No. 4000896195350



Rotary joint

- 360° rotation joint in 2 axes
- Maximum pressure: 16 bar
- Air connection inlet: internal thread 12.91 mm 1/4"
- Air connection outlet: external thread 12.91 mm 1/4"



9000-041

EAN-No. 4000896204441



Compressed air reducer

- Reduction of working pressure to protect high-quality pneumatic equipment
- Max. inlet pressure: 10 bar
- Outlet pressure 6,3 bar
- Air connection inlet: internal thread 12.91 mm 1/4"
- Air connection outlet: external thread: 12.91 mm 1/4"



9000-080

EAN-No. 4000896214709



Air connection nipple

- For connecting our hose reels with 16.41 mm (3/8") coupler thread (outside) to type 1 compressed air couplings
- 16.41 mm (3/8") inside thread
- For air connection nipples:
 - Germany (standard), Austria, Slovenia, Hungary, China, India, Portugal, Poland, Romania, Turkey NW7.2 Type Rectus corresponds to HAZET nipple 9000-010/3



9000-015

EAN-No. 4000896253258



NEW!

**HAZET RECHARGEABLE BATTERY SYSTEM
SUITABLE FOR ALL DEVICES!**

Spare rechargeable battery, Li-ion

18 V · 2.5 Ah · charging time: 35 min

9212-02

EAN-No. 4000896213788



18 V · 5 Ah · charging time: 80 min

9212-05

EAN-No. 4000896210367



Quick charger

9212-03

EAN-No. 4000896204823



**1/2" cordless impact wrench set, 18 V
Maximum loosening torque: 260 Nm**

12⁵ 1/2 3

- Illumination of the work area before the output begins to move
- Extremely handy tool
- Light weight design
- Recommended torque: 200 Nm



- Set of 3 pieces in textile bag:
 - 1 cordless impact wrench
 - 1 quick charger
 - 1 Li-ion rechargeable battery 18 V, 2.5 Ah (35 minutes)

9212SPC-1

EAN-No. 4000896212439



HAZET No.	Designation	EAN-No. 4000896+
9212SPC-010	Basic unit (without rechargeable battery, without charger)	214273
9212SPC-1/4	4-piece set: 1 basic unit, 1 charger, 2 Li-ion rechargeable batteries 2.5 Ah	214259

**1/2" mini cordless
impact wrench set, 18 V
Maximum loosening torque:
270 Nm**

12⁵ 1/2 3

- Recommended torque: 220 Nm
- Brushless DC motor (BLDC)
- Three selectable power levels for torque tightening:
 - Level 1 100 Nm at 0 – 700 rpm (0 – 1200 impacts/min)
 - Level 2 190 Nm at 0 – 1600 rpm (0 – 2000 impacts/min)
 - Level 3 220 Nm at 0 – 2500 rpm (0 – 3200 impacts/min)



- Set of 3 pieces in textile bag:
 - 1 cordless impact wrench
 - 1 quick charger
 - 1 Li-ion rechargeable battery 18 V, 2.5 Ah (35 minutes)

9212M-1

EAN-No. 4000896212446



HAZET No.	Designation	EAN-No. 4000896+
9212M-010	Basic unit (without rechargeable battery, without charger)	214280
9212M-1/4	4-piece set: 1 basic unit, 1 charger, 2 Li-ion rechargeable batteries 2.5 Ah	214266

1/2" cordless impact wrench set, 18 V Maximum loosening torque: 700 Nm

- Recommended torque: 500 Nm
- Brushless DC motor (BLDC)
- Three selectable power levels for torque tightening:
 - Level 1 80 Nm at 0 – 600 rpm (0 – 1200 impacts/min)
 - Level 2 300 Nm at 0 – 1400 rpm (0 – 2500 impacts/min)
 - Level 3 500 Nm at 0 – 2000 rpm (0 – 3400 impacts/min)



HAZET No.	Designation	EAN-No. 4000896+
9212-010	Basic unit (without rechargeable battery, without charger)	221790
9212-3LB/4	4-piece set: cordless impact wrench 18 V, 1 charger, 2 Li-ion rechargeable batteries 5.0 Ah, in L-Boxx	244171

12 1/2 3



- Set of 3 pieces in L-Boxx:
 - 1 cordless impact wrench
 - 1 quick charger
 - 1 Li-ion rechargeable battery 18 V, 5 Ah (80 minutes)

9212-3LB/3
EAN-No. 4000896244164

1/2" cordless impact wrench set, 18 V Maximum loosening torque: 1400 Nm

- Max. tightening torque: 1000 Nm
- Brushless DC motor (BLDC)
- Three selectable power levels for torque tightening:
 - Level 1 180 Nm at 0 – 400 rpm (0 – 800 impacts/min)
 - Level 2 400 Nm at 0 – 800 rpm (0 – 1600 impacts/min)
 - Level 3 1000 Nm at 0 – 1800 rpm (0 – 2200 impacts/min)



HAZET No.	Designation	EAN-No. 4000896+
9212-1000	Basic unit (without rechargeable battery, without charger)	222711
9212-1000LB/4	4-piece set: 1 basic unit, 1 charger, 2 Li-ion rechargeable batteries 5.0 Ah in L-Boxx	249909

12 1/2 3



- Set of 3 pieces in L-Boxx:
 - 1 cordless impact wrench
 - 1 quick charger
 - 1 Li-ion rechargeable battery 18 V, 5 Ah (80 minutes)

9212-1000LB/3
EAN-No. 4000896249848

3/4" cordless impact wrench set, 18 V Maximum loosening torque: 1400 Nm

- Max. tightening torque: 1000 Nm
- Brushless DC motor (BLDC)
- Three selectable power levels for torque tightening:
 - Level 1 180 Nm at 0 – 400 rpm (0 – 800 impacts/min)
 - Level 2 400 Nm at 0 – 800 rpm (0 – 1600 impacts/min)
 - Level 3 1000 Nm at 0 – 1800 rpm (0 – 2200 impacts/min)



HAZET No.	Designation	EAN-No. 4000896+
9213-1000	Basic unit (without rechargeable battery, without charger)	222698
9213-1000LB/4	4-piece set: 1 basic unit, 1 charger, 2 Li-ion rechargeable batteries 5.0 Ah in L-Boxx	249862

20 3/4 3



- Set of 3 pieces in L-Boxx:
 - 1 cordless impact wrench
 - 1 quick charger
 - 1 Li-ion rechargeable battery 18 V, 5 Ah (80 minutes)

9213-1000LB/3
EAN-No. 4000896249886

Cordless drill set, 18 V

- Max. tightening torque: 60 Nm
- Brushless DC motor (BLDC)
- Selectable torque settings 15 + 1 drilling
- Vibration acceleration screwing: 0.8 m/s²
- Vibration acceleration drilling 2.3 m/s²
- Robust machine housing
- Suitable for continuous operation

- **Set of 3 pieces in textile bag:**
 - 1 cordless drill
 - 1 quick charger
 - 1 Li-ion rechargeable battery 18 V, 2.5 Ah (35 minutes)



Tool-free metal quick-clamping drill chuck 1-13 mm

9230-2

EAN-No. 4000896218370



HAZET No.	Designation	EAN-No. 4000896 +
9230-010	Basic unit (without rechargeable battery, without charger)	218974
9230-2/4	4-piece set: 1 cordless drilling machine, 1 quick charger, 2 Li-ion rechargeable batteries 18 V, 2.5 Ah	218967

Cordless right-angle grinder, 18 V

- Revolutions per minute: 8000
- Brushless DC motor
- Including 1 protective cover each
 - for cut-off wheels
 - for rough grinding wheels

- **3-piece set in case:**
 - 1 cordless right-angle grinder
 - 1 quick charger
 - 1 Li-ion rechargeable battery 18 V, 5 Ah (80 minutes)



Mesh fabric protects motor from dirt

9233-7

EAN-No. 4000896218325



HAZET No.	Designation	EAN-No. 4000896 +
9233-010	Basic unit (without rechargeable battery, without charger)	218943
9233-7/4	4-piece set: 1 cordless right-angle grinder, 1 quick charger, 2 Li-ion rechargeable batteries 18 V, 5.0 Ah	218950

Cordless reciprocating saw

- Support frame, adjustable in height, suitable for double-walled sheet steel
- Brushless DC motor
- Strokes/min.: 9500
- Wood cutting capacity: 200 mm
- Metal cutting capacity: 20 mm
- Tool-free saw blade quick-change system
- Quick adjustment of bars without tools

- **3-piece set in HAZET L-Boxx 136:**
 - 1 cordless reciprocating saw
 - 1 quick charger
 - 1 Li-ion rechargeable battery 18 V, 5 Ah (80 minutes)



9234-1

EAN-No. 4000896234714

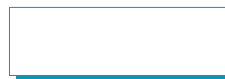

HAZET No.	Designation	EAN-No. 4000896 +
9234-010	Cordless reciprocating saw basic unit (without rechargeable battery, charger, L-Boxx and insert)	234707
9234-1/4	4-piece set: 1 cordless reciprocating saw, 1 quick charger, 2 Li-ion rechargeable batteries 18 V, 5.0 Ah in L-Boxx	234721

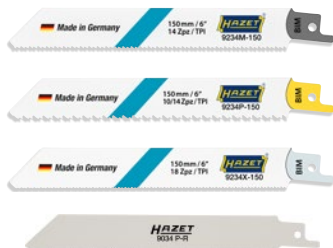

HAZET No.	5 flexible reciprocating saw blades each	Length of serration mm	EAN-No. 4000896 +
9234M-150/5	For steel and non-ferrous metal from 2 – 8 mm	130	239382
9234P-150/5	For wood with nails and faster sawing progress in metal 2 – 10 mm	130	239405
9234P-225/5	For wood with nails and faster sawing progress in metal 2 – 10 mm	205	239412
9234X-150/5	For steel and stainless steel (Inox) from 1.5 – 4 mm	130	239597
9234W-225/5	For all wood types, plastics as well as plasterboard 6 – 100 mm	205	239429
9034P-R/5	Reciprocating sabre saw blades	132	218318

Pressure sprayer

- Spraying with cleaning agents and disinfectants as well as for degreasing and lubrication
- Net volume: 1 l



199N-1
EAN-No. 4000896189007



Pressure foam sprayer

- Three nozzles (in scope of delivery) for generating wet and dry foams as well as for implementing different reaction times
- Net volume: 0.75 l



199-3
EAN-No. 4000896207237



Spray bottle, refillable

- Use with multi-purpose spray, such as e.g. penetrating oil, rust remover, as well as rim and brake cleaner
- Including 155 mm long jet nozzle and short spray nozzle
- Filling capacity: 0.23 l



199-4
EAN-No. 4000896198429



High performance suction gun

- Filling capacity: 500 ml



2162-4
EAN-No. 4000896174850



- Filling capacity: 1 l



2162-6
EAN-No. 4000896174454



Magnetic cup

- Ø 150 mm



197-3
EAN-No. 4000896158584



Magnetic holder

- Magnetic pull-off force: axial max. 18 kg



197-10
EAN-No. 4000896254392



Magnetic button set

- Magnetic pull-off force: max. 3 kg
- Contents: 3x magnetic buttons



197-11/3
EAN-No. 4000896255191



Magnetic holder

- Loading capacity: 10 kg
- Height: 400 mm
- Length: 140 mm



9070-10
EAN-No. 4000896158157



Working gloves

- High-quality goatskin



1987N-3
EAN-No. 4000896222650



1987N-4
EAN-No. 4000896203840



1987-5L
EAN-No. 4000896181735

1987-5XL
EAN-No. 4000896181759

1987-5XXL
EAN-No. 4000896181766

- In L, XL or XXL Each



1987-6
EAN-No. 4000896222643



Multifunctional drain pans

- Filling capacity: 6 l



197N-1
EAN-No. 4000896198924



- Filling capacity: 16 l



197-2
EAN-No. 4000896146802



- Filling capacity: 50 l



Made in Germany
197-50
EAN-No. 4000896210008



HAZET THERMAL CAMERAS – FOR OPTIMUM VIEWING CLARITY!



- Screen size: 2.4" LCD screen
- Display resolution: 320 x 240 pixels
- Thermal (or IR) resolution: 160 x 120 pixels
- Field of view: 37.2° x 50°
- Temperature measuring range: -20°C – 550°C (-4°F to 1,022°F)
- Battery life: up to 8 hours
- Dimensions (H x W x D): 196 x 117 x 59 mm
- Weight: 0.35 kg



Exchangeable SD card



Power supply: USB cable (Micro USB)



1992-1
EAN-No. 4000896244270



- Screen size: 3.5" LCD touchscreen
- Display resolution: 640 x 480 pixels
- Thermal (or IR) resolution: 256 x 192 pixels
- Field of view: 50° x 37.2°
- Temperature measuring range: -20°C – 400°C (-4°F to 752°F)
- Battery life: up to 4 hours
- Dimensions (H x W x D): 138.5 x 85.2 x 23.6 mm
- Weight: 0.22 kg

Detailed information



More detail through visual camera:
3,264 x 2,448 pixels (8MP)

Digital zoom 4 x

Touchscreen

Record videos

1992-2
EAN-No. 4000896249435



New:
Sturdy steel tube frame
with 2.4 mm material
thickness

NEW!



195N-3
EAN-No. 4000896256761

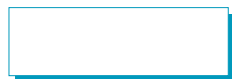

Creeper

- High capacity up to 150 kg (lying or sitting)
- 6 castors (∅ 63 mm)
- Combines creeper and seat
- Quick and easy conversion from creeper to seat and vice versa
- Cushioned reclined surface, lead part in HAZET blue
- Dimensions: lying position L 1198 x B 440 x H 135 mm, seat height 420 mm, seat surface 300 x 310 mm



Mechanic's creeper

- Ergonomically shaped: cut out arm areas for optimal elbow room
- Smooth-running swivel castors with rubber running surface, oil resistant and low-noise
- Practical carrying handle in the foot area
- Six castors made of hard plastic (∅ 70 mm)
- Practical storage compartments for tools and small parts on the right and the left
- Soft padded headrest
- Dimensions: L 1,030 x W 480 x H 115 mm

195N-2
EAN-No. 4000896252169

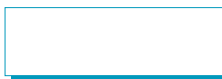

Mechanic's mat

- Dimensions: 975 x 385 x 30 mm

195-5
EAN-No. 4000896153718



Kneeling mat

- Dimensions: 450 x 210 x 30 mm

195-1
EAN-No. 4000896121069



HAZET VIDEO BORESCOPE WITH HD CAMERA – OPTIMUM DETAIL!

- ▶ Bright and sharper image
- ▶ Better details
- ▶ Clearer image



HD borescope set with front and side camera

5

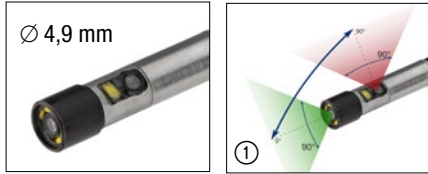

Front and side camera

Ø 4,9 mm

Switchable probe head



5-piece set in plastic case:

- Basic unit 4812-11G
- HD probe 4812-11FS
- SD card 32 GB
- Micro HDMI cable (A to D) 1.8 m
- USB-C cable (A to C) 1 m

4812-11/5FS
EAN-No. 4000896249572



HD touch screen borescope set with swivelling probe 180°

5

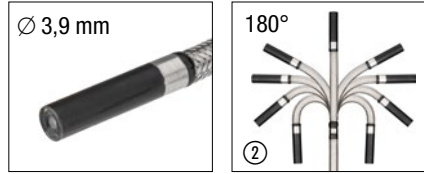

Ø 3,9 mm

Swivelling probe head



5-piece set in HAZET L-Boxx 136:

- Basic unit 4812-23G
- HD probe 4812-23AF
- SD card 64 GB incl. adapter
- Micro HDMI cable (A to D) 1.8 m
- USB-C cable (A to C) 1 m

Built-in microphone

Marking details of photos on the touchscreen – Creating folders

Split screen: Side-by-side display of recording and live image

4812-23/5AF
EAN-No. 4000896249824



	4812-11/5FS	4812-23/5AF
Camera probe	Ø 4.9 mm semiflexible probe with dual camera 90° and 180° (see picture ①)	Ø 3.9 mm probe with front camera can be swivelled up to 180° (articulation see picture ②)
Display	90 mm (3.5") large reflection-reduced LCD display	127 mm (5") large, sunlight-readable, reflection-reduced touch display
Zoom	1.5 x and 2 x	3 x
Display resolution	320 x 240 pixels	800 x 480 pixels
10-level brightness setting	(5 + 5 boost)	(5 + 5 boost)
Energy source	4 x AA battery alternative power supply via USB-C socket	Rechargeable Li-ion battery. Charging time: 3.5 h, operating time: 4 h
Image format (jpg)	1920 x 1080 pixels	1920 x 1080 pixels
Video format	MP4, 1920 x 1080 pixels (MOV format) with optional timestamp	MP4, 1920 x 1080 pixels (MOV format) with optional watermark, timestamp and audio
Data transfer	USB-C (access either to camera or as card reader)	USB-C (access either to camera or as card reader)
IP protection rating (basic unit)	IP54	IP54
Handling	With handle	Positioning via magnetic foot – enables hands-free inspection
Tripod thread	✓	✓
Mirroring of the camera image	✓	✓
Negative representation	✓	✓
Connectivity	Camera can be used via HDMI on the display or USB-C on the PC	Camera can be used via HDMI on the display or USB-C on the PC
PC software	✓	✓
Weight	370 grams without batteries	705 grams
Dimensions (L x W x H)	276 x 123 x 54 mm	162 x 128 x 46 mm

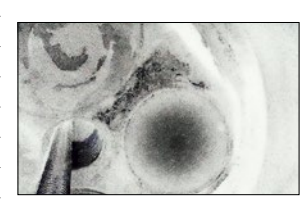

Negative representation



Wireless charging

NEW!

3

LED light set

Contents:

- 1 x 1979W-11 pen light
- 1 x 1979W-85 solid light
- 1979WP-2 charging pad for 2 lights
- Incl. 100 cm USB-C cable and 2 A / 5 V power supply unit



1979W2/3

EAN-No. 4000896258208



Wireless charging

3

LED pen light set

Contents:

- 2 x 1979W-11 pen light
- 1979WP-2 charging pad for 2 lights
- Incl. 100 cm USB-C cable and 2 A / 5 V power supply unit



1979W-11/3

EAN-No. 4000896235247



Wireless charging

3

LED light set

- Efficient and comfortable charging function due to optimised self-positioning of the lamp on the pad
- Wirelessly mobile and versatile, especially in extremely tight spaces

Contents:

- 1979W-82 LED pocket light
- 1979W-92 LED slim light
- 1979WP-2 charging pad for 2 lights
- Incl. 100 cm USB-C cable and 2 A / 5 V power supply unit

1979W1/3

EAN-No. 4000896241408



Wireless charging

3

LED inspection lamp set

Contents:

- 1979W-11 pen light
- 1979W-82 pocket light
- 1979WP-2 charging pad for 2 lights
- Incl. 100 cm USB-C cable and 2 A / 5 V power supply unit



1979NW/3

EAN-No. 4000896235261





Wireless charging

• Wireless charging of LED lights

Top light:
• 150 lm
• 11 h

Main light:
• 110 – 1100 lm
• 3 h

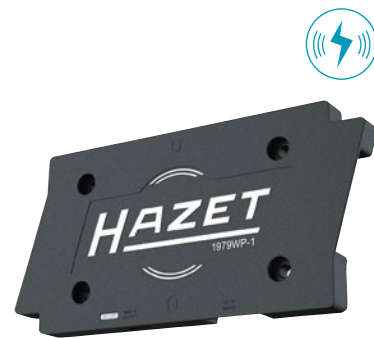

Charging pad for one light

1979WP-1
EAN-No. 4000896227952



Top light:
• 100 lm
• 5 h

Main light:
• 30 – 300 lm
• 2 h

LED pocket light
1979W-82

EAN-No. 4000896227228



Top light:
• 120 lm
• 4 h

Main light:
• 20 – 200 lm
• 2.5 h

LED pen light
1979W-11

EAN-No. 4000896235230



Top light:
• 300 lm
• 4.5 h

Main light:
• 60 – 600 lm
• 3 h

LED solid light
1979W-85

EAN-No. 4000896241484



LED slim light
1979W-92

EAN-No. 4000896241422



Charging pad for two lights

1979WP-2

EAN-No. 4000896227945



With charging cable

• Battery can be charged via a standard USB adapter 5 V maximum 1 A



• Delivery incl. 100 cm USB-C charging cable (without USB power supply unit)

Top light:
• 150 lm
• 11 h

Main light:
• 110 – 1100 lm
• 3 h

With batteries

• Incl. batteries: 1.5 V micro / AAA / (LR)03



• 130 lm
• 4 h

LED pen light

1979N-71
EAN-No. 4000896208470



Top light:
• 100 lm
• 5 h

Main light:
• 30 – 300 lm
• 2 h

LED pocket light
1979N-82

EAN-No. 4000896227211

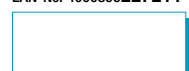

Top light:
• 120 lm
• 4 h

Main light:
• 20 – 200 lm
• 2.5 h

LED pen light
1979N-11

EAN-No. 4000896235254

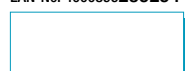

Top light:
• 300 lm
• 4.5 h

Main light:
• 60 – 600 lm
• 3 h

LED solid light
1979N-85

EAN-No. 4000896241491

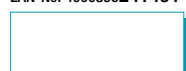

LED slim light
1979N-92

EAN-No. 4000896241415

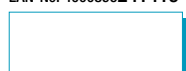

• 200 lm
• 4.5 h

LED torch light
1979N-72

EAN-No. 4000896208487

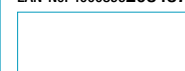

Car body file blades

- Flat
- Milled, diagonal cut
- For file holders 1934 and 1934N-1
- DIN 7264 form A
- Length: 350 mm



- Flat
- Milled, diagonal cut
- For file holders 1934 and 1934N-1
- DIN 7264 form A
- Length: 350 mm



- Half-round (hollow)
- Diagonal cut
- For file holders 1934N-2
- DIN 7264 form F
- Length: 350 mm

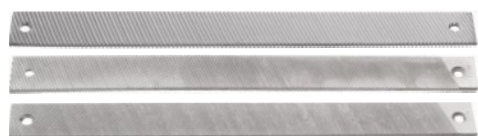

HAZET No.	Teeth (cut):	EAN-No. 4000896 +
1934-1	Coarse	008025
1934-2	Medium	008063
1934-3	Fine	008070

HAZET No.	Teeth (cut):	EAN-No. 4000896 +
1934-4	Coarse	008087
1934-5	Medium	008094

HAZET No.	Teeth (cut):	EAN-No. 4000896 +
1934-7	Coarse	008100

Car body file holders

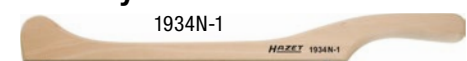

Made in Germany

1934N-1	Car body file holders	008155
1934		008018



Made in Germany



Made in Germany

1934N-2	Car body file holders	008179
---------	-----------------------	--------

Telescopic inspection mirror set



- Mirror interchangeable via 4 mm stainless steel threaded bar with real mirror glass
- Mirror will not tarnish as polished "metal mirrors" do

- **4-piece set:**
 - Telescopic rod: 300–740 mm
 - Round mirror: \varnothing 30 mm and \varnothing 50 mm
 - Rectangular mirror: 65 x 43 mm

1977-2/4
EAN-No. 4000896150144



Dashboard protection set

- With handle



4852/4
EAN-No. 4000896210114



- Straight: 270 x 200 mm, 450 x 300 mm
- Angled: 270 x 200 mm, 450 x 300 mm

Wedge, plastic

- For car body work, e.g. for loosening decorative strips, covers, graphics, etc. without damage
- Tip 0.5 mm
- Dimensions: 190 x 30 x 25 mm



Made in Germany

1965-20
EAN-No. 4000896009183

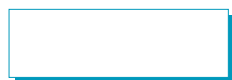

Combination lever

- Quick and easy loosening of the decorative strips and door panels
- Avoids damage to lacquered surfaces, plastic and metal parts
- Operation of plugs and plastic clips
- Removal of protection caps and covers
- Dimensions: 270 x 22 mm



1965-21
EAN-No. 4000896087839



Extractor hook

- For the removal of e.g. trim panels, covers, plugs, fan nozzles, instrument panels, speedometer, instrument clusters inside the vehicle as well as on the car body
- High stability and flexibility despite small blade diameter \varnothing 2 mm

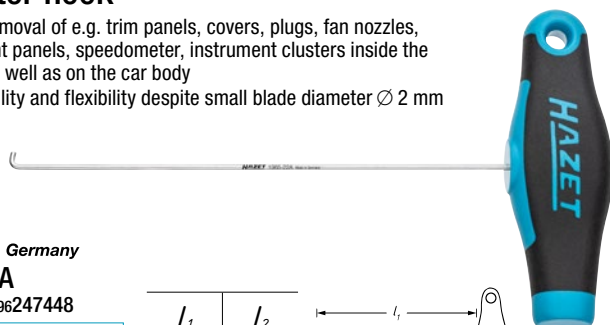

Made in Germany

1965-22A
EAN-No. 4000896247448

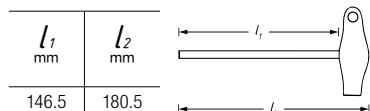

Universal hook/wedge set

- Plastic wedge suitable for loosening components, e.g. door clips as well as for lifting and alignment work
- Universal hook for surface-friendly loosening of e.g. window rubber, door seals, carpets, interior trim
- For universal use
- Plastic wedge: length: 214 mm, width: 26.5 mm
- Universal hook: length: 180 mm



1965/2
EAN-No. 4000896223008



Special tap for exhaust gas temperature sensors / probes

- Professional repair, cleaning or repairing of the mounting threads of the exhaust gas temperature sensors / probes
- Guide bolt prevents jamming of the thread repair tool, thereby enabling exact repair or cleaning of the sooty or damaged thread
- Time saving: replacement of the exhaust system is no longer necessary in most cases
- No tilting or jamming during repair
- 6 cutting surfaces for optimal fitting accuracy as well as easy and quick handling
- High-quality TiAlN coating for longer service life
- Suitable for application on stainless steel components
- Drive: s 13 mm

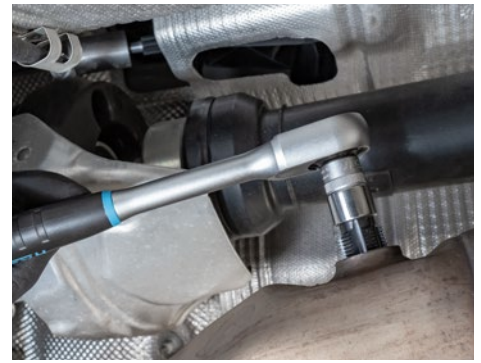

Made in Germany

Thread size: M12 x 1.25

- For exhaust gas temperature sensors on: **NISSAN · RENAULT · BMW · MINI · CITROËN · PEUGEOT · FORD · HYUNDAI · KIA · DACIA · MERCEDES-BENZ · OPEL · VAUXHALL · SUZUKI · IVECO**
- Length: 55 mm

4683-12
EAN-No. 4000896253555



Thread size: M14 x 1.5

- For exhaust gas temperature sensors on: **MERCEDES-BENZ · AUDI · PORSCHE · SEAT · ŠKODA · VW · FIAT · ALFA ROMEO · LANCIA · OPEL**
- Length: 45 mm

4683-14
EAN-No. 4000896253579



Thread size: M16 x 1.5

- For exhaust gas temperature sensors on: **MERCEDES-BENZ Trucks, Bus & DAF commercial vehicles ACTROS · AXOR · ATEGO · MB Bus O 500 BM382 · DAF CF 65 · DAF CF 75 · DAF CF 85 · DAF CF 105**
- Length: 43 mm

4683-16
EAN-No. 4000896253593



Thread size: M18 x 1.5

- For Lambda probes on: **MERCEDES-BENZ · AUDI · PORSCHE · SEAT · ŠKODA · VW · FIAT · ALFA ROMEO · LANCIA · BMW · OPEL · CHEVROLET · DAEWOO · SUZUKI · FORD · HONDA · TOYOTA · NISSAN · Volvo · CITROËN · SAAB · SUBARU · MAZDA · MINI · MITSUBISHI · JAGUAR · ROLLS ROYCE · BENTLEY · LEXUS · PONTIAC**
- Length: 42 mm

4683-18
EAN-No. 4000896253616



Thread size: M20 x 1.5

- For NOX sensors on: **DAF · MERCEDES-BENZ TRUCKS · IVECO · MAN · SCANIA · RENAULT TRUCKS · Volvo TRUCKS**
- Also suitable for passenger car models where a NOX sensor or particle filter sensor with thread M20 x 1.5 is installed. e.g. **BMW · AUDI · VW · OPEL · MERCEDES-BENZ**
- Length: 50 mm

4683-20
EAN-No. 4000896253630



Thread size M22 x 1.5

- For particle sensors on: **AUDI · VW · PORSCHE · OPEL · MERCEDES-BENZ · BMW · GENERAL MOTORS · MAN**
- Length: 50 mm

4683-22
EAN-No. 4000896253654



Exhaust probe sockets

- Removal and installation of the lambda probe, particle sensor, NOX sensor and exhaust gas temperature sensor
- Double square drive 12.5 = 1/2"
- Additional hexagon drive
- Also suitable for closing the slot to avoid widening the opened hexagon
- Torque-controlled tightening possible
- Suitable for all passenger car and commercial vehicle models
- For manual operation
- Surface: phosphatized, oiled
- Dimensions: L 66 x H 39 mm
- Slot width: 8 mm



Robust design for fixed exhaust gas probes!

Made in Germany

HAZET No.	S mm	Double drive 1/2" or	EAN-No. 4000896 +
4680-7	14	Operation with hexagon drive s 24 mm	254118
4680-8	17	Operation with hexagon drive s 24 mm	254132
4680-9	19	Operation with hexagon drive s 24 mm	254156
4680-5	22	Operation with hexagon drive s 30 mm	057870
4680-6	24	Operation with hexagon drive s 30 mm	252268



Tool set for exhaust probes

- 10-piece set:**
- Special taps: 4683-12, 4683-14, 4683-18, 4683-20, 4683-22
 - Exhaust probe sockets: 4680-5, 4680-6, 4680-7, 4680-8, 4680-9

Made in Germany

163-611/10
EAN-No. 4000896257294



4683-16 Optionally available

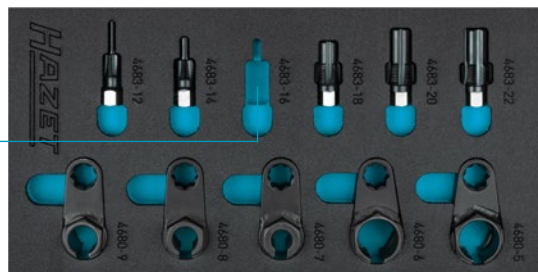

10 **Optionally available: Tool box for safe storage**



HAZET No.	EAN-No. 4000896 +
165-L	167777

Releasing tool for cover of coolant expansion tank, VAG

- Problem-free loosening of very tight lids on the VAG coolant expansion tank
- Exact fit of releasing tool avoids damage to the cover
- For **VW** and Group vehicles as well as electric and hybrid models (MQB platform model year 2013→)
- Manual operation is only possible with great difficulty due to the geometric shape / low overall height of the cover and the recessed seat in the expansion tank

• Diameter: 108 mm



Made in Germany
4803-1
EAN-No. 4000896250158

125 1/2

1/4" screwdriver joint socket XZN

6.3 1/4

- Operation of the fastening screws of the 4/2 way valve with coolant regulator (note: coolant regulator is located inside the coolant pipe and cannot be renewed individually)
- With hinge for use in hard-to-reach places and to bypass interfering edges: fastening screws are located behind the oil filter and cannot be reached in a straight line
- Application e.g. on: 4-cylinder diesel engine (2.0l Common Rail): **AUDI, SEAT, ŠKODA, VW**
- Output: internal serration profile XZN M8



6.3 1/4



Made in Germany
2548G-XZN8
EAN-No. 4000896252701

1/4" Turbo charger special profile socket

- Operation of turbocharger intake manifold (not possible without special tool)
- Special profile engages with a positive fit in the screw connection and guarantees optimal force distribution: **MERCEDES-BENZ, NISSAN, OPEL, RENAULT**
- Surface: phosphatised
- For manual operation



6.3 1/4



Made in Germany
2751-1
EAN-No. 4000896246250

Pipe stopper set

4

- Sealing pipelines in brake systems, air conditioning systems, power steering and fuel systems that cannot be secured with a flexible hose clamp
- Sealing of pipes and preventing the escape of fluids
- Sealing in sizes of 6.3 mm (1/4") · 8 mm (5/16") · 10 mm (3/8") and for double sealing (e.g. banjo connections) in sizes of 10 mm (3/8")



4591/4

EAN-No. 4000896219650

Unlocking tool for VAG plug connections

- Damage-free unlocking of electrical plug connections on various components and sensors
- **VAG** group plug connections, e.g. injectors, rail pressure sensors, fluid level sensors, ignition coils, vacuum sensors, brake wear sensors, pressure regulators and lighting systems
- **SCANIA · MAN TGE / TGX** from model year 2020



• Head offset: 20 mm

Made in Germany

HAZET No.	l mm	EAN-No. 4000896+
4675-1	130	244331
4675-2	191	244348

Extra-long blade, curved at the head allows access to hard-to-reach places!

VAG ignition coil remover

- Fast and safe extraction of the pencil coils
- Removal of pencil coils e.g. on 1.0 l · 1.0 l TSI · TFSI · TGI · GTI · CNG · 1.2 l TSI · 1.4 l · 25 · 30 · 35 · 40 · 45 TSI · TFSI · TGI · CNG · GTE · Mild Hybrid · e-Hybrid · 1.6 l · 1.6 l SRE · MPI · 2.0 l GTI
- Removal of both ignition coil versions possible:
 - 04C.905.110.J → 2017 from **VAG** engines
 - 04E.905.110.K 2017 → from **VAG** engines



Made in Germany

1849-12A

EAN-No. 4000896247387

Engine codes:



Exhaust pipe clamp pliers

- For quick opening and holding open of the reusable exhaust pipe clamps as well as for removal and installation
- The bolt and nut of the exhaust pipe clamp can remain in the clamp during work on the exhaust system thanks to the pliers design
- Application e.g. on: **CITROËN, PEUGEOT · DS · RENAULT · NISSAN, OPEL · ALFA ROMEO · FIAT · JEEP · CADILLAC · LANCIA · SUZUKI, CHEVROLET · BMW · MERCEDES-BENZ · LAND ROVER · FORD · DACIA · NISSAN · Volvo · MAZDA**
- Toothed fixing device and one-hand operation
- Fixing device is released by pressure lever
- Pliers tips enable secure hold of the clamp
- Length: 310 mm
- Clamping range: 50 mm



Made in Germany

4684-3

EAN-No. 4000896189205



Injector sliding hammer, pneumatic

- For removing stuck diesel injectors
- 21 different adapters and a universal claw can be used to gently loosen stuck diesel injectors without much effort. Depending on the injector version, the piezo element must be removed for this purpose
- This prevents damage to the cylinder head/cylinder head cover due to high forces from supports
- In plastic case

24-piece set, contents:

- Pneumatic diesel injector puller
- Extension for deep-seated injectors or installed installation spaces
- Universal claw
- 21 adapter:
 - M17 x P1.0 for **BOSCH** 110,
 - M18 x P 0.75 for **BOSCH** 120, 20 x P 1.0 for **Denso/A**,
 - adapter with inside thread M12 x P 1.5 / outside thread M20 x P 1.5,
 - adapter with inside thread M14 x P 1.5 / outside thread M22 x P 1.5, M14 x P 1.5 for **Delphi**,
 - M16 x P 1.0 for **TOYOTA**,
 - M18 x P 1.5, M8 x P 1.0, M8 x P 1.25, M10 x P 1.0 **Universal adapter**,
 - M14 x P 1.5, M14 x P 1.0, M25 x P 0.5 for **Denso**,
 - M25 x P 1.0 for **SIEMENS**,
 - M27 x P 0.75 for **BOSCH / FIAT / BMW / PSAW / PSA / MERCEDES / RENAULT**,
 - M27 x P 1.0 for complete thread for **SIEMENS**, M29 x P 1.0 for **Delphi**,
 - M31 x P 0.75 for **BOSCH CRIN 1**,
 - M26 x P 0.75 for **BOSCH CRIN 2**

Gentle on materials!

24 NEW!



9098/24
EAN-No. 4000896258086



Cone set, 3 pieces

- **Adaptable set for 2-way air blow gun 9040-4**
- ① For safe cleaning with compressed air for clogged or dirty pipes/hoses thanks to cone attachment up to \varnothing 35 mm
- ② Stuck ignition coil plugs can be pneumatically inflated using the different cones, which leads to the loosening of the stuck area on the spark plug
- Applicable for fuel, air conditioning and AdBlue® lines, hydraulic lines as well as windscreen washer system and coolant
- Removal of rod ignition coils, e.g. on 1.0 l · 1.0 l TSI · TFSI · TGI · GTI · CNG · 1.2 l TSI · 1.4 l · 25 · 30 · 35 · 40 · 45 TSI · TFSI · TGI · CNG · GTE · Mild Hybrid · e-Hybrid 1.6 l · 1.6 l SRE · MPI 2.0 l GTI"
- AUDI** A1 · A3 · A4 · A5 · Q2 · Q3
- CUPRA** Formentor · León
- SEAT** Alhambra · Arona · Ateca · Ibiza · León · Mii · Tarraco · Toledo
- SKODA** Citigo · Fabia · Kamiq · Karoq · Kodiaq · Octavia · Rapid · Scala · Super · Yeti
- VW** Caddy · Golf 6, 7, 8 · Jetta 4 → 7 · CC · Passat B8 / Polo 5 → 6 · Arteon · Beetle · Taigo · Tiguan · Touran · T-Cross · T-Roc · Up! · Scirocco · Sharan · T7
- Coupler thread (outside): 1/8" PF 28

3 NEW!

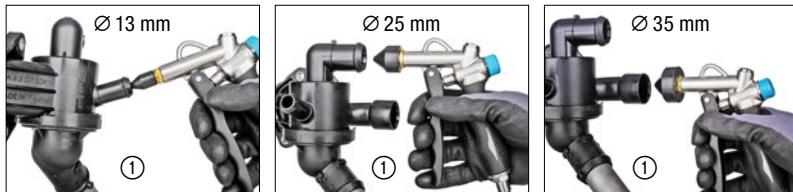
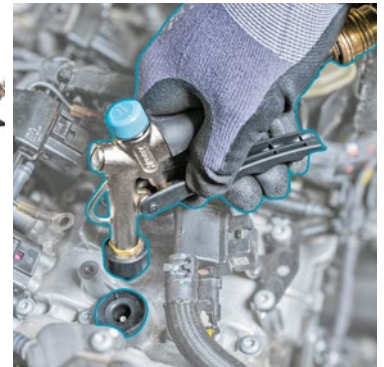
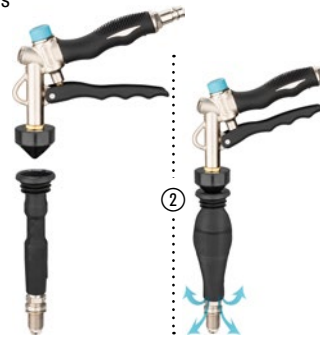

9040-42/3
EAN-No. 4000896254767

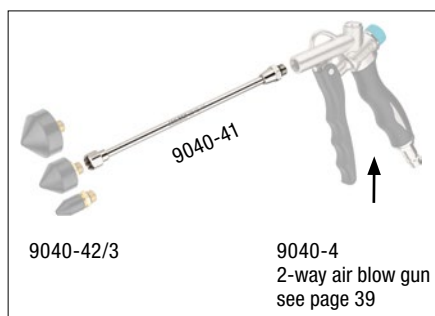

Stainless steel extension

- Low-lying and stuck ignition coil plugs can be released with the cone set
- Coupler thread (inside and outside): 1/8" PF 28
- Length: 187 mm

NEW!



9040-41
EAN-No. 4000896254781

1/2" impact socket, hexagon

- Plastic insert to protect the surface of the wheel bolts
- Length: 85 mm



• Made in Germany
903SLG-17
EAN-No. 4000896045822



• Made in Germany
903SLG-19
EAN-No. 4000896045839



• Made in Germany
903SLG-21
EAN-No. 4000896055135



• Made in Germany
903SLG-22
EAN-No. 4000896155453



- Extra long:
130 mm

• Made in Germany
904SLG-17
EAN-No. 4000896100576



• Made in Germany
904SLG-19
EAN-No. 4000896203710



1/2" sets

3 sockets each in a practical storage box



• Made in Germany
903SLG-17/3
EAN-No. 4000896191697



• Made in Germany
903SLG-19/3
EAN-No. 4000896191734



• Made in Germany
903SPC/3
EAN-No. 4000896128754



Special profile

- Length: 86 mm



• MERCEDES-BENZ
• Made in Germany
905SLG-17
EAN-No. 4000896198795



• KIA & HYUNDAI
• Made in Germany
905SLG-21
EAN-No. 4000896201624



1/2" socket for FORD wheel bolt

- Releasing tool can be used on both sides on **FORD** models
- If the chrome cover is missing or damaged, the wheel nut can no longer be operated with the normal socket
- Solution: two double sockets instead of four single sockets
- Surface: phosphatized, oiled

For use with missing chrome cover



For use on damaged / deformed chrome cover



2-piece set:

- 900SLG-18 x 20 socket
- 917S-3 extension



• Made in Germany
900SLG-18X20/2
EAN-No. 4000896242023

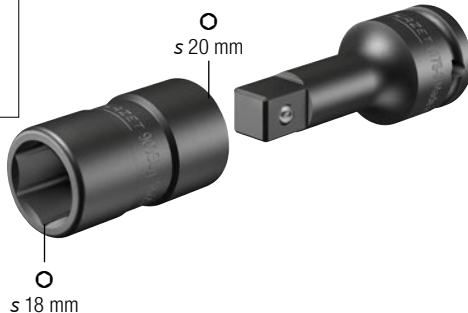

12.5 1/2 2

3-piece set:

- 900SLG-18 x 20 socket
- 900SLG-20 x 22 socket
- 917S-3 extension

• Made in Germany
900SLG-1822/3
EAN-No. 4000896246274



12.5 1/2 3

ONE POWER ADAPTER – MANY POSSIBILITIES!

For all sockets with outside hexagon s 24 mm : 900SZ6 · 990S · 985S



For loosening 1/2" drives with 3/4" power!

Everything fits – for the utmost safety!



3/4" adapter on 1/2"

- Replaceable plug-in blades ● 24 mm – ■ drive 12.5 = 1/2"
- With borehole for locking pin or safety spring and groove for o-ring
- Surface: phosphatized, oiled

Made in Germany
1007S-7/4

EAN-No. 4000896215416



1/2" · 3/4" XZN profile set

- Screw connections on commercial vehicles and passenger cars with XZN profile e.g. on chassis, brake system (brake carriers), engines, shock absorbers and camshaft sprocket
- M14 · M16 · M18
- Short: 43 mm
- Long: 75 mm

Made in Germany
990S/11

EAN-No. 4000896162406



1/2" · 3/4" Impact socket set

- 900SZ6**
s 19 · 21 · 22 · 24 · 27 · 30 · 32 · 36 mm
- 985S**
s 14 · 17 · 19 mm
- 990S**
M14 · M16 · M18
- 985S**
s 14 · 17 · 19 mm
- 990S**
M14 · M16 · M18

Made in Germany
163-570/24

EAN-No. 4000896233441

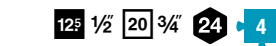

1/2" · 3/4" 12-point traction profile set

- s 19 · 21 · 22 · 24 · 27 · 30 · 32 · 36 mm

Made in Germany
900SZ6/11

EAN-No. 4000896225378



1/2" · 3/4" hexagon profile set

- For screw connections on commercial vehicles and passenger cars, e.g. on chassis, brake system (brake carriers), engines and shock absorbers
- s 14 · 17 · 19 mm
- Short: 45 mm
- Long: 75 mm

Made in Germany
985S/11

EAN-No. 4000896211951



1/2" · 3/4" Impact socket set

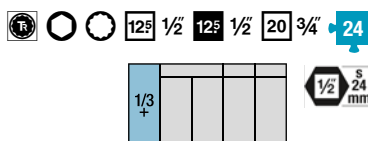

1/2" supplement to 985S/11

- Drive: either 1/2" or 24 mm



Made in Germany
985S-22

EAN-No. 4000896218219



Made in Germany
985S-24

EAN-No. 4000896218226



1/2" socket, hexagon

- Length: 85 mm

Made in Germany
903SLG6-17

EAN-No. 4000896223596



Made in Germany
903SLG6-19

EAN-No. 4000896223589

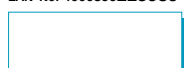

s 17 mm



s 19 mm



Tyre inflators

- Manometer measuring range: 0–12 bar, graduation: 0.1 bar
- Max. pressure: 12 bar
- Temperature range: -20°C to 60°C
- Scale values in bar
- Hose with plug-in nipple
- Measuring tolerance: -15°C to 25°C, 0 – 4 bar: ±0.08 bar, from 4 – 12 bar: ±0.16 bar
- Hose length: 1,000 mm



Calibrated

Recalibration possible
(not carried out by HAZET)

9041G-1

EAN-No. 4000896212385



Ø 80 mm

- Manometer measuring range: 0–12 bar, graduation: 0.01 bar
- Max. pressure: 12 bar
- Temperature range: -20°C to 50°C
- Display toggles between bar / PSI / kg/cm²
- Hose with plug-in nipple
- Measuring tolerance: -15°C to 25°C: ±0.1 bar
- Hose length: 400 mm



Digital

9041D-1

EAN-No. 4000896212378



Ø 63 mm

- Manometer measuring range: 0–12 bar, graduation: 0.1 bar
- Max. pressure: 12 bar
- Temperature range: -10°C to 40°C
- Scale values in psi and bar
- Hose with plug-in nipple
- Measuring tolerance: -15°C to 25°C: ±0.3 bar
- Hose length: 400 mm



Standard

9041-1

EAN-No. 4000896147076



Ø 63 mm

Wheel hub grinder

- With $\frac{1}{2}$ " inside square collet for attachment e.g. to pneumatic, cordless and corded impact wrenches
- For passenger car wheel hubs up to 160 mm Ø
- Internal diameter: 75 mm Ø



1/2"



4960V-160/2

EAN-No. 4000896218394

2-piece set:

- 1 base unit
- 1 grinding wheel
Ø 160 mm

Wheel hub grinder

- 11 mm outside hexagon with 3 contact surfaces for attachment e.g. to pneumatic, cordless and corded drilling machines
- For passenger car wheel hubs up to 160 mm Ø
- Internal diameter: 75 mm Ø

Ø s 11 mm



4960R-160/4

EAN-No. 4000896218820

4-piece set:

- 1 base unit
- 3 grinding wheels
Ø 160 mm

Rim flange cleaner

- 11 mm outside hexagon with 3 contact surfaces for attachment e.g. to pneumatic, cordless and corded drilling machines
- For wheel centring diameter: at least 51 mm
- External diameter up to 160 mm Ø

Ø s 11 mm



4960F-160/2

EAN-No. 4000896218387

2-piece set:

- 1 base unit
- 1 grinding wheel
Ø 160 mm



Brake calliper file

- Blunt scraper on the face side for removing rough residues
- 12 mm wide



Made in Germany

4968-1

EAN-No. 4000896084739



Brake calliper brush

- Removing stubborn brake dust and dirt from the disc brake calliper
- Length: 225 mm



Made in Germany

4968-2

EAN-No. 4000896084821



Brass brake calliper brush

- Cleaning aluminium brake callipers
- Length: 225 mm



Made in Germany

4968-3

EAN-No. 4000896089147



Hook set

- Hook \varnothing 7 mm
- Surface: dip coated
- Length: 190 mm



4968/2H

EAN-No. 4000896221820



Calliper gauge for brake discs / thickness gauge

- Measurement without wheel removal
- Effortless measurement on the vehicle during direct receptions in the presence of the customer
- Also suitable for application on commercial vehicles
- Length: 395 mm



Measuring range:
0 – 60 mm

4956-3

EAN-No. 4000896219032

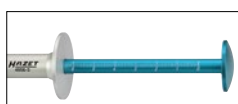

Calliper gauge for brake discs

- Simple, quick determination of the brake disc diameter through wheel opening without removing the wheels
- Length: 450 mm

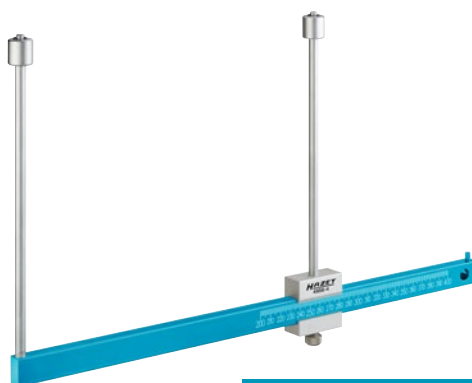

Measuring range:
200 – 400 mm

4956-4

EAN-No. 4000896222339

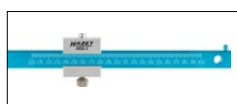

Brake test tool set

- Checking the lateral run-out of the brake disc
- Micrometer screw for exact determination of the thickness of the brake disc
- Precision dial gauge for checking the lateral run-out
- Hinged bracket with magnetic base as mounting and for an exact positioning of the dial gauge on the vehicle



4968/3

EAN-No. 4000896149179



Brake piston readjusting tool set, pneumatic

- Readjusting brake pistons on floating calliper systems with or without locking device for hand brakes
- Universal application thanks to 3-piece adapter set
- Largest possible recovery movement of the piston rod as far as into the housing – operation also when brake piston is extended far
- For smallest brake callipers MINI · BMW 1 Series to BMW X7 (largest brake calliper at present)
- Pneumatic support together with swivelling rotary level allows effortlessly easy and quick resetting

- 2-piece set:
- Basic unit 4970P-1
 - Adapter set 4970P-02/3



4970P-1/4

EAN-No. 4000896232970



For further pressure plates, see the 2024 tool catalogue, from page 447

Brake piston readjusting tool

- For damage-free readjusting brake pistons (floating callipers/fixed callipers) on disc brakes
- For common vehicle types without integrated locking device for handbrakes
- Plate width 50 mm



Made in Germany

4971-1

EAN-No. 4000896156245



Brake adapter plate set

- For brake piston readjusting tool 4971-1 for damage-free resetting of twin piston brake callipers
- Extension of width of supporting surface to 100 x 72 mm
- Easy fixing of the adapter plates using 2 disc magnets: \varnothing 20 mm (holding force per magnet: 2 kg)

Made in Germany

4971-2/2

EAN-No. 4000896246243

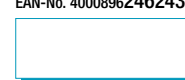



Circlip pliers set

- Correct, centred insertion of the circlip, e.g. when mounting the joint on the drive shaft
- Easy, damage-free assembly of the drive shaft joint: damage to the serration of joint and shaft is avoided with internal circlip during assembly of the drive shaft joint
- Easy fixing of the locking pliers with the circlip
- The pliers automatically slip down when striking the joint
- For drive shafts from all manufacturers
- One-hand operation of the pliers
- No other tools needed



15-piece set:

- Circlip pliers 1847-12
- 7 half shell pairs: Ø: 19 · 21.4 · 22.3–23 · 23.8–24.6 · 26.2–26.9 · 28.5–29.2 · 30 mm

Application tip:

- Insert appropriate half shells (shaft diameter) in pliers
- Place pliers on serration with pre-assembled circlip and clamp
- Pre-positioning of the joint due to conical shape of the pliers makes it easier to introduce the serration without damage.



Half shell pair

- Easy, damage-free installation of the drive shaft joint on VW T5 · T6
- Ø 32.8 mm



Supplement for 1847-12/15



Made in Germany

1847-12/15

EAN-No. 4000896221288



Made in Germany

1847-128/2

EAN-No. 4000896242009



Double cone wheel bearing tool set

- Removal of 3rd generation bolted wheel bearing units in combination with HAZET sliding hammer 1969-17
- Can be used on front and rear axle
- For VAG · FORD · MAZDA · TOYOTA · MITSUBISHI · AUDI A4 · A6 · VW Passat · ŠKODA Octavia · SEAT etc.
- In soft foam insert

11-piece set:

- 1 x spindle total length: 305 mm Outside thread TR20 x 3 Inside thread M20 x 1.5
- 2 x spindle nut TR20 x 3
- 2 x lock nut TR20 x 3
- 6 x cone



Made in Germany

4933-1/11

EAN-No. 4000896223022

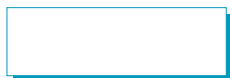

Sliding hammer

- Striking weight: 6 kg
- Coupler thread: M20 x 1.5
- Total length: 890 mm



1969-17

EAN-No. 4000896223015

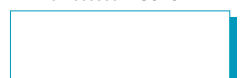

Drive shaft disassembly / assembly set

- Disconnecting the drive shaft joint and pulling in the shaft through the wheel hub with just one tool
- Disconnecting the drive shaft joint from the shaft using the sleeves or spindles together with HAZET sliding hammer 4797-1 (not included in delivery)
- Pulling in the drive shaft through the wheel hub on vehicles where the drive shaft is very difficult to pull through the wheel hub
- Suitable for all vehicle brands
- For drive shafts with outside and inside thread

12-piece set:

- 2 spindles (M14, M16) to pull the drive shaft through the wheel hub or separate the joint from the drive shaft when the joint has an internal thread
- 2 sleeves to support it on the wheel hub
- 1 spindle nut
- 7 screw sleeve adapters:
 - M16 x 1.5 **VAG, MAZDA**
 - M18 x 1.5 **Volvo, SUZUKI, OPEL**
 - M20 x 1.5 **MERCEDES-BENZ, VAG, MITSUBISHI, MAZDA**
 - M22 x 1.5 **FIAT, PSA, BMW, FORD, OPEL, HYUNDAI**
 - M24 x 1.5 **RENAULT, BMW, MERCEDES-BENZ, OPEL, MAZDA, HONDA, VAG**
 - M27 x 1.5 **PSA, BMW, FORD**
 - M30 x 1.5 **MERCEDES-BENZ, PSA, BMW**

12



Made in Germany

4935-11/12

EAN-No. 4000896217434



Impact extractor

- M16 x 1.5
- Striking weight: 1.8 kg
- Surface: galvanised (Cr6-free)
- Length: 460 mm

Made in Germany

4797-1

EAN-No. 4000896121175



Suitable for use with
4935-11/12



* Valid from 1 March 2024 until 28 February 2025. Errors excepted.

Stationary universal spring vice set

Innovative socket and installation concept

- Swivelling in horizontal or vertical working position
- HAZET recommendation for ergonomic working height: adjust vertically, operate horizontally
- Damage to shock absorbers and head plates impossible (no overload risk)
- Simple, lockable strut mount

High safety

- Consistently reliable mounting of head plates
- Thread damage to piston rod impossible
- Permanent fixation of spring throughout operation

Secure investment by using existing components of SYSTEM 4900

- Existing basic units 4900-2 A and all tensioning jaws of System 4900 may be used
- Use of future applications is assured

Allows record keeping by scaling

- If recurring, significant time savings by scaling
- Firm fixation eliminates readjustment at the same spring strut (left/right)

4 pieces, contents:

- Safety spring vice, basic unit 4900-2A
- Base support 4903-1
- Universal clamping disc, adjustable 4903-2
- Universal tensioning jaw, adjustable, including safety adapter 4903-3

Made in Germany

4903/4

EAN-No. 4000896180561

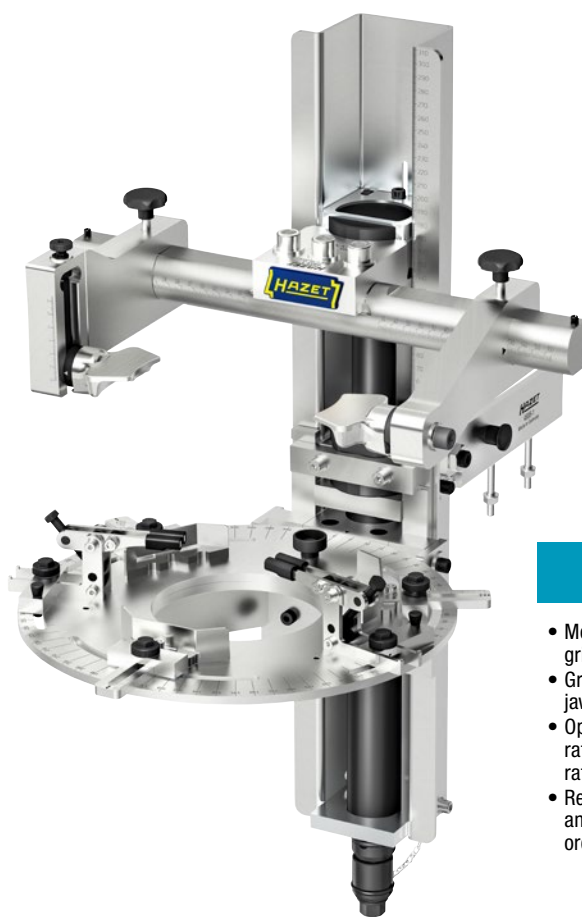

4 steps to success

- Mount strut on clamping disc above gripper and spring-loaded brake
- Grip spring with universal tensioning jaw
- Operate the tensioner with reversible ratchet, cordless screwdriver or air ratchet
- Remove shock absorber load-free and install new one (then reverse order)

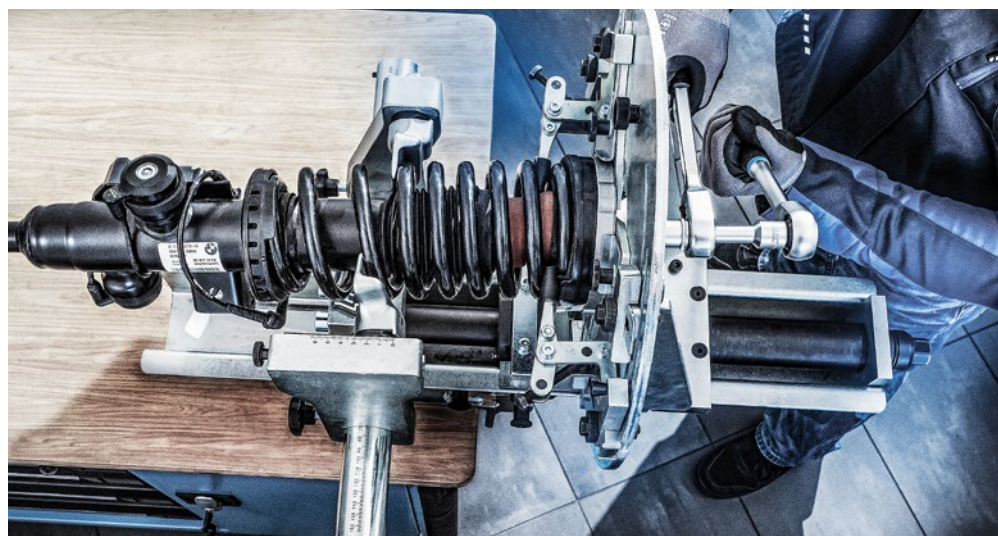

Safety spring vice set

- Installing and removing the coil spring when replacing shock absorbers
- Suitable for impact wrenches
- Suitable for around 100 different vehicle types
- Closed system – maintenance-free
- Variable system thanks to easily replaceable tensioning jaws
- Location bar for machinist's vice
- Maximum span: 309 mm

5 pieces, contents:

- Base support 4900-2A
- 2 tensioning jaws 4900-11
- 2 tensioning jaws 4900-12

Made in Germany

4900-2A/5

EAN-No. 4000896086054

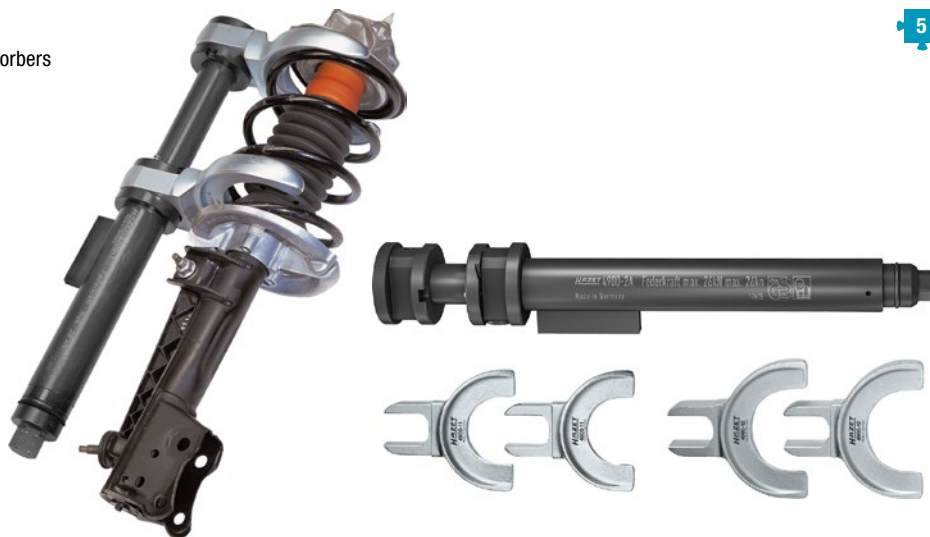

Universal inside spring vice set

- Installation and removal of the coil spring on the rear axle
- Pendulum hexagonal head for equal force distribution with integrated anti-rotation protection for upper tensioning jaws
- One-sided counterholder for the spindle made possible by hexagon on top, e.g. with combination wrench HAZET 600 N-13
- Removal and installation of springs with small coil pitch, e.g. for MINI Cooper S (third generation), VW Passat (B8)
- Extension of the span to 120 mm and an increase of the maximum load for increasing vehicle weights (electric and hybrid vehicles), for safe working up to 31,000 N → Tested with at least four-fold safety against breakage (GS mark of tested safety)
- 17° swivel angle of the tensioning jaws now ensures the removal of C-shaped (bent) springs, e.g. on AUDI A4 (B9), VW Golf 7
- Internal and external guidance of the tensioning jaws prevents the spring from sliding out
- All tensioning jaws included, reusable, replaceable plastic protective pads



Only 202 mm long!



Universal application on almost all passenger cars!

6-piece set, contents:

- 1 inside spring vice 4904-1
- 1 tensioning jaw 4904-10 · span 64 – 115 mm
- 1 tensioning jaw 4904-11 · span 64 – 115 mm
- 1 tensioning jaw 4904-12 · span 79.5 – 133 mm
- 1 tensioning jaw 4904-13 · span 79.5 – 133 mm
- 1 double-ended pipe socket 4902-224 · s 24 mm



Made in Germany

4904/6

EAN-No. 4000896238897



Highlights:

- Easy handling for just one user
- Eliminates time-consuming work associated with most spring removal:
- Removal of axle parts unnecessary
- Axle alignment no longer necessary
- Removal and installation possible in just a few minutes on each side
- Compact design enables spring replacement with remarkable time savings



Support device

- Prevents unwanted raising of the suspension during the spring tensioning process
- Can be used on almost all vehicles – helpful on vehicles with multi-link axle
- Protective pads prevent damage to the vehicle parts
- Facilitates removal of rear axle springs
- Safety: visual chain provides a reminder for tool removal
- Use together with universal inside spring vice set 4904/6
- Clamping range: 80 – 127 mm
- Pressure piece diameter: 30 mm
- Chain length: 750 mm

Supplement to 4904/6

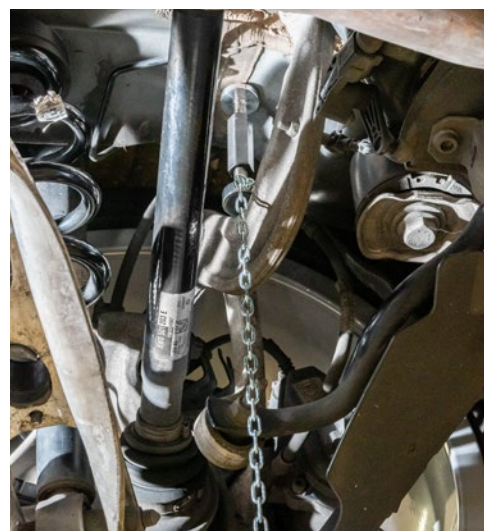

Made in Germany

4912-6

EAN-No. 4000896238835



Universal spreader

- Universal application due to wide spreading range 5 – 11.5 mm
- Expansion of the spring strut and ball joint mounting (separating the spring strut from the wheel bearing housing)
- Optimised end stops with inspection window
- Drive with 1/4" holder for overload protection
- Robust, reinforced design
- Compact design
- For manual operation
- Dimensions: L 60 x H 30 x W 24 mm



Made in Germany

4912-5N

EAN-No. 4000896249312



Large spreading range
5 – 11.5 mm



6.3 1/4"

Inspection window for checking the spreading range from 5 – 11.5 mm



Now with chamfered edge for optimised insertion of the spreader into the steering knuckle!

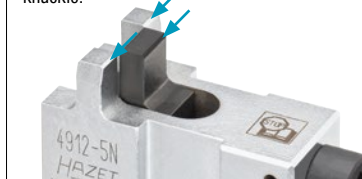

Counterholding with s 17 mm possible



1/2" special screwdriver socket set

- Operation of wheel bearing screw connection in the aluminium housing on **AUDI** and **VW** vehicles as well as **SEAT** and **SKODA**
- Enables loosening of the wheel bearing bolts without removing the drive shaft and ball joint – time saving: approx. 35 min.
- Taper on the shaft allows it to get past the drive shaft joint
- Ideal for confined spaces
- Blade with TiN coating
- 2 lengths available for 4-link axle and McPherson spring struts
- Output: internal serration profile XZN M12
- For manual operation

Made in Germany

2584-12/2

EAN-No. 4000896252640

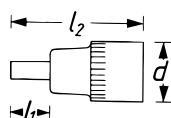

l_1 mm	l_2 mm	d mm
41	74	23

l_1 mm	l_2 mm	d mm
81	114	23

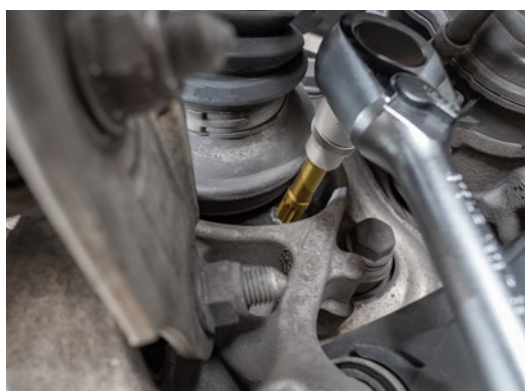

12.9 1/2"

2

TiN

Short design



Long design



3/8" drive shaft screwdriver socket

- Actuation of the stub shaft on **AUDI** and **VW** vehicles as well as **SEAT** and **SKODA**
- Loosening and tightening of the fastening screws on the heat protection plate when removing the drive shaft
- Universal use for deep screw connections
- Can also be used for gearbox repair
- Torque-controlled screw tightening, e.g. with HAZET 5110-3CT possible (Please follow the manufacturer's specifications)
- Extra long design
- Output: inside hexagon profile
- For manual operation

S 6 mm

Made in Germany

2584LG-1A

EAN-No. 4000896252817

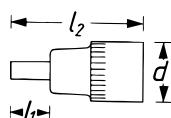

l_1 mm	l_2 mm	d mm
332	359	19



10 3/8"

10 3/8"





Impact bit screwdriver set

23

- Impact operation of tight screw connections
- Up to 80 Nm loosening and tightening torque
- No electricity, compressed air or other resources needed



2272/23N

EAN-No. 4000896192687



Special bumping mallet

- Attaching decorative strips, working on roof rails as well as seat installing, upholstery



1959-2

EAN-No. 4000896102259



- Rubber body 70 x 70 mm



1959-3

EAN-No. 4000896008728



- Rubber body 70 x 140 mm



1959-4

EAN-No. 4000896127221



- Without streaking
- White rubber body 70 x 140 mm

Battery pole and terminal brush

- Cleaning the terminal posts and clamps



4650-4

EAN-No. 4000896022038



Clamp pliers for axle boots

- Installing axle boots made of Hytrel and clamps made of special stainless steel with pre-set torque tightening values together with e.g. torque wrench HAZET 6110-1CT
- For VW, AUDI, SEAT, ŠKODA, OPEL/VAUXHALL, FORD etc.



10 3/8

Made in Germany

HAZET No.	Designation	EAN-No. 4000896 +
1847	Clamp pliers for axle boots	050918
1847/3	Clamp pliers for axle boots 1847 with replaceable jaws 90° (1847-090/2)	206902



Stethoscope



2151

EAN-No. 4000896013043



Hose clamp pliers



- Clamping range: 35 mm
- Length: 206 mm

Made in Germany

798-3

EAN-No. 4000896102433



- Clamping range: 40 mm
- Length: 210 mm

Made in Germany

798-5

EAN-No. 4000896031955



- Clamping range: 27 mm
- Length: 192 mm

Made in Germany

798-13

EAN-No. 4000896155248



- Clamping range: 40 mm
- Length: 210 mm

Made in Germany

798-17

EAN-No. 4000896186068



Cylinder head tightness tester

3

Contents:

- Tester 4793-1
- Reaction fluid (250 ml) 4793-2
- Flushing fluid (250 ml) 4793-3



Made in Germany

4793/3

EAN-No. 4000896076192



Nut splitter, mechanical

- Splitting tight nuts of the quality ranges 5 and 6



Made in Germany

HAZET No.	Size mm	EAN-No. 4000896 +
847-0410A	1 – 17	139903
847-1027A	17 – 24	139910



Assistent®



Over 30% more drawer depth!

163D-10/30

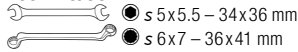

163D-9/42



163D-7/24

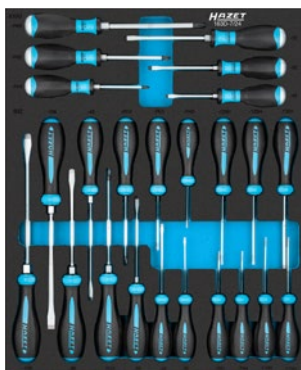

163D-6/53

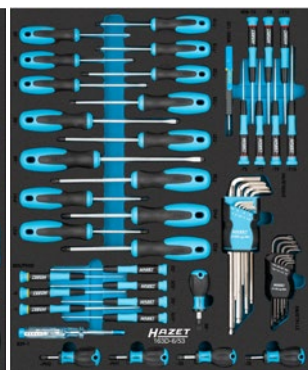

163D-11/11



163D-8/13



179NXXL-8D/619
EAN-No. 4000896245185

619



Das Werkzeug

179NXXL-8D including:

- ▶ 616 expert tools
- ▶ Lateral door
- ▶ Socket strip



163D-1/148



163D-2/103

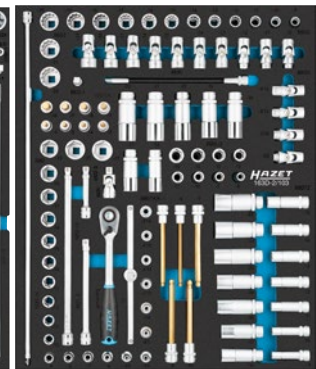

Including

HiPer

6.3 1/4

10 3/8

12.5 1/2

163D-3/94

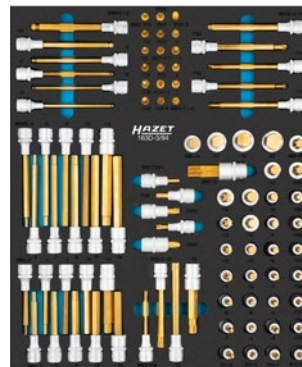

163D-4/44

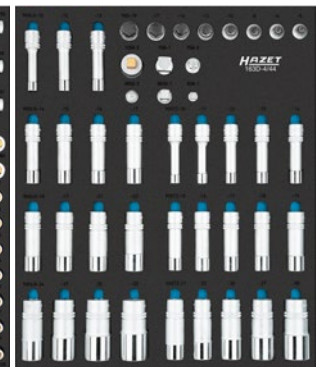

163D-5/24

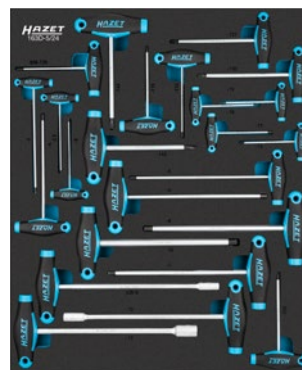

163D-12/30



Your HAZET specialist dealer

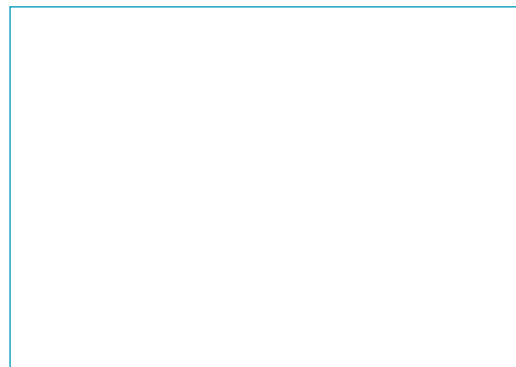

4 000896 260294

SWW24/EN/XX/0 1.02.24/3./JK/MD
Copyright 2024 ©
HAZET-WERK Hermann Zerver GmbH & Co. KG
Güldenwerther Bahnhofstraße 25-29,
D-42857 Remscheid, Germany

Valid from 1 March 2024 until 28 February 2025. Errors excepted. We accept no liability for printing errors! All rights reserved regarding technical modifications and errors. Images may not always correspond to originals and are thus non-binding! © 2024