



GYS

CAR BODY WELDING SYSTEMS 2024B

www.gys.fr

Celebrating

60

years of innovation

1964 - 2024



INVEST IN THE FUTURE



French manufacturer  
since 1964

# Collision Repair

Solutions Réparation Carrosserie

Karosseriereparatur

Attrezzature Riparazione Carrozzerie

Reparación de Carrocería

2024B



SPOT WELDING - DENT PULLER - MIG-MAG/GMAW-FCAW - PLASMA CUTTING -  
INDUCTION - RIVETING - LIFT - BODYSHOP TOOLS

INVEST IN THE FUTURE



## A solid manufacturing group

900 people € 130 000 000

C1+ Credit Rating Banque de France  
55 000 m<sup>2</sup> 2 factories



INVEST IN THE FUTURE



French manufacturer since 1964

## A family company



Nicolas & Bruno Bouygues



Welding, Plasma cutting & Induction heating



Collision repair



Chargers, Boosters & Starters

## A worldwide coverage

125 countries



GYS FRANCE Laval

GYS GERMANY Aachen

GYS U.K. Rugby

GYS CHINA Shanghai

GYS ITALIA Venezia

GYS IBERICA Madrid

[www.gys.fr](http://www.gys.fr)



visit with



## DENT PULLING

GYS POT	6
GYS POT PRO	7
GYS POT ALU	8
GYS POT COMBI	9
ACCESSORIES & CONSUMABLES	10
GYS POT ARCPULL	12
COMBI ARCPULL	13
ACCESSORIES & CONSUMABLES	16
FAST EASY TOOLS	18
ACCESSORIES LEVELLING BARS	20
COMPLETE WORKSTATIONS	24

## PULLING SYSTEMS

AIRFIX DRAW ALIGNER	38
DRAW ALIGNER	40
FRAME STRAIGHTENING	42

## PAINTLESS DENT REPAIR

POWERDUCTION AUTO DENT REPAIR	46
GLUE PULLING REPAIR	50

## SPOT WELDING

TECHNOLOGY	54
PORTASPOT / GYS POT 32D-X / 100R-CX	56
GYS POT BP GENIUS	58
GYS POT PTI-S7 / PTI PREMIUM PRO	60
GYS POT PTI GENIUS	62
GYS POT PTI NEO	64
GYS POT PTI MASTER / PTI EXPERT	66
G ARMS	68
ACCESSORIES & CONSUMABLES	69
X ARMS / C ARMS	70

## RIVETING

GYS PRESS 10T	73
GYS PRESS PREMIUM 10T PP	75
WORKSTATION	76
ADAPTERS	78
DIES BOXES & RIVETS	80
ACCESSORIES	83

## MIG WELDING

GYS AUTO	86
E GYS AUTO	88
P GYS AUTO	90
AUTOPULSE	92
TORCHES & CONSUMABLES	96

## PLASMA

EASYCUT K	101
EASYCUT	102
CUTTER	103

## INDUCTION HEATING

GYS DUCTION	106
COMBI DUCTION	107
POWER DUCTION	108
ACCESSORIES & CONSUMABLES	112

## TRUCK TOOLS & MOBILE LIFTS

TROLLEY IW1	115
MULTITOOL TRUCK	115
SPOT LIFT	116
QUICKLIFT / AIR JACKS	118
ERGO LIFT	119
MANUAL DOOR LIFT / MANUAL WHEEL LIFT	120

## ACCESSORIES

WELDING HELMETS	122
FUME EXTRACTION	125
WINDSCREEN REPAIR	123
BUMPER REPAIR	128
HAND TOOLS	130
PNEUMATIC TOOLS	134
WORKING LIGHTS	136
SANDING & DUST EXTRACTION	138
WORKING SUPPORTS	140
ELECTRIC VEHICLES	144
SAFETY PROTECTION	146





# DENT PULLING

## STEEL / ACIER / STAHL

GYSPOT	6
GYSPOT PRO	7

## ALU

GYSPOT ALU	8
------------	---

## ALU + STEEL / ACIER / STAHL

GYSPOT COMBI	9
ACCESSORIES & CONSUMABLES	10

## DRAWN ARC ALU + STEEL / ACIER / STAHL

GYSPOT ARCPULL	12
COMBI ARCPULL	13
ACCESSORIES & CONSUMABLES	16

FAST DENT PULLING	18
-------------------	----

LEVELLING BARS	20
----------------	----

COMPLETE WORKSTATIONS	24
-----------------------	----





GYSPOT

# DENT PULLING STEEL ACIER - STAHL

- Stars - Étoiles - Ausbeulstern
- Rings - Anneaux - Zugösen
- Wavy wires - Fils ondulés - Wellendraht
- Impact shrinking - Rabattage d'impact - Glätten

## OPTIONS

Consommables - Consumables p.10



Chariots - Trolleys p.24



- Stars - Étoiles - Ausbeulstern
- Rings - Anneaux - Zugösen
- Wavy wires - Fils ondulés - Wellendraht
- Impact shrinking - Rabattage d'impact - Glätten
- Tempering - Rétreinte - Temperieren



**FIXED GUN**

**FIXED GUN**

GYSPOT 26.02

**2600 A** x1 **AUTOMATIC**

230V • 1~

052208

included

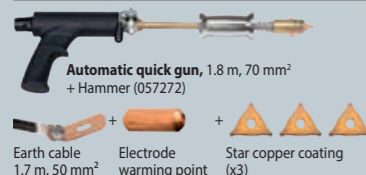

Earth cable 1.7 m, 50 mm<sup>2</sup> | Electrode warming point | Star copper coating (x3)

GYSPOT 27.02

**2600 A** x1 **MANUAL**

230V • 1~

055353

included

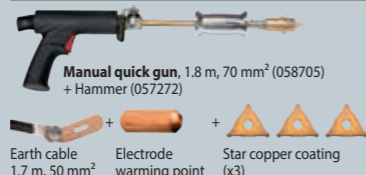

Earth cable 1.7 m, 50 mm<sup>2</sup> | Electrode warming point | Star copper coating (x3)

GYSPOT 34.02 & 34.04

**3500 A** x1 **MANUAL**

230V • 1~

GYSPOT 34.02  
065741

400V • 2~

GYSPOT 34.04  
067943

included

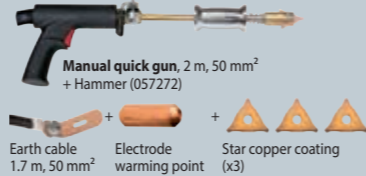

Earth cable 1.7 m, 50 mm<sup>2</sup> | Electrode warming point | Star copper coating (x3)

- Stars - Étoiles - Ausbeulstern
- Rings - Anneaux - Zugösen
- Wavy wires - Fils ondulés - Wellendraht
- Impact shrinking - Rabattage d'impact - Glätten
- Tempering - Rétreinte - Temperieren
- Rivets - Rivets - Nieten
- Rings - Rondelles - Unterlegscheiben
- Studs - Goujons - Gewindebolzen

SYNERGIC CONTROL

PATENTS REGISTERED NUMBERS EUROPEAN TRADEMARK & DESIGN



**GUN WITH CONNECTOR**

GYSPOT 39.02 & 39.04

**3800 A** x1 **AUTOMATIC**

230V • 1~

GYSPOT 39.02  
052215

400V • 2~

GYSPOT 39.04  
052222

included

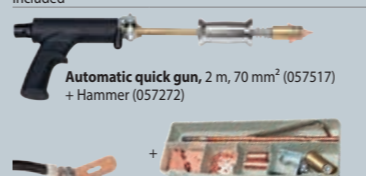

Earth cable 2 m, 70 mm<sup>2</sup> | SPOTTER BOX STANDARD (053915) (Details p.10)

GYSPOT PRO 230 & PRO 400

**3800 A** x2 **AUTOMATIC**

230V • 1~

GYSPOT PRO 230  
052178

400V • 2~

GYSPOT PRO 400  
052185

included

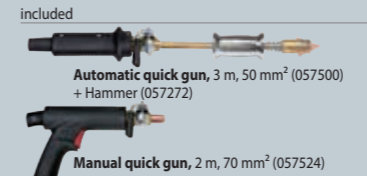

Earth cable 2 m, 70 mm<sup>2</sup> | SPOTTER BOX PRO (050075) (Details p.10)

GYSPOT EXPERT 200, 230 & 400

**3800-4500 A** x2 **AUTOMATIC**

230V • 1~

GYSPOT EXPERT 230  
066885

200-240V • 1~

GYSPOT EXPERT 200  
058842

4350 > 5100 A

GYSPOT EXPERT 400  
058859

included

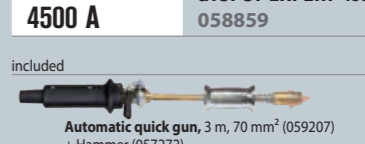

Earth cable Thick 3 mm 2 m, 70 mm<sup>2</sup> | SPOTTER BOX PRO (050075) (Details p.10)

QUICK GUNS

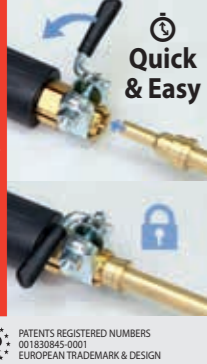

**AUTOMATIC**



**WITH CONNECTOR**  
2 m, Ø 70 mm<sup>2</sup>  
included 39.02/04  
057517



**WITH CONNECTOR**  
3 m, Ø 50 mm<sup>2</sup>  
included PRO 230/400  
057500

**WITH CONNECTOR**  
3 m, Ø 70 mm<sup>2</sup>  
included EXPERT 200/230/400  
059207

**MANUAL**



**WITH CONNECTOR**  
cable 2 m, Ø 70 mm<sup>2</sup>  
included PRO 230/400,  
EXPERT 200/230/400,  
COMBI 230EPRO  
057524

**No connector**  
cable 1.8 m, Ø 70 mm<sup>2</sup>  
for 27.02  
058705

**No connector**  
cable 2 m, Ø 50 mm<sup>2</sup>  
for 34.02/34.04

Mandrels for gun - Mandrins pour pistolets - Pistole & Anschlußstücke, Zubehör



QUICK GUN 057531



D1 048959



Nut - Écrou 053199

Microswitch 053267

	G NORM 62135	50/60 Hz	I <sub>2</sub> max	U <sub>2</sub>	I <sub>AM</sub>	I <sub>RMS</sub>	kW	OK	OK	MANUAL	SYNERGIC	AUTOMATIC	MANUAL	SEPARATE CABLE GUN	LxWxH cm / kg
GYSPOT 26.02	230V	2 m	2600	5,4	16	1800	10	OK	—	—	—	—	—	—	40 x 25 x 31 / 18
GYSPOT 27.02	230V	2 m	2600	5,4	16	1800	10	OK	—	—	—	—	—	—	40 x 25 x 31 / 18
GYSPOT 34.02	230V	2 m	3500	7,4	16	2500	20	OK	OK	—	—	—	—	—	42 x 36 x 31 / 23.9
GYSPOT 34.04	400V, 2ph	4 m	3500	7,4	16	2500	20	OK	OK	—	—	—	—	—	42 x 36 x 31 / 24
GYSPOT 39.02	230V	4 m	3800	7,4	16	2800	20	OK	OK	—	—	—	—	—	49 x 38 x 29 / 27.5
GYSPOT 39.04	400V, 2ph	4 m	3800	7,4	16	2800	20	OK	OK	—	—	—	—	—	49 x 38 x 29 / 25.2
GYSPOT PRO 230	230V	8 m	3800	7,4	16	2800	20	OK	OK	—	—	—	—	—	49 x 38 x 29 / 29.6
GYSPOT PRO 400	400V, 2ph	8 m	3800	7,4	16	2800	20	OK	OK	—	—	—	—	—	49 x 38 x 29 / 29.4
GYSPOT EXPERT 200	200-240V	8 m	4350 > 5100	7,2-8,7	30(D)	3100 > 3600	25 > 36	OK	OK	—	—	—	—	—	49 x 38 x 29 / 34.6
GYSPOT EXPERT 230	230V	8 m	3800	7,4	16	2800	20	OK	OK	—	—	—	—	—	49 x 37 x 31 / 30.6
GYSPOT EXPERT 400	400V, 2ph	8 m	4500	7,4	16(D)	3200	25	OK	OK	—	—	—	—	—	49 x 38 x 29 / 32.9

GYSPOT

STEEL DENT PULLING





GYS POT ALU

# DENT PULLING ALU



SYNERGIC CONTROL

PATENTS REGISTERED NUMBERS EUROPEAN TRADEMARK & DESIGN



Goujons - Studs

NEW



FIXED GUN

GYS POT ALU 66

13000 A x1 AUTOMATIC

230V • 1~ AD

080188

included for Ø 4 mm



AD ANTI-DUST



GYS POT ALU PRO FV

13000 A x1 AUTOMATIC

110 > 230V • 1~ FV

021990

included for Ø 4 mm



FV FLEXIBLE VOLTAGE

85 V ← 265 V

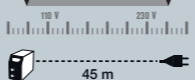

ALU GUN

AUTOMATIC

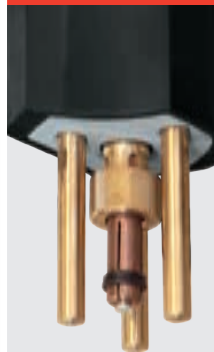

3 m, Ø 25 mm<sup>2</sup>

included SPOT ALU FV & COMBISLOT 230

054066

(x 3) 065635

66 mF CAPACITOR DISCHARGE WELDING

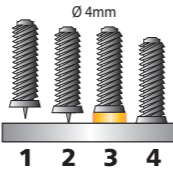

Joint rings for mandrel Ø 4/5/6 x 2 060814

PATENTS REGISTERED NUMBERS EUROPEAN TRADEMARK & DESIGN

with connectors for COMBISLOT 230

OPTIONS

Consumables - Consommables p.11



ALU accessories - Accessoires ALU p.19



Trolleys - Chariots p.24



GYS POT COMBI

# DENT PULLING ALU+STEEL ACIER - STAHL

PATENTS REGISTERED NUMBERS EUROPEAN TRADEMARK & DESIGN

Steel / Acier / Stahl

Alu



- Stars - Étoiles
- Rings - Anneaux
- Wavy wires - Fils ondulés
- Impact shrinking - Rabattage d'impact
- Tempering - Rétreinte
- Rivets - Rivets
- Rings - Rondelles
- Studs - Goujons

2 GUNS INCLUDED



GUN WITH CONNECTOR

GYS POT COMBI 230 E.PRO

3800 A Acier / Steel / Stahl

13000 A Alu

230V • 1~

AUTOMATIC MANUAL x2 AUTOMATIC

021266

included



Manual quick gun, 2 m, 70 mm<sup>2</sup> (057524) + Hammer (057272)

Automatic alu gun, 3 m, 25 mm<sup>2</sup>



Earth cable 2 m, 70 mm<sup>2</sup>

SPOTTER BOX PRO (050075) (Details p.10)

ALU BOX STANDARD (050020) (Details p.11)

				$I_2$ max	$U_2$	$I_{RMS}$	kW			MANUAL	SYNERGIC			AUTOMATIC	MANUAL	SEPARATE CABLE GUN			LxWxH cm / kg
MADE IN GYS CHINA	62135	50/60 Hz		A	V	A	A	OK	OK	MANUAL	■	■	■	x1	—	—	3 m	Included Alu box	27 x 20.5 x 27 / 13.5
MADE IN FRANCE	GYS POT ALU PRO FV	110 > 230V	6 m	13 000	50 > 200	5	—	0.65	OK	OK	■	■	■	x1	—	—	3 m	Included Alu box	49 x 38 x 29 / 13.4
	GYS POT COMBI 230 E.PRO	230V	8 m	3800 (steel) 13000 (alu)	7,4 (steel) 50 > 200 (alu)	16	2800 (steel)	20	OK	OK	—	■	■	x1	x1	■	2/3 m	Included Spotter box + Alu box	54 x 76 x 34 / 47.5

GYS POT

ALU + STEEL DENT PULLING





## STEEL / ACIER / STAHL



**DENT BOX**  
CONSUMABLES / BAR / EASY



**SPOTTER BOX**  
STANDARD / 2600 / 2700

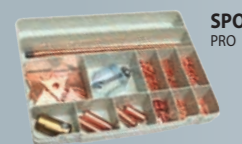

**SPOTTER BOX**  
PRO

		x1	x20	x1	x100	x1	x5	x1	x1	x100	x1	x50	x1	x1	x100	x50	x3 180, 300, 500 mm	x1	x100	x100	x100	x1	x100	x100	x1	x100	x1	x1	x1	x1	x1
		049482	052239	049574	049444	056718	049468	049567	059726	050303	049789	049727	049772	050655	050648	050631	050792	049598	049383	049420	049413	049604	049345	049352	049277	041561	050310	049673	052529	049666	051997

### DENT BOX

<b>CONSUMABLES</b> 051515	x20										x25			x50	x25																	
<b>BAR</b> 050037											x1	x25		x1	x50		x1	180mm														
<b>EASY</b> 053632														x1	x50		x1	180mm														

### SPOTTER BOX

<b>PRO</b> 050075	included PRO, EXPERT & COMBI 230	x1	x1	x1	x20	x1	x50	x1	x1	x1																								
<b>STANDARD</b> 053915		x1	x1	x1	x20	x1	x50	x1	x1	x1																								
<b>2600</b> 052277	ideal GYSPOT 2600				x20	x1	x50	x1																										
<b>2700</b> 053922	ideal GYSPOT 2700				x20	x1	x50	x1	x1																									

BEST SELLER

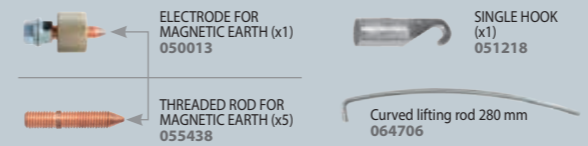

## SLIDE HAMMERS - Marteaux inertie - Ausbeulhammer

**COMPLETE**  
057272

1.1 kg

Options:

- (x1) 054028
- (x5) 050839

included (x1) 049482

included (x20) 052239

**COMPLETE KIT**  
051225

2.5 kg

- (x1)
- (x25)
- (x50)
- (x1)
- (x1)



Nails - Clous - Nägel  
041813

1.1 kg

- Ø 2, M4 (x1) 049277
- Ø 2 (x100) 041561
- MIG/MAG nozzle for Nail welding 041523

Washers - Rondelles - Ringe  
051201

1.7 kg

- Ø 16, 8x16 (x1) 049574
- 8x16 (x100) 049444
- (x1) 051218

51 cm

Slide hammer kit - Kit marteau à inertie - Ausbeulhammerset  
051928

6 kg

## ALU

Joint rings for mandrel Ø 4/5/6  
x2  
060814

mandrel for ALU GUN	alu magnesium screws 12 mm	alu silicium screws 12 mm	screwable rings ø4 x5	fast pulling rings x5	lifting rod x3: 180, 300, 500 mm
ø 4 x2 049000	ø 5 x1 048157	ø 6 x1 048164	ø 4 - M4 x200 050273	ø 4 - M4 x1000 050129	ø 5 x100 048140
ø 5 x1 048157	ø 6 x1 048164	ø 6 x1 048133	ø 4 - M4 x200 050280	ø 4 - M4 x1000 050136	ø 5 x100 048126
ø 6 x1 048164	ø 6 x1 048133	ø 6 x1 048133	ø 5 x100 048126	ø 6 x100 048003	ø 6 x100 048003

**ALU BOX**

<b>LIGHT Ø 4</b> 051522			ø 4	ø 4	
			x200	x200	
<b>STANDARD Ø 4</b> 050020			ø 4	ø 4	
			x200	x200	
<b>Ø 5 &amp; 6</b> 048195					
			ø 5 x100	ø 5 x100	
			+ ø 6 x100	+ ø 6 x100	





# DENT PULLING DRAWN ARC ALU + STEEL

ACIER - STAHL



MANUAL



- 1 Start-up - Amorce - Zündung
- 2 Scouring (I & t) - Décapage - Abbeizen
- 3 Arc (I & t) - Arc - Lichtbogen
- 4 Hitching (I & t) - Accroche - Verklebung
- 5 Height - Hauteur - Höhe

- Rings - Anneaux - Zugösen
- Studs - Goujons - Gewindebolzen
- Stainless steel nails - Tiges inox - Edelstahlnägel



7 languages  
FR, EN, DE, SP, IT, NL & RU

## SYNERGIC DIGITAL GUNS

★★★★★  
**UNIQUE Linear Motor**

**DRAWN ARC PROCESS**  
Gas protection

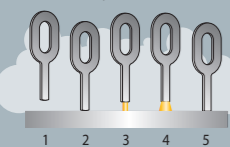

3 m, Ø 25 mm<sup>2</sup>  
included  
ARCPULL  
200 & 350,  
COMBI ARCPULL



Full control



Consumables for Gun



FV FLEXIBLE VOLTAGE

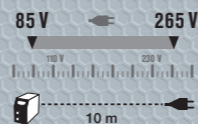

SR SECONDARY REGULATION



AD ANTI-DUST

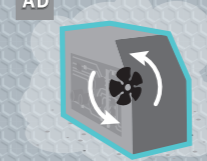

MANUAL & SYNERGIC CONTROL

2 GUNS INCLUDED



Ø max  
Alu : 6 mm  
Fe : 6 mm



GUN WITH CONNECTOR

### GYSPOT ARCPULL 200 CAR BODY REPAIR

100 · 230V · 1~  
**200 A** **T x1 MANUAL**  
FV SR AD  
057470  
included



### OPTIONS



### GYSPOT COMBI ARCPULL

230V · 1~	
<b>ARCPULL 200 A</b> Alu	<b>EXPERT 3800 A</b> Acier / Steel / Stahl
<b>T x1</b> MANUAL	<b>T x1</b> MANUAL

### OPTION : AUTOMATIC



MADE IN FRANCE 60974-1	50/60 Hz	I <sub>2</sub> A	SYNERGIC	MANUAL	IRMS (A)	GUN		U <sub>2</sub> V	A	kW	OK	OK	LxWxH cm / kg
						Acier/Steel	Alu						
<b>GYSPOT ARCPULL 200 CAR BODY REPAIR</b>	110 · 230V	6 m	10 · 100 (110 V) 10 · 200 (230 V)	■	■	—	Manual + Digital Gun Motion Control	20.4 · 24 V (110 V) 20.4 · 28 V (230 V)	16	2.4 (110 V) 5.6 (230 V)	OK	OK	49 x 37 x 30 / 14.5
<b>GYSPOT COMBI ARCPULL</b>	230V	8 m	Alu 10 · 200 Acier 3800	■	■	Steel 3800	Manual Automatic (not included)	Alu 20.4 · 28 V Steel 7.4 V	16	Alu 5.6 Steel 20	OK	OK	72 x 42 x 29 / 41.5





GYS POT ARCPULL

# DENT PULLING DRAWN ARC ALU + STEEL ACIER - STAHL

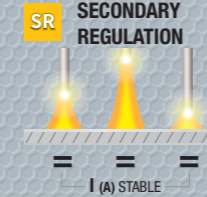
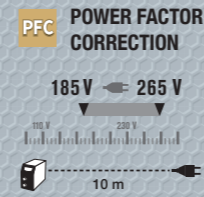

- Rings - Anneaux - Zugösen
- Start-up - Amorce - Zündung
- Hitching (I & t)
- Studs - Goujons - Gewindebolzen
- Scouring (I & t) - Décapage
- Accroche - Verklebung
- Stainless steel nails - Tiges inox
- Abbeizen
- Height - Hauteur
- Edelstahlnägel
- Arc (I & t) - Arc - Lichtbogen
- Hohe



**7 languages**  
FR, EN, DE, SP, IT, NL & RU



∅ max  
Alu/Fe: **8 mm**



∅ max  
Alu: **10 mm**  
Fe: **13 mm**



## SYNERGIC DIGITAL GUNS

★★★★★ **DRAWN ARC PROCESS**  
Gas protection

**UNIQUE Linear Motor**

3 m, ∅ 25 mm<sup>2</sup>

included  
ARCPULL 200, 350 & COMBI ARCPULL

Adjustable

**FULL CONTROL**

Consumables for Gun

- x2 059627
- x1 059610

### GYS POT ARCPULL 350 CAR BODY REPAIR

208 · 240V · 1~

**350 A** x1 MANUAL

PFC SR AD

082953

included

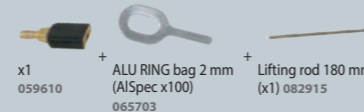

#### OPTIONS

details p.24

Weld 810 for ARCPULL 350 037489



### GYS POT ARCPULL 700 CAR BODY REPAIR

380 · 480V · 3~

**680 A** x1 MANUAL

SR IP 23

#### OPTIONS

details p.24

Weld 910 for ARCPULL 700 070967



#### 068315

included



MADE IN FRANCE 60974-1	50/60 Hz	I <sub>2</sub> A	SYNERGIC	TECHNOLOGY		U <sub>2</sub> V	A	kW	OK	OK	LxWxH cm / kg
				Acier/Steel	Alu						
GYS POT ARCPULL 350 CAR BODY REPAIR	208 · 240V	6 m	10 · 350	Manual + Digital Gun Motion Control	Power Factor Correction	20.4 · 34V	16	11.9	OK	OK	48 x 36 x 30 / 17.4
GYS POT ARCPULL 700 CAR BODY REPAIR	3x 400V 3x 480V	5 m	50 · 680	Manual + Digital Gun Motion Control	—	22 · 44V	20 A (D) 16 A (D)	47.8 kW 45.7 kW	OK	OK	60 x 43 x 46 / 27.8







# GYSPOT ARC PULL 200, 350 & COMBI ACCESSORIES & CONSUMABLES

## ACIER / STEEL / STAHL

x1 059443	x1 059634	x1 059641	x1 064065	x100 041561	x100 064034	x2 049000	x100 059603	x100 064607	x1 048157	x100 049383	x100 049413	x100 049420	x1 048164	x100 063969	x200 063990	x1 064041	x200 064003	x1 064058	x100 063976
<b>STEEL STUDS BOX 200 &amp; 350</b> 059443	x1	x1				x1	x100		x1	x100	x100	x100							x1

## ALU

x1 059634	x1 059641	x2 049000	x100 059573	x1 048157	x100 059580	x1 048164	x100 059597	x200 064010	x1 064041	x200 064027	x1 064058	x100 063983	
<b>ALU STUDS BOX 200 &amp; 350</b> 059436	x1	x1	x1	x100	x1	x100	x1	x100	x1	x100	x1	x100	

	straight rings						twisted rings							
	Al-Special		AlMg3		AlMgSi		Al-Special		AlMg3 - x 50		AlMgSi - x 50			
box	n°1 1mm x100	n°4 1.5mm x100	n°8 2mm x100	n°2 1mm x100	n°5 1.5mm x100	n°3 1mm x100	n°6 1.5mm x100	n°1 1mm x50	n°4 1.5mm x50	n°2 1mm x50	n°5 1.5mm x50	n°3 1mm x50	n°6 1.5mm x50	
	059535	059559	065703	059498	059511	059450	059474	059542	059566	059504	059528	059467	059481	
box	<b>ALU RING BOX 1 mm</b> 059412		1mm x50		1mm x50		1mm x50		1mm x20		1mm x20		1mm x20	
box	<b>ALU RING BOX 1.5 mm</b> 059429		1.5mm x50		1.5mm x50		1.5mm x50		1.5mm x20		1.5mm x20		1.5mm x20	
sachet - bag	<b>ALU RING BOX 2 mm</b> 065703		2mm x100											

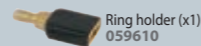

Earth clamp  
Croco T400.70  
043787



Double earth clamp  
25 mm², 3 m, 350 A  
070714

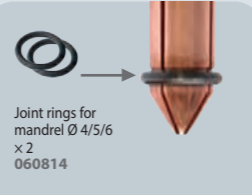

Joint rings for  
mandrel Ø4/5/6  
x2  
060814

x1 064591	x1 070813	x1 059634	x1 059641	Ø2mm x1 064065	Ø4mm x2 049000	Ø5mm x1 048157	Ø6mm x1 048164	Ø7.1mm x1 064041	Ø8mm x1 064058	x1 070806	x1 070790	M4 x1 070752	M5 x1 070769	M6 x1 070776	M8 x1 070783	x1 070714	
<b>STUDS HOLDER BOX 350</b> 064591	x1	x1	x1	x1	x1	x1	x1	x1	x1								x1
<b>ARCPULL DIFFICULT ACCESS BOX 350</b> 070813	x1	x1								x1	x1	x1	x1	x1	x1	x1	x1

Difficult access :

To be used with :

x100 064607		x1 059634	x1 059641	x2 049000	x1 064683	x1 067721	x1 070738	x100 070745	x1 066151	
<b>ARCPULL RIVET BOX 1 350 - 24kN</b> 064584	x100	x1	x1	x1	x1	x1	x1			
<b>ARCPULL RIVET BOX 2 350 - 50 kN</b> 073388			x1	x1				x1	x100	x1



## GYSPOT ARC PULL 700 - ACCESSORIES & CONSUMABLES

x100 070745	x1 070738	x1 066151	x1 071377	x1 059641	x2 059610	x1 071384	x1	Ø6 x1 075368	Ø8 x1 075375	Ø10 x1 075382	Ø5 x1 076174	Ø6 x1 068391	Ø8 x1 068407
<b>ARCPULL RIVET BOX 700</b> 068452	x100	x1		x1	x1	x2	x1	x1	x1	x1			





# FAST DENT PULLING

## STEEL / ACIER / STAHL

### EASY TOOL CONNECTION



for GYSPOT 39.02/04, PRO 230/400, EXPERT 230/400, COMBISPOT 230



051690

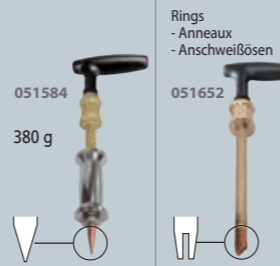

051584  
380 g

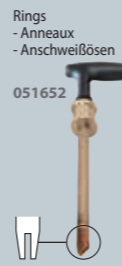

051652

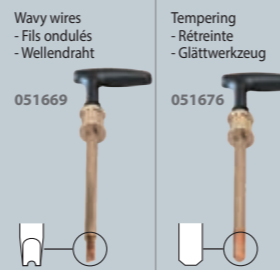

051669



051676



Manual dent-pulling bar - Poignée de tirage manuel 057289



EASYGUN 051317



Box of 3 electrodes for accessories 050822

### MANUSPOT = 050679



Tools set and support for DENT 600, 800, 1000, 1600, Workstation & Dentstation



EASYGUN 051317



MANULINER 050471

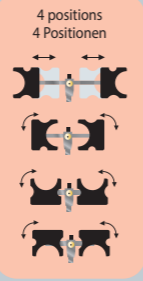

4 positions 4 Positionen

### FAST & EASY



RINGMATIC 052154

included (x 50)



Option Gun adapter - Adaptateur pistolet 052499

### MANULINER/GUN 056831

PATENTS REGISTERED NUMBERS 001652108-0003 EUROPEAN TRADEMARK & DESIGN



Pads - Patins (x2) 060807



Gun adapter - Adaptateur pistolet included 052499

### DENT AXE PULLER 080508



Direct impact electrodes (x5) 050839

### QUICK SPOT AIR GUN V2 057340



LIGHT 920 g

AIR

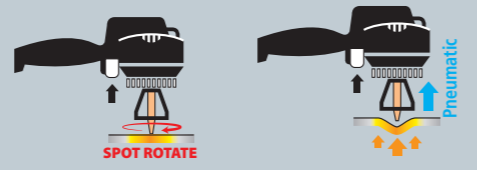

SPOT ROTATE

Pneumatic



Gun adapter - Adaptateur pistolet 052826

### MANU PULLER 079502



Included Alu 3 065178  
Included Steel 079830  
Included Alu 4 065185

## ALU

### ARC PULLER PREMIUM 065161

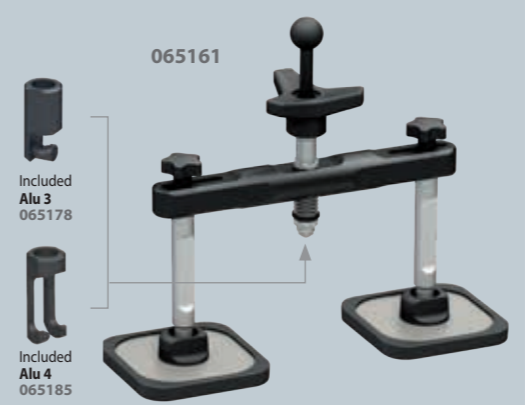

Included Alu 3 065178  
Included Alu 4 065185



### ARC PULLER PREMIUM PRO 072572



Pads - Patins (x4) 074958  
Included Alu 3 065178  
Included Alu 4 065185

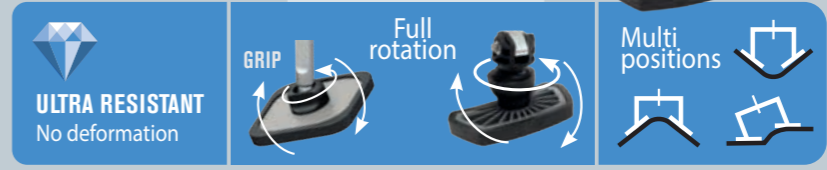

ULTRA RESISTANT No deformation

GRIP Full rotation

Multi positions

### ALU PULLER 051003

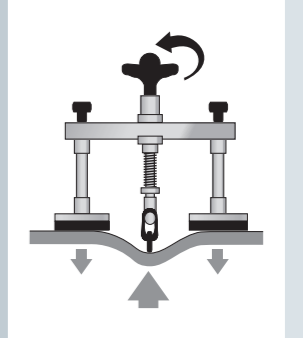
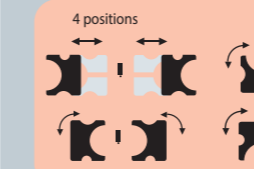

### STRAIGHT LINE LAMP - Lampe ligne droite - Dentline-laser 056770



### FAST PULLING RINGS - Anneaux de tirage rapide 058743

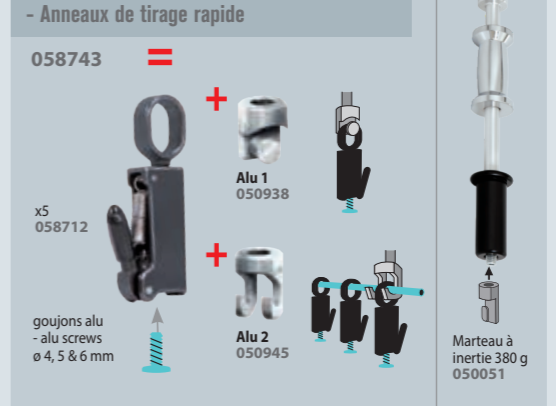

goujons alu - alu screws ø 4, 5 & 6 mm

### ALU HAMMERS - Marteaux alu 020986



Marteau à inertie 380 g 050051

### Heat gun - Décapeur thermique - Heißluftpistole 066311

I: 100/300°C (450 W)  
II: 300/650°C (1500 W)  
Air flow: 450 l/min



Affichage digital Digital display

### Gas hot air gun - Pistolet à air chaud autonome à gaz 060777



Bouteille de gaz incluse, gas cylinder included

### Blow torch - Lampe à souder - Lötlampe 052741



### Novacet+ (Butane/propane/propylene) 380ml/220g 040441



### Brushes - Brosses - Bürsten - Brosses - Cepillos 044258



### Thermal marking pencil - Crayon marqueur thermique 052765



### Freezer spray - Spray refroidisseur 048898



### Heat barrier spray - Spray barrière thermique 054325



### Infrared Thermometer - Thermomètre infrarouge 079922



-50 / +600°C  
-58 / +1112°F  
Adjustable emissivity: 0.10 ~ 1.00





# PULLING BARS

## 3 PRODUCT LINES

### 1 STANDARD

### 2 PREMIUM



### 3 PREMIUM PRO



## STANDARD

**Levelling lever**  
- Levier de débosselage  
- Zughebel

**050686**  
↓ 1.6 kg  
⊗ 79 x 12 x 17 cm / 1.9 kg

PATENTS REGISTERED NUMBERS  
001652108-0002  
EUROPEAN TRADEMARK & DESIGN

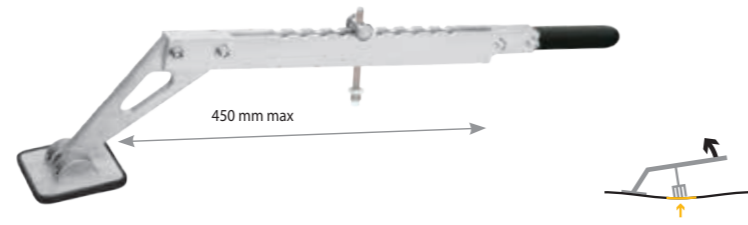

**Double action levelling bar**  
- Barre de débosselage double action  
- Zughebelbrücke

**053564**  
↓ 2.5 kg  
⊗ 77 x 12 x 13 cm / 3.2 kg

Licensed by  
BETAG.Innovation

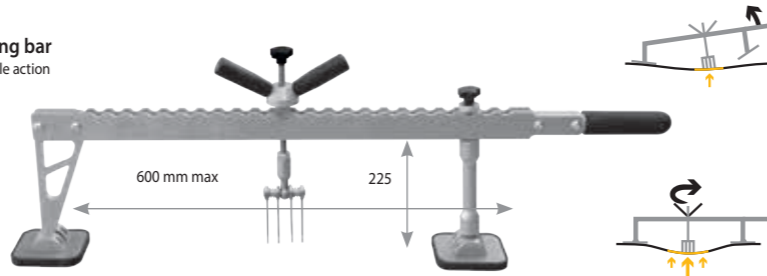

**Levelling bar**  
- Barre de débosselage  
- Zugbrücke

**050693**  
↓ 3.4 kg  
⊗ 87 x 17 x 19 cm / 4 kg

Licensed by  
BETAG.Innovation

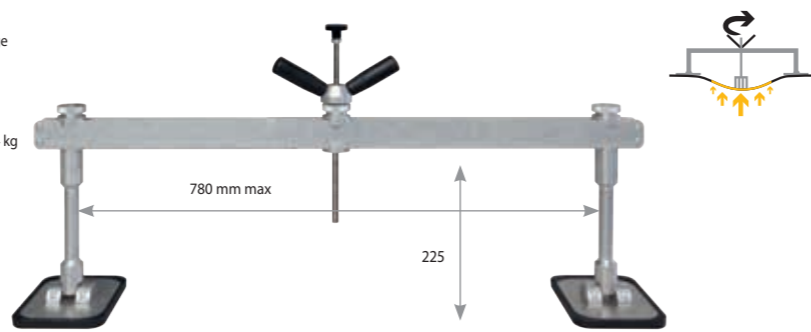

**Reinforced scissoring bar**  
- Barre de tirage renforcée  
- Scherenzugbrücke

**050716**  
↓ 5.1 kg  
⊗ 87 x 17 x 18 cm / 5.9 kg

PATENTS REGISTERED NUMBERS  
001652108-0001  
EUROPEAN TRADEMARK & DESIGN

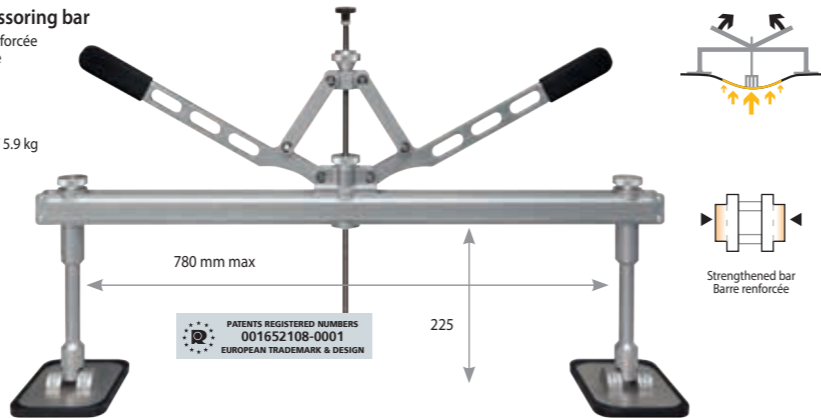

## SLIDE & LOCK

Removable system : pads and pulling systems  
Système amovible : patins et chariots de tirage



## LIGHTWEIGHT

Léger



## PREMIUM

**Premium levelling lever**  
- Levier de débosselage Premium  
- Premium Zughebel

**059290**  
↓ 1.6 kg  
⊗ 100 x 16 x 17 cm / 2.2 kg

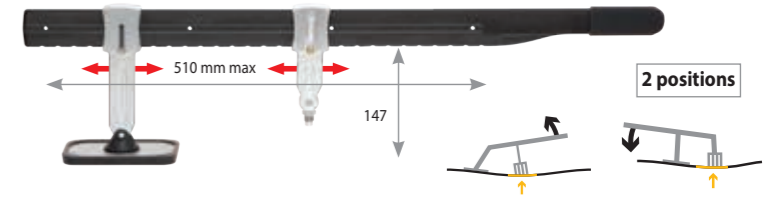

**Premium levelling bar**  
- Barre de débosselage Premium  
- Premium Zugbrücke

**059306**  
↓ 2.8 kg  
⊗ 79 x 30 x 13 cm / 3.2 kg

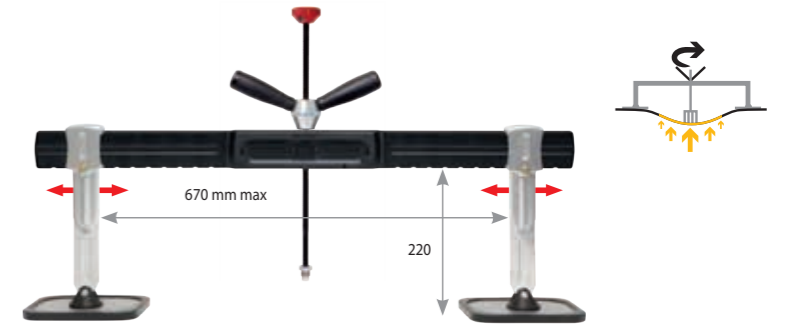

**Premium scissoring bar**  
- Barre de tirage Premium  
- Premium Scherenzugbrücke

**058996**  
↓ 3.1 kg  
⊗ 87 x 16 x 18 cm / 3.9 kg

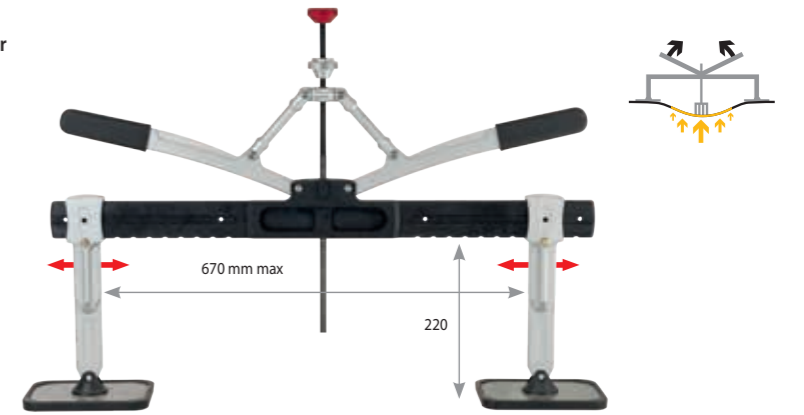

**Premium 1200 scissoring bar**  
- Barre de tirage 1200 renforcée Premium  
- Premium Scherenzugbrücke 1200

**059313**  
↓ 5.6 kg  
⊗ 127 x 26 x 9 cm / 6.2 kg

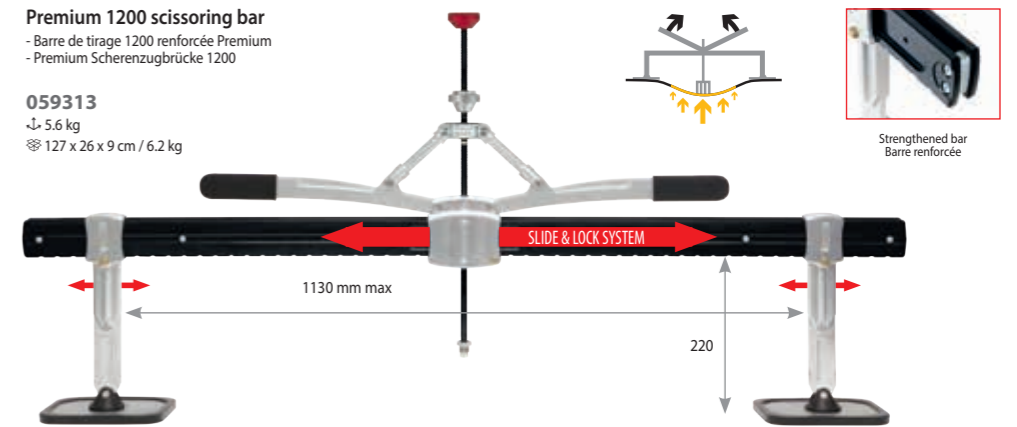

## OPTIONS

**Reinforced bar 1200 mm - Barre renforcée**  
051171

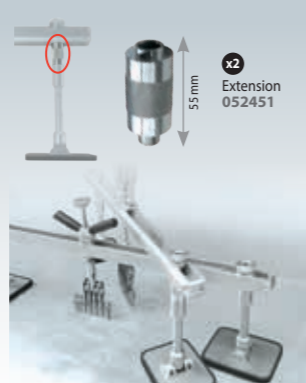
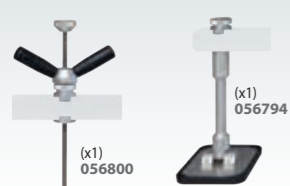
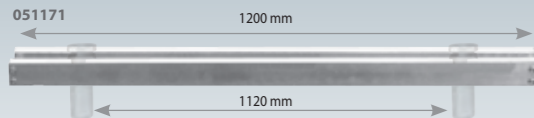

STANDARD

NEW

1 tooth hook  
Ø M10 / M14  
082021

STANDARD

PREMIUM (LONG FEET NEEDED)

4 tooth claw  
Ø M10 / M14  
049758

6 tooth claw  
Ø M10 / M14  
049734

8 tooth claw  
Ø M10 / M14  
049741



PREMIUM

2 teeth hook  
PREMIUM Ø M14  
059382

3 teeth hook  
PREMIUM Ø M14  
059658



## OPTIONS





**SUPER ERGONOMIC**

BREVET GYS PATENT PENDING GYS PATENT



**QUICK HOOK**

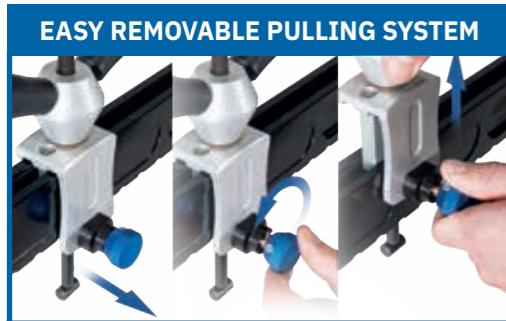
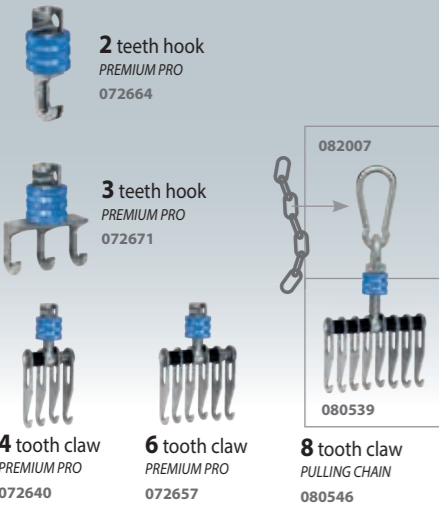

**EASY REMOVABLE PULLING SYSTEM**

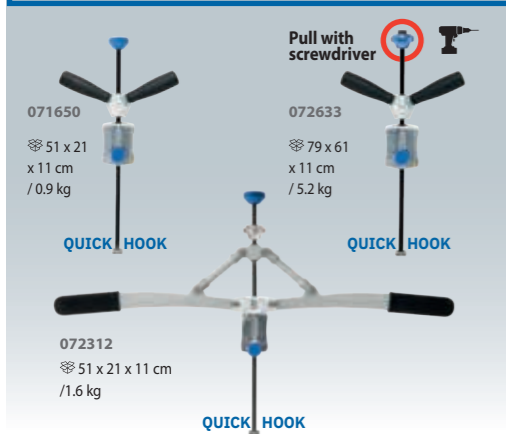

**PREMIUM PRO**

**Premium Pro Levelling lever**  
- Levier de débousselage Premium Pro  
- Premium Pro Zughebel

072619  
1.6 kg  
87 x 17 x 18 cm / 2.3 kg

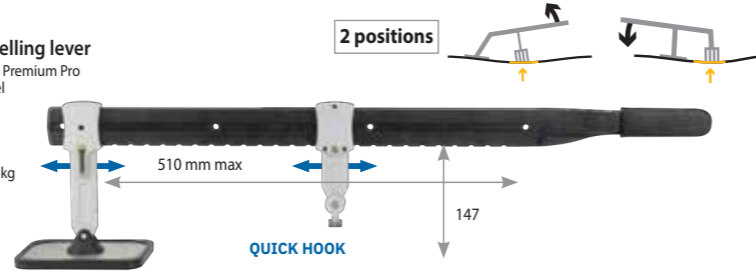

**Premium Pro Levelling bar 900mm / Single feet**  
- Barre de débousselage Premium Pro 900 mm  
- Premium Pro Zugbrücke 900 mm

071643  
120 x 26 x 8 cm / 4.4 kg  
3.8 kg

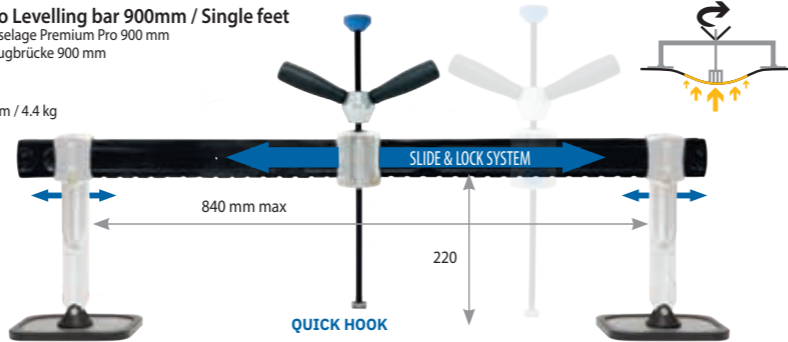

**Premium Pro Levelling bar 900mm / Double feet**  
- Barre de débousselage Premium Pro 900 mm  
- Premium Pro Zugbrücke 900 mm

080102  
3.8 kg

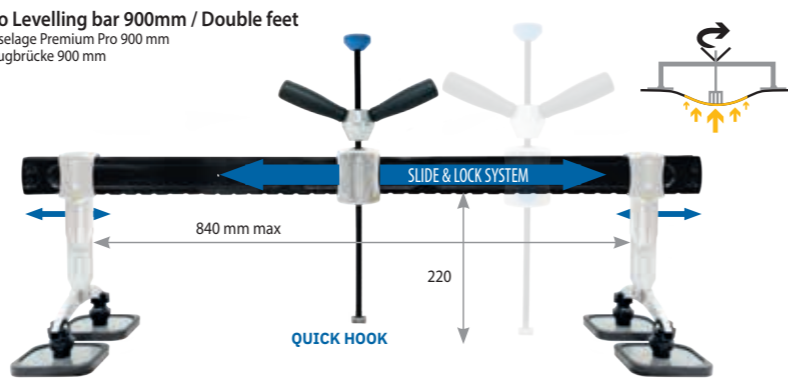

**Premium Pro Scissoring bar 900mm**  
- Barre de tirage Premium Pro 900 mm  
- Premium Pro Scherenzugbrücke 900 mm

072305  
103 x 30 x 13 cm / 5.2 kg  
4.5 kg

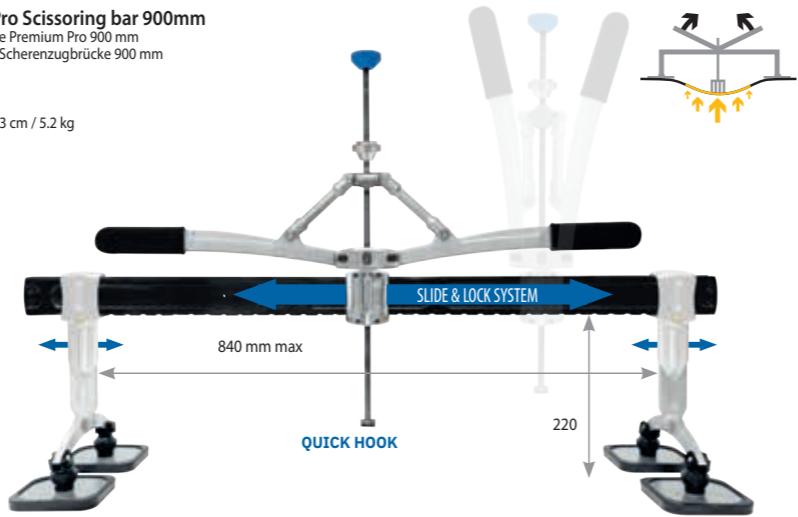

**Premium Pro Scissoring bar 1150 mm**  
- Barre de tirage Premium Pro 1150 mm  
- Premium Pro Scherenzugbrücke 1150 mm

072626  
124 x 7 x 7 cm / 3.1 kg



**PREMIUM BAR SMART HAND**

for Premium & Premium Pro  
072480







# DENT PULLING WORKSTATIONS

**A COMPLETE SOLUTION  
UNE SOLUTION COMPLÈTE  
KOMPLETTLÖSUNGEN**

## Compatibility

SPOT	Dent 600	Dent 1000	Universal 800	Weld 810	Weld 910	Dent 1600	Dent 1600 WD	Dentstation Pro WD
26/27.02	✓	✓	✓	✓		✓		✓
34.02/04	✓	✓	✓	✓		✓		✓
39.02/04	✓	✓	✓	✓		✓		✓
PRO 230/400	✓	✓	✓	✓		✓		✓
EXPERT 230/400	✓	✓	✓	✓		✓		✓
ALU 66	✓	✓	✓					✓
ALU PRO FV	✓	✓	✓					✓
COMBI 230 E.PRO						✓		✓
ARCPULL 200/350				✓	✓	✓		✓
COMBI ARCPULL						✓		✓
ARCPULL 700					✓	✓		✓

**Universal 800**  
 ↳ 60 x 48 x 83 cm  
 17,6 kg  
 ↳ 79 x 39 x 18 cm  
 18,1 kg  
 051331

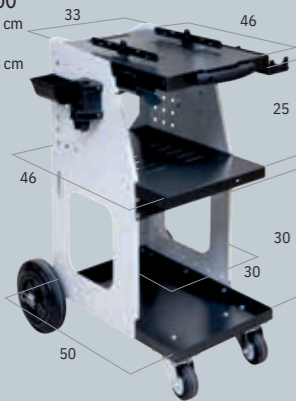

**Weld 810**  
 ↳ 77 x 50 x 84 cm  
 20,1 kg  
 ↳ 80 x 51 x 14 cm  
 21,6 kg  
 037489

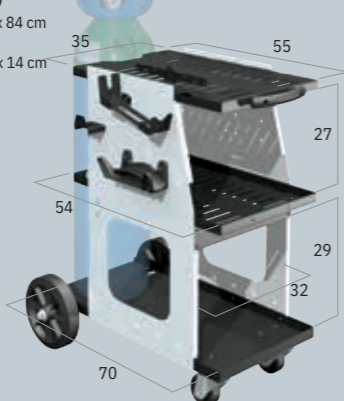

**Weld 910**  
 ↳ 89 x 52 x 84 cm  
 25 kg  
 ↳ 80 x 52 x 22 cm  
 27 kg  
 070967

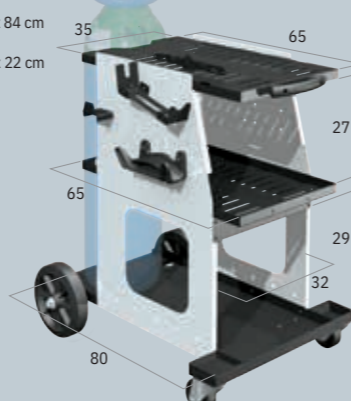

**Dent 1600**  
 ↳ 70 x 69 x 161 cm  
 / 35,8 kg  
 ↳ 103 x 66 x 22 cm  
 / 38,7 kg  
 072596

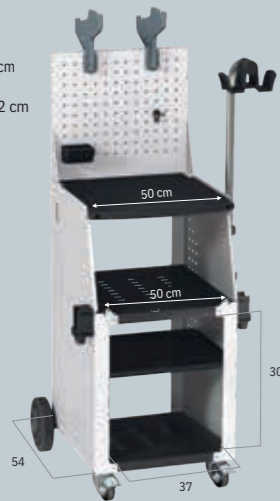

**Dent 1600 WD**  
 ↳ 71 x 70 x 161 cm  
 / 49,5 kg  
 ↳ 103 x 66 x 22 cm  
 / 52,4 kg  
 072169

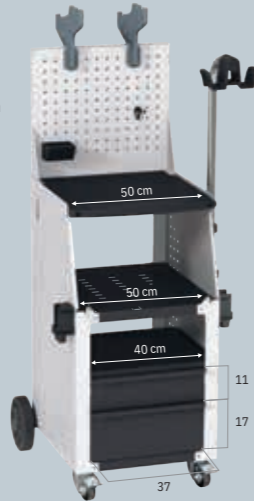

**Dentstation Pro WD**  
 ↳ 90 x 71 x 161 cm  
 / 65 kg  
 ↳ 120 x 80 x 28 cm  
 / 68,5 kg  
 072800



## CHARIOTS / TROLLEYS

**Dent 600**  
 ↳ 44 x 35 x 62 cm / 6,9 kg  
 ↳ 60 x 39 x 14 cm / 7,4 kg  
 072831

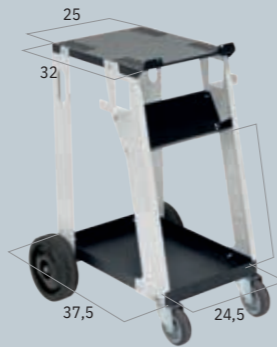

**Dent 1000**  
 ↳ 44 x 35 x 98 cm / 9,3 kg  
 ↳ 60 x 39 x 14 cm / 9,9 kg  
 072848



4 m³ support  
 for Dent 1600 /  
 1600 WD &  
 Dentstation Pro WD  
 059665



Cable support for  
 Spot 800, 1600  
 & Dentstation Pro WD  
 052284



Protection cover - Housse de protection  
 - Schutzhaube  
 for Universal 800  
 062733  
 for Spot 1600 & Dent 1600  
 048881  
 for Dentstation Pro  
 059870

**EASYLINER**



**PROLINER**



EASYLINER 39.02

EASYLINER PRO 230



PROLINER 39.02  
PROLINER 39.04

PROLINER PRO 230  
PROLINER PRO 400



PROLINER ALU PRO FV

PROLINER ARCPULL 200

## STEEL / ACIER / STAHL



GYSPOT  
(guns & consumables included)

## STEEL / ACIER / STAHL



GYSPOT  
(guns & consumables included)

## ALU



GYSPOT  
(guns & consumables included)

39.02  
053618  
☎ : 058521

PRO 230

072398

39.02  
035775

PRO 230

035799

ALU PRO FV

035836

ARCPULL 200

065260



## INCLUDED ACCESSORIES



DENT 1000  
072848



Dent box easy  
053632



Levelling bar double action  
053564

## INCLUDED ACCESSORIES



UNIVERSAL 800  
051331  
+ Cable support  
052284



Dent box easy  
050037



Levelling bar double action  
053564



UNIVERSAL 800  
051331  
+ Cable support  
052284



Weld 810  
037489  
+ Cable support  
052284



Alu puller  
051003



Arc puller premium  
065161



# SPEEDLINER STANDARD

\*\*\*  
COMPLETE  
SYSTEM



PRO 230, 400      EXPERT 200, 230, 400      COMBI 230 E.PRO      ARCPULL 200 + PRO 230, 400      ARCPULL 200 + EXPERT 200, 230, 400      ALU PRO FV

## STEEL / ACIER / STAHL



GYSPOT  
(guns & consumables included)



GYSPOT  
(guns & consumables included)



GYSPOT  
(guns & consumables included)



GYSPOT  
(guns & consumables included)

PRO 230 074446	EXPERT 200 074460	COMBI 230 E PRO 074491	ARCPULL 200 + PRO 230 074507	ARCPULL 200 + EXPERT 200 074521	ALU PRO FV 074552
PRO 400 074453	EXPERT 230 074477		ARCPULL 200 + PRO 400 074514	ARCPULL 200 + EXPERT 230 074538	
	EXPERT 400 074484			ARCPULL 200 + EXPERT 400 074545	

### INCLUDED ACCESSORIES

DENT 1600 072596	Cable support 052284	Levelling bar 850 mm 050693	052451
Magnetic earth 049666	Multihook heads 049758+049734	Levelling bar 050686	Ringmatic 052154
Alu puller 051003	Cable support 052284	Arc puller premium 065161	Cable support 052284 + 4 m support 059665
Stainless steel brush 044258 Alu Box 05 & 6 048195		Infrared Thermometer 079922	Hot air gun 650°C 066311

### INCLUDED ACCESSORIES

DENT 1600 072596	Cable support 052284
Levelling bar 850 mm 050693	
Alu hammers 020986	Set of pencil punches with 6 teflon tips 052888
Multihook heads 049758	Alu puller 051003
Stainless steel brush 044258 Alu Box 05 & 6 048195	
Infrared Thermometer 079922	Hot air gun 650°C 066311

Steel Speedliner without generator (excluded Ringmatic) : 035058





# SPEEDLINER PREMIUM

★★★★  
COMPLETE SYSTEM



PRO 230, 400



EXPERT 200, 230, 400



COMBI 230 E.PRO



ARCPULL 200  
+ PRO 230, 400



ARCPULL 200  
+ EXPERT 200, 230, 400



ARCPULL 200, 350



## STEEL / ACIER / STAHL



GYSPOT  
(guns & consumables included)



GYSPOT  
(guns & consumables included)



GYSPOT  
(guns & consumables included)

## ALU



GYSPOT  
(guns & consumables included)

PRO 230 073883	EXPERT 200 073906	COMBI 230 E PRO 073968	COMBI ARCPULL 074569	ARCPULL 200 + PRO 230 073975	ARCPULL 200 + EXPERT 200 073913	ARCPULL 200 073999	ARCPULL 350 083042
PRO 400 073890	EXPERT 230 073920			ARCPULL 200 + PRO 400 073982	ARCPULL 200 + EXPERT 230 073937	077317 (without HOT AIR GUN)	
	EXPERT 400 073944				ARCPULL 200 + EXPERT 400 073951		

### INCLUDED ACCESSORIES

DENT 1600 WD 072169	Cable support 052284	Premium levelling bar 720 mm 059306
Hook head 049758 + 059658 + 059382	Premium levelling lever 059290	
Magnetic earth 049666	Manuspot 050679	Dent box consumables 051515 + 3 lifting rods 050792
Fast pulling rings (x5) 058712 + Alu puller 051003 + Cable support 052284	Arc puller premium 065161	Cable support 052284 4 m³ support 059665

### INCLUDED ACCESSORIES

DENT 1600 WD 072169 Cable support 052284	Alu Ring Box 1 mm 059412 Premium 2-teeth hook 059382
Arc puller premium 065161	Premium levelling bar 720 mm 059306
Alu hammers 020986	Infrared Thermometer 079922 Hot air gun 650°C 066311
Set of pencil punches with 6 teflon tips 052888	3 lifting rods 050792
Stainless steel brush 044258	4 m³ support 059665



# SPEEDLINER PREMIUM PRO



PRO 230, 400



EXPERT 200, 400  
+ ARCPULL 200, 350



COMBI ARCPULL



ARCPULL 200, 350

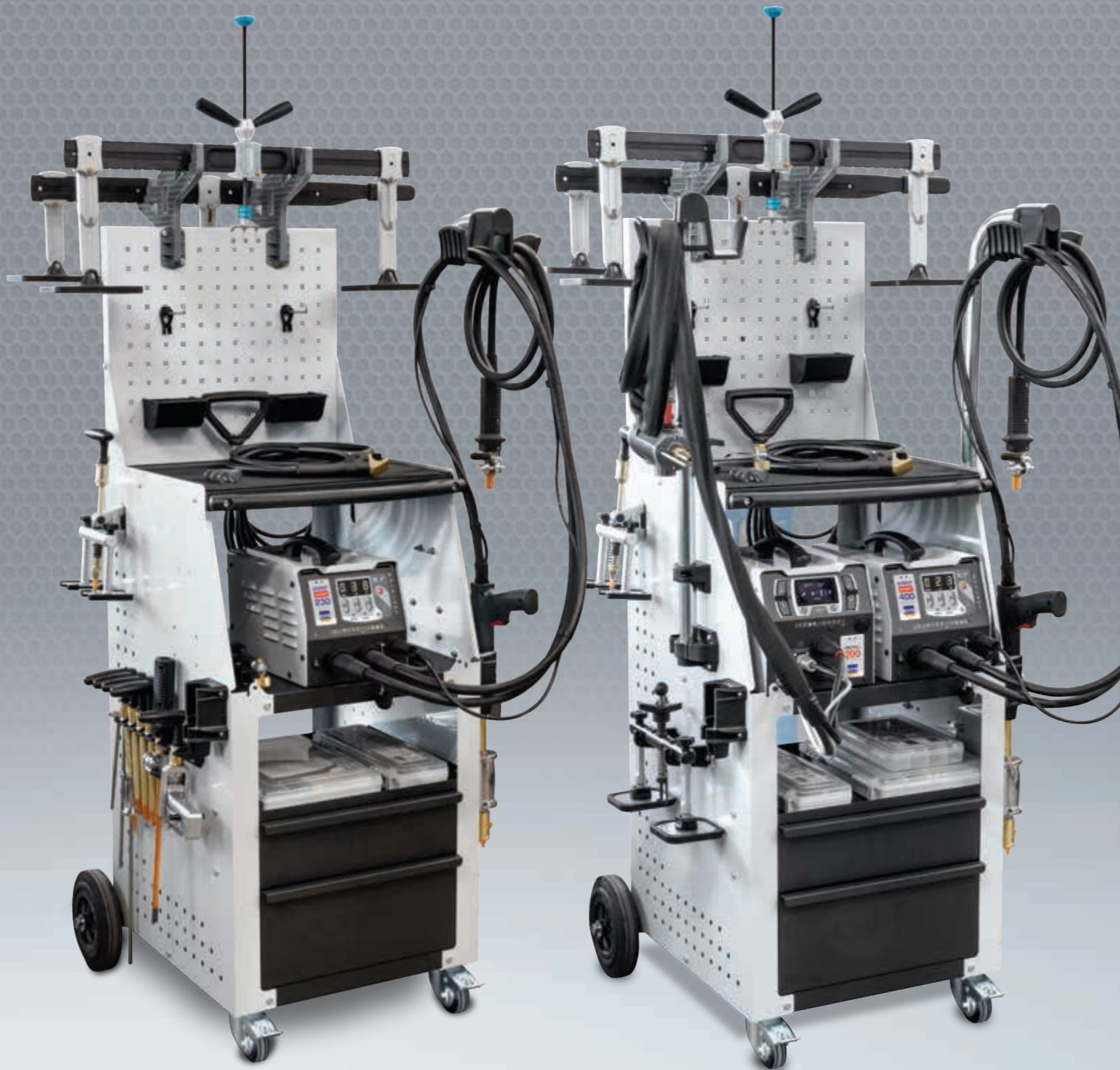

## STEEL / ACIER / STAHL



GYSPOT  
(guns & consumables included)

## ALU + STEEL / ACIER / STAHL



GYSPOT  
(guns & consumables included)



GYSPOT  
(guns & consumables included)

## ALU



GYSPOT  
(guns & consumables included)

EXPERT 230	EXPERT 400	EXPERT 400 + ARCPULL 200	EXPERT 400 + ARCPULL 350	COMBI ARCPULL	ARCPULL 200	ARCPULL 350
080201	080218	080232	083028	080225	080256	083035
		EXPERT 200 + ARCPULL 200				
		080553				

### INCLUDED ACCESSORIES



Dent 1600 WD  
072169



Premium Pro levelling bar 900 mm  
071643



Premium Pro levelling bar  
072619



Ringmatic  
052154



Manuspot  
050679



Premium Pro teeth hook  
072671 + 072664 + 072640



Manual pulling handle  
057289

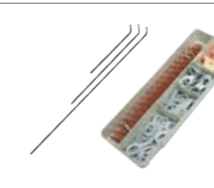

3 lifting rods  
050792  
Dent box consumables  
051515



Magnetic earth  
049666



Cable support  
052284  
4 m support  
059665  
Arc Puller Premium Pro  
072572

### INCLUDED ACCESSORIES



Dent 1600 WD  
072169



Alu Ring Box 1 mm



072664



4 m support  
059665



Premium Pro levelling bar 900 mm  
071643



Set of pencil punches with 6  
teflon tips  
052888



Arc Puller Premium Pro  
072572



Alu hammers  
020986



Infrared Thermometer  
079922  
Hot air gun 650°C  
066311



Stainless steel brush  
044258



3 lifting rods  
050792



# DENTSTATION STANDARD



39.02, 39.04    PRO 230, 400    EXPERT 200, 230, 400    COMBI 230 E.PRO    ARCPULL 200 + PRO 230, 400    ARCPULL 200 + EXPERT 200, 230, 400

\*\*\*  
COMPLETE  
SYSTEM

## STEEL / ACIER / STAHL



GYSPOT  
(guns & consumables included)

## ALU + STEEL / ACIER / STAHL



GYSPOT  
(guns & consumables included)



GYSPOT  
(guns & consumables included)

39.02	PRO 230	EXPERT 200	COMBI 230 E PRO	ARCPULL 200 + PRO 230	ARCPULL 200 + EXPERT 200
078161	078208	078321	078529	078222	078338
39.04	PRO 400	EXPERT 230		ARCPULL 200 + PRO 400	ARCPULL 200 + EXPERT 230
078185	078260	078369		078284	078384
		EXPERT 400 078444			ARCPULL 200 + EXPERT 400 078468



### INCLUDED ACCESSORIES

<p>Dentstation Pro WD 072800 Fixing kit 051362</p>	<p>Double pads 050723</p>	<p>Levelling bar 850 mm 050693</p>	<p>Scissoring bar 050716</p>
<p>Magnetic earth 049666</p>	<p>Multihook heads 049758 +049734 +049741</p>	<p>Levelling lever 050686</p>	<p>Strengthened bar 1200 mm 051171 Extensions (x2) 052451</p>
<p>Fast pulling rings (x5) 058712 + Alu puller 051003</p>	<p>Manuspot 050679</p>	<p>Dent box consumables 051515 3 lifting rods 050792 Empty box 320x113mm</p>	<p>Manual pulling handle 057289</p>
<p>Cable support 052284</p>	<p>Arc puller premium 065161</p>	<p>Cable support 052284 + Alu puller 051003</p>	<p>Cable support 052284 + 4 m support 059665 + Flanges (x 2) 062146</p>



# DENTSTATION PREMIUM



PRO 230, 400



EXPERT 200, 230, 400



COMBI 230 E.PRO  
COMBI ARCPULL



ARCPULL 200  
+ PRO 230, 400



ARCPULL 200  
+ EXPERT 200, 230, 400

★ ★ ★ ★  
COMPLETE SYSTEM

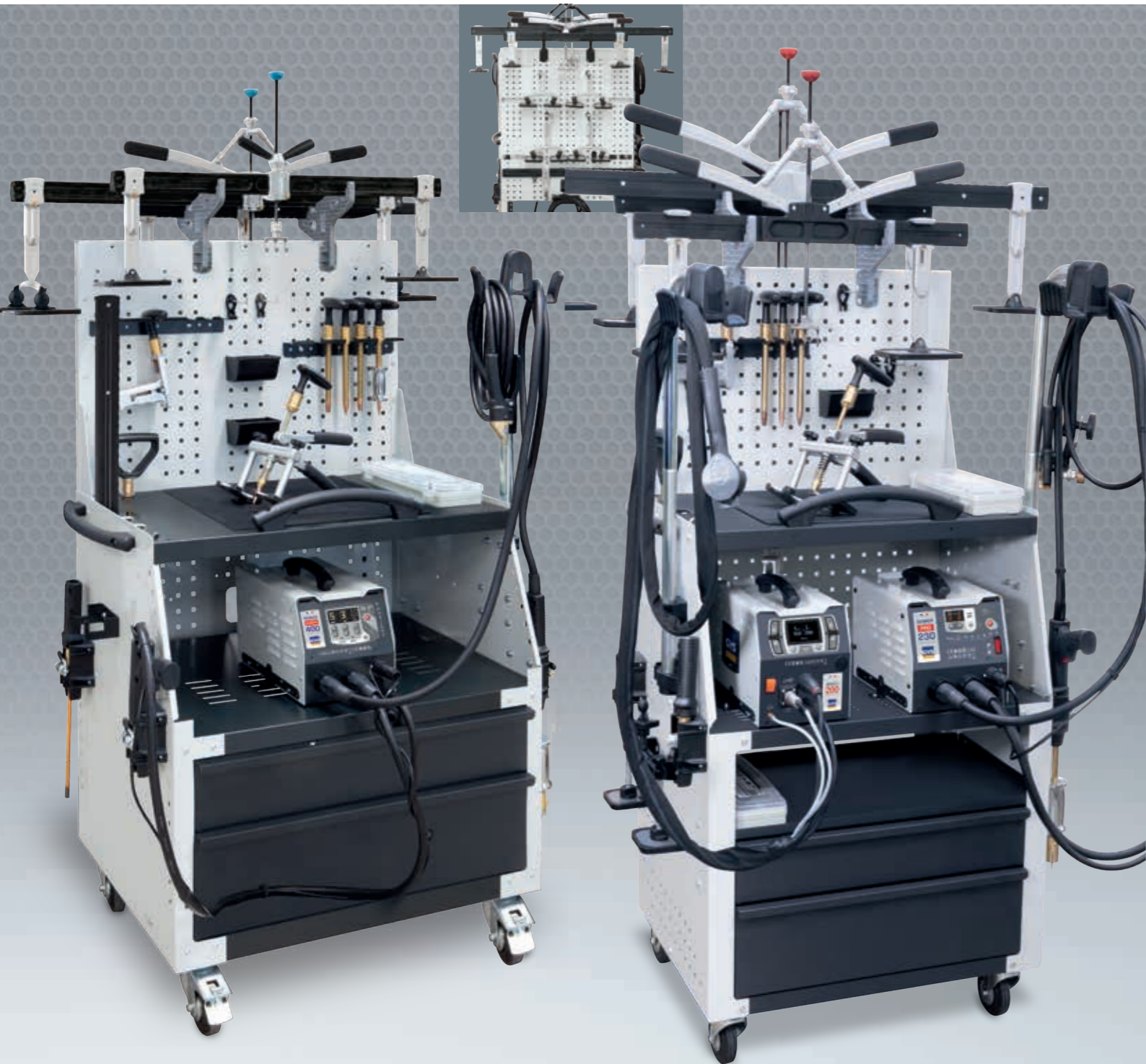

## STEEL / ACIER / STAHL



GYSPOT  
(guns & consumables included)

## ALU + STEEL / ACIER / STAHL



GYSPOT  
(guns & consumables included)



GYSPOT  
(guns & consumables included)

<b>PRO 230</b> 078239	<b>EXPERT 200</b> 078345	<b>COMBI 230 E PRO</b> 078543	<b>COMBI ARCPULL</b> 078567	<b>ARCPULL 200 + PRO 230</b> 078253	<b>ARCPULL 200 + EXPERT 200</b> 078352
<b>PRO 400</b> 078291	<b>EXPERT 230</b> 078406			<b>ARCPULL 200 + PRO 400</b> 078314	<b>ARCPULL 200 + EXPERT 230</b> 078420
	<b>EXPERT 400</b> 078482				<b>ARCPULL 200 + EXPERT 400</b> 078505

### INCLUDED ACCESSORIES

x6 x2	Manuspot 050679	Premium levelling bar 720 mm 059306	Premium levelling lever 059290
Dentstation Pro WD 072800 Fixing kit 051362	Hook head 049734 + 059658 + 059382	Premium scissoring bar 720 mm 058996	Premium scissoring bar 1200 mm 059313
Magnetic earth 049666	Premium double pads support 150 mm (x2) 059351 + 220 mm (x2) 059375	Dent box consumables 051515 3 lifting rods 050792 Empty box 320x113mm	Manual pulling handle 057289
		Ringmatic 052154	

Fast pulling rings (x5) 058712 Alu puller 051003 Cable support 052284	Cable support 052284 4 m <sup>2</sup> support 059665 Flanges (x 2) 062146 Arc puller premium 065161	Arc puller premium 065161	Cable support 052284 4 m <sup>2</sup> support 059665 Flanges (x 2) 062146
--	--	------------------------------	--



# DENTSTATION PREMIUM PRO



EXPERT 230, 400



COMBI ARCPULL



EXPERT 400 + ARCPULL 200, 350



ARCPULL 200, 350

## STEEL / ACIER / STAHL



1 BOX GYSOT (guns & consumables included)

## ALU + STEEL / ACIER / STAHL



1 BOX GYSOT (guns & consumables included)

## ALU



1 BOX GYSOT (guns & consumables included)

<b>EXPERT 230</b>	<b>EXPERT 400</b>	<b>EXPERT 400 + ARCPULL 200</b>	<b>EXPERT 400 + ARCPULL 350</b>	<b>COMBI ARCPULL</b>	<b>ARCPULL 200</b>	<b>ARCPULL 350</b>
080133	080140	080164	083004	080157	080461	083011

### INCLUDED ACCESSORIES



1 BOX Dentstation Pro WD 072800



Premium pro levelling bar 900mm 071643



Premium pro levelling lever 072619  
Premium pro bar 1184 mm 072626



Manuspot 050679

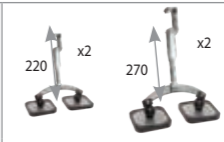

x2 220 x2 270  
(x2) 059375 + (x2) 072688



Dent box consumables 051515  
3 lifting rods 050792  
Empty box 320x113mm



Magnetic earth 049566  
Ringmatic 052154  
Manual pulling handle 057289

1 BOX STEEL ACCESSORIES PACK V2 080126

### INCLUDED ACCESSORIES



1 BOX Dentstation Pro WD 072800



Premium pro levelling bar 900mm 071643 (x2) 059375



072664 + 072640 + 071650 Alu Ring Box 1 mm 059412



Alu hammers 020986



Arc Puller Premium Pro 072572



Set of pencil punches with 6 teflon tips 052888



3 lifting rods 050792



Stainless steel brush 044258

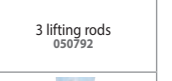

Infrared Thermometer 079922



Hot air gun 650°C 066311



4 m³ support 059665

1 BOX ARCPULL ACCESSORIES PACK 080485



1 BOX ALU ACCESSORIES PACK 073838

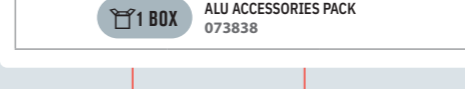

1 BOX ARCPULL ACCESSORIES PACK 080485





# PULLING SYSTEMS

AIRFIX DRAW ALIGNER	38
DRAW ALIGNER	40
FRAME STRAIGHTENING	42



## DRAW ALIGNER



- Designed for
- ★ TIME SAVING
  - ★ DURABILITY
  - ★ MAXIMUM GRIP

4 pads :  
**Seal protection,  
Perfect stability**

4 patins : protection du joint, stabilité parfaite  
4 Pads: Dichtungsschutz, perfekte Stabilität  
4 piedini: protezione sigillata, perfetta stabilità

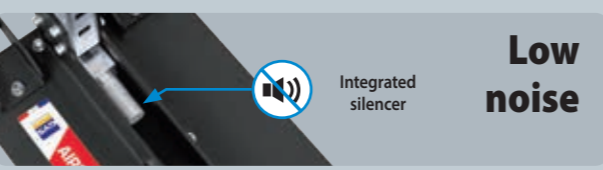
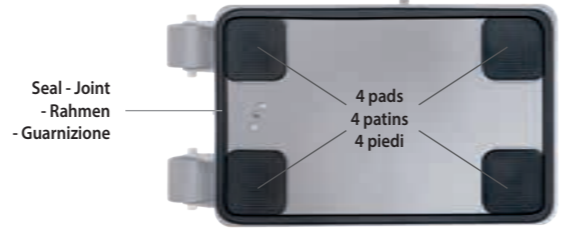

## AIRFIX DRAW ALIGNER

Air 5-8 bars  
077379  
080669



**350 kg**

**Uniform pulling force**

Force de tirage uniforme  
Gleichmäßige Zugkraft  
Forza di spinta uniforme

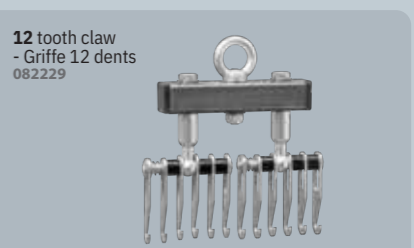
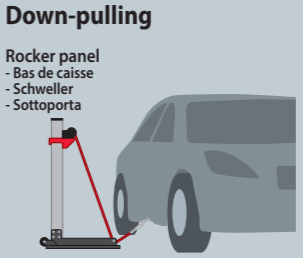
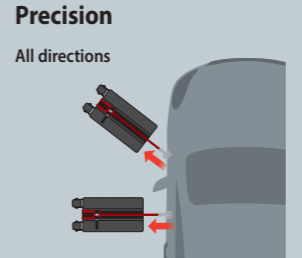
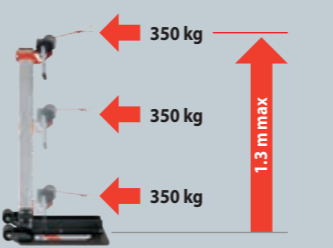



# PULLING SYSTEMS

**DRAW ALIGNER**

Draw aligner - Équerre de tirage - Schnellausbeul-Richtausleger  
052475

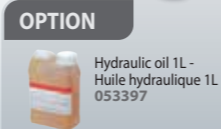
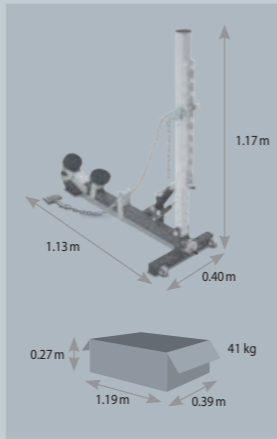
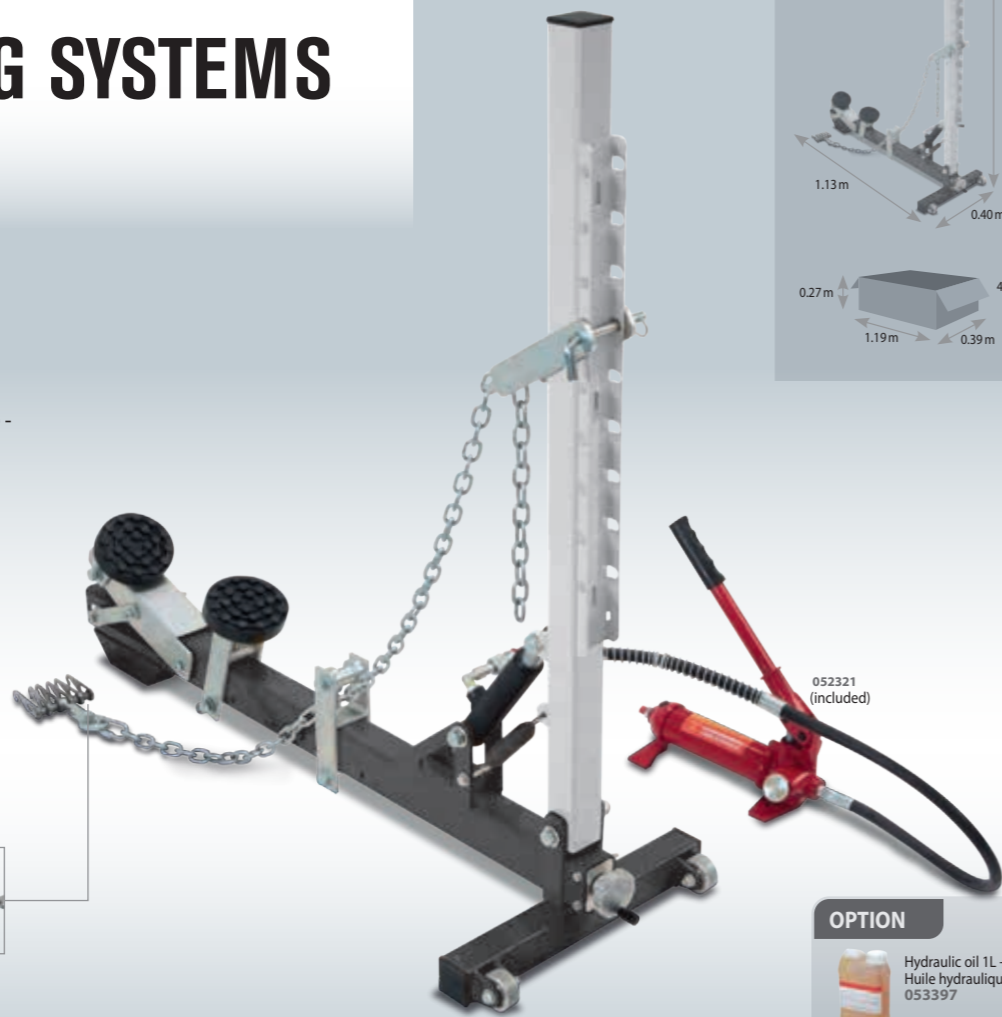
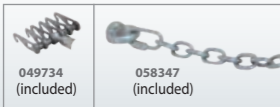
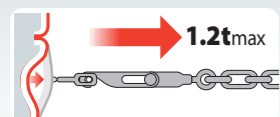
**INCLUDED**

Wedge for rocker panel - Cône pour bas de caisse

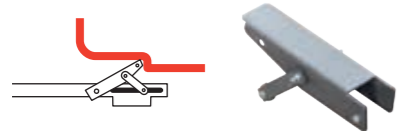

Pads kit for rocker panel - Kit patins pour bas de caisse

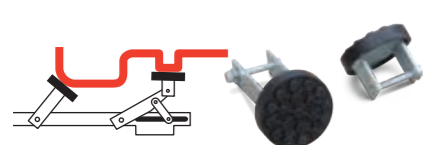
**OPTION**

Rocker panel arms for draw aligner - Bras de bas de caisse - Abstütztraverse für Richtausleger

052581

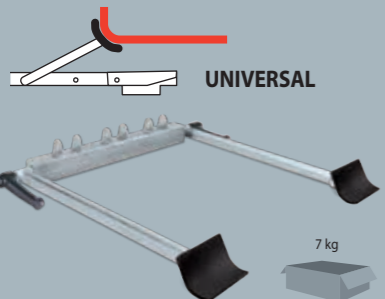
**OPTION**

12 tooth claw for pulling chain 082229

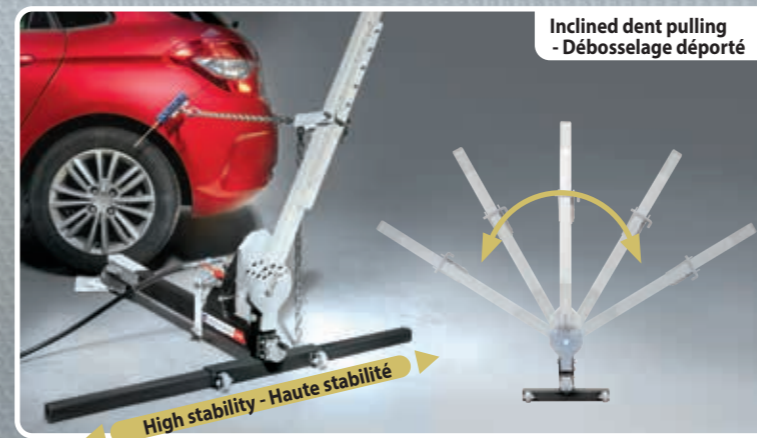
**DRAW ALIGNER PRO**

069244

**INCLUDED**

Plate under the wheel - Cône sous roue  
Compatible with Draw Aligner & Draw Aligner Pro 076693



Wedge for rocker panel - Cône pour bas de caisse

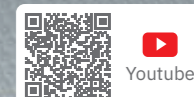
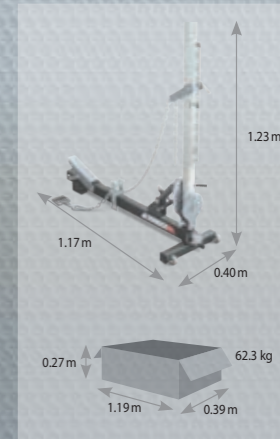
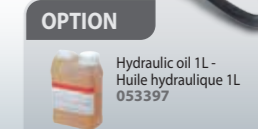
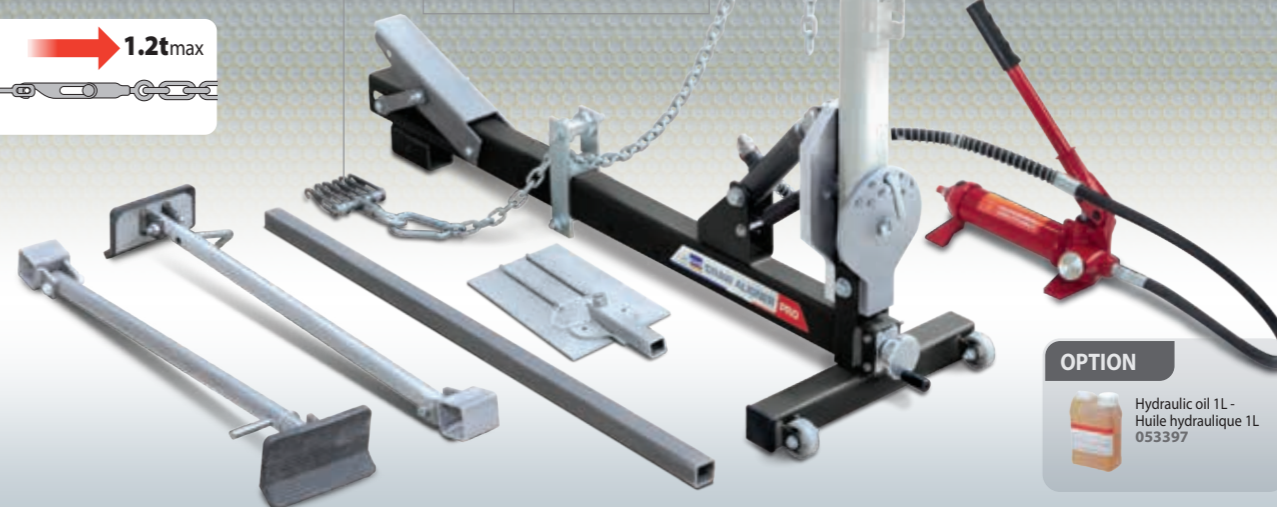
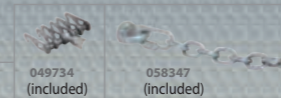
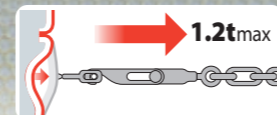

Rocker panel arms and stabilisation bar - Kit bras de bas de caisse et barre de stabilisation

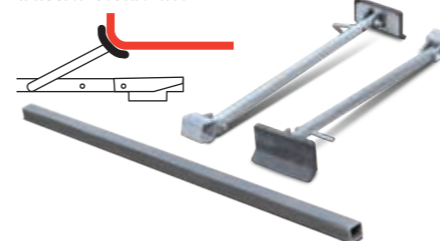
**OPTIONS**

Pads kit for rocker panel - Kit patins pour bas de caisse 071278

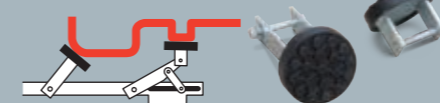



**ELECTRO POWER - Zug-Druckpresse**

with accessories : 057425



**INCLUDED**

Accessories kit : 425x620x150 mm  
Accessories kit  
Total weight: 20 kg



057418

Standard kit : 425x620x210 mm  
Standard kit  
Total weight: 18 kg



057401

Li-Ion battery 058514

**OPTION**

Pince écarteur 079496

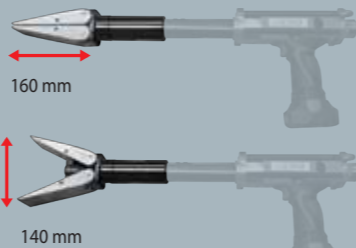

-PULLING POWER: 5 Ton.  
-PUSHING POWER: 5 Ton.  
-PISTON  
-STROKE: 130 mm

Spreading / Estensione

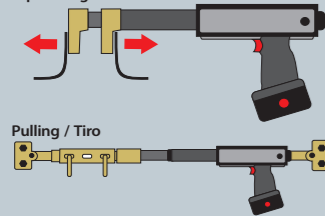

Pressing / Compressione

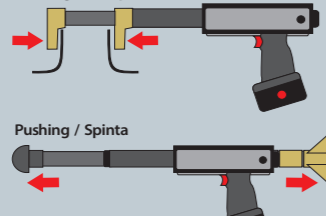

Pulling / Tiro

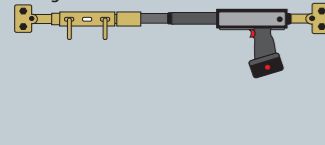

Pushing / Spinta

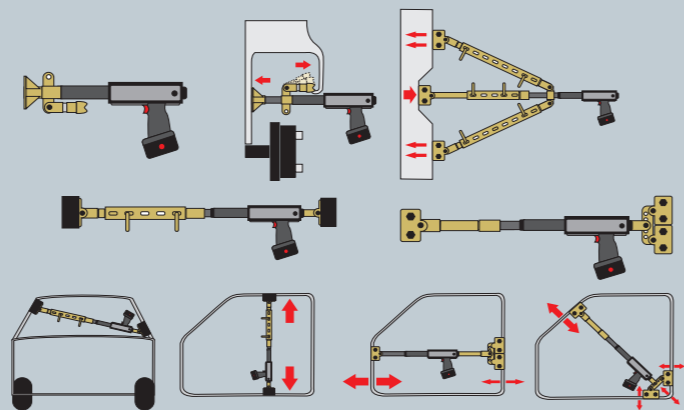
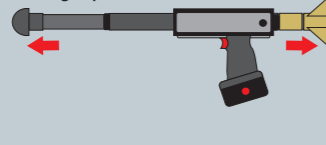

**ANCHOR BAR - Barre d'ancrage - Türspanner**

MADE IN TAIWAN

053045

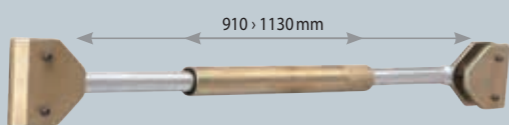

053052



**INERTIA HAMMER KIT - Kit marteau à inertie - Ausziehhammer kit**

Inertia hammer kit  
- Kit marteau à inertie  
- Ausziehhammer kit  
051928

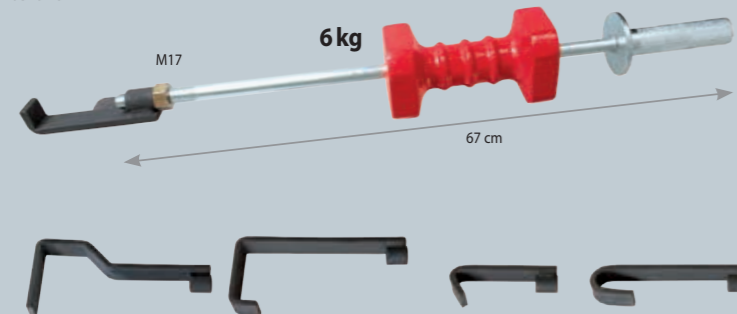

**POWER-PULLER 4T**

059740



**HYDRAULIC CYLINDER KIT - Coffret vérin hydraulique - Hydraulischer Drucksatz**

MADE IN CHINA

**OPTION**



Hydraulic oil 1L - Huile hydraulique 1L 053397

**BASIC 4T**  
052345



**BASIC 10T**  
052338

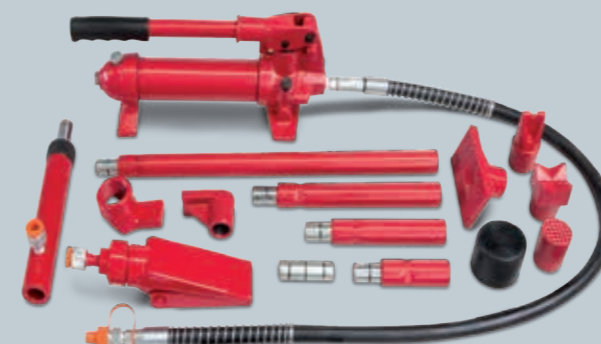

**PRO 4T**  
057432



**PRO 10T**  
057449



**MEASURING TOOLS - Mesures - Vermessung**

BODYMETER, Mechanical measurements

052130



GYSMETER, Electronic measurements

052093



Measuring report

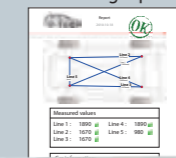

Light weight measuring arm with an easy to read digital display



**SWIVEL CLAMP**  
- Pince pivotante



**PULL CLAMPS - Pincés de tirage - Ziehwerkzeuge**

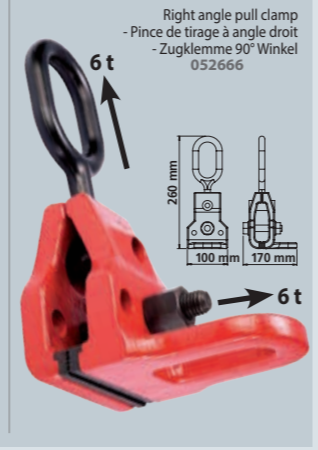
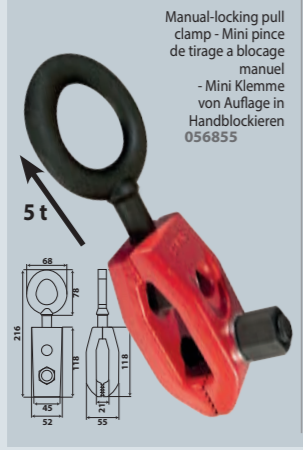

**PULL HOOK - Crochet de tirage - Ziehwerkzeuge**

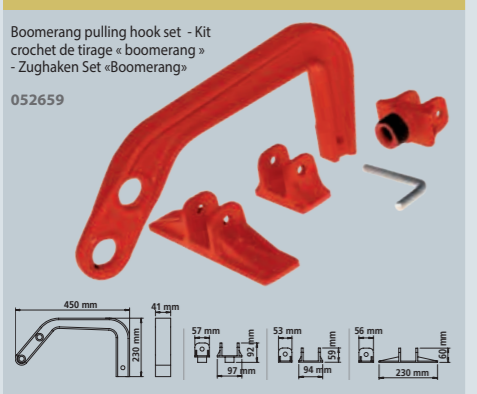

**ARCH HOOKS - Passage de roue**

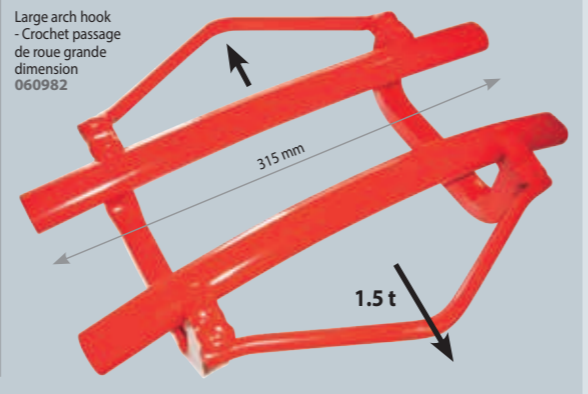
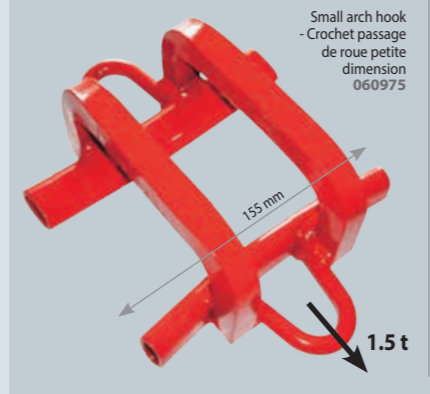

**PULLING CHAIN - Chaînes de tirage - Ziehwerkzeuge**

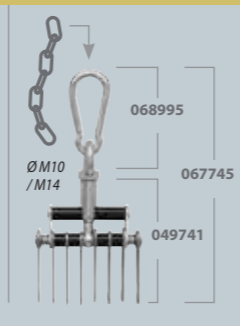
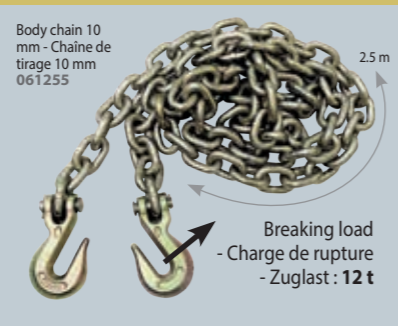
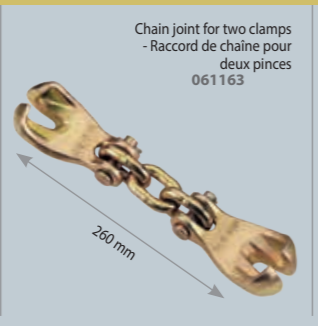
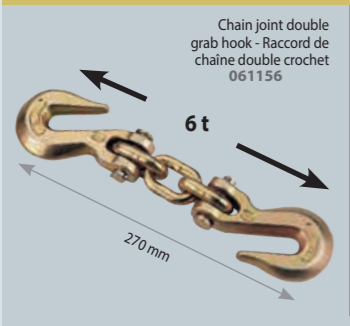

**WIDE PULL CLAMPS - Pincés de tirage larges**

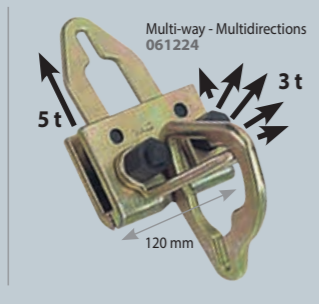
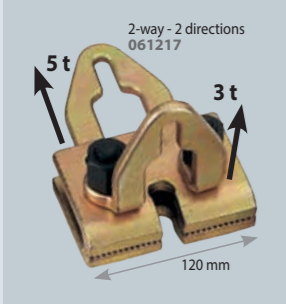

**SMALL PULL CLAMPS - Pincés de tirage faible largeur**

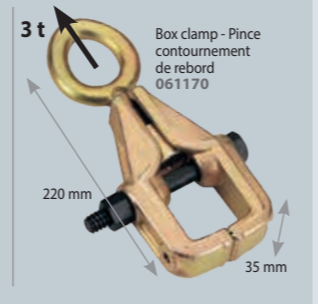
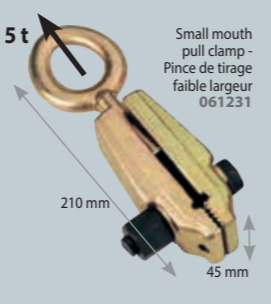

**MULTIPLE PULL CLAMP**  
- Pince de tirage multiple

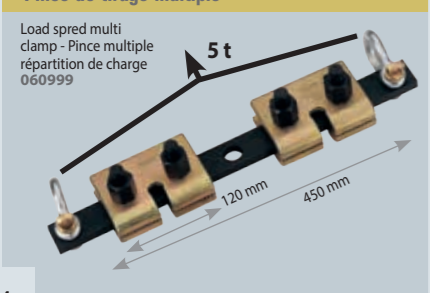

**45 MM SCISSORS CLAMP**  
- Pince ciseaux largeur 45 mm

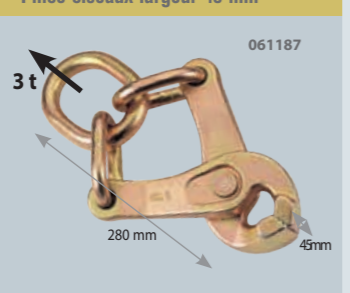

**90 DEGREE CORNER CLAMP**  
- Pince de tirage pour angle 90°



**C TYPE CLAMP**  
- Pince de tirage type C



**SMART SATELLITE - Satellite intelligent- Satellite Komplett-Kit**

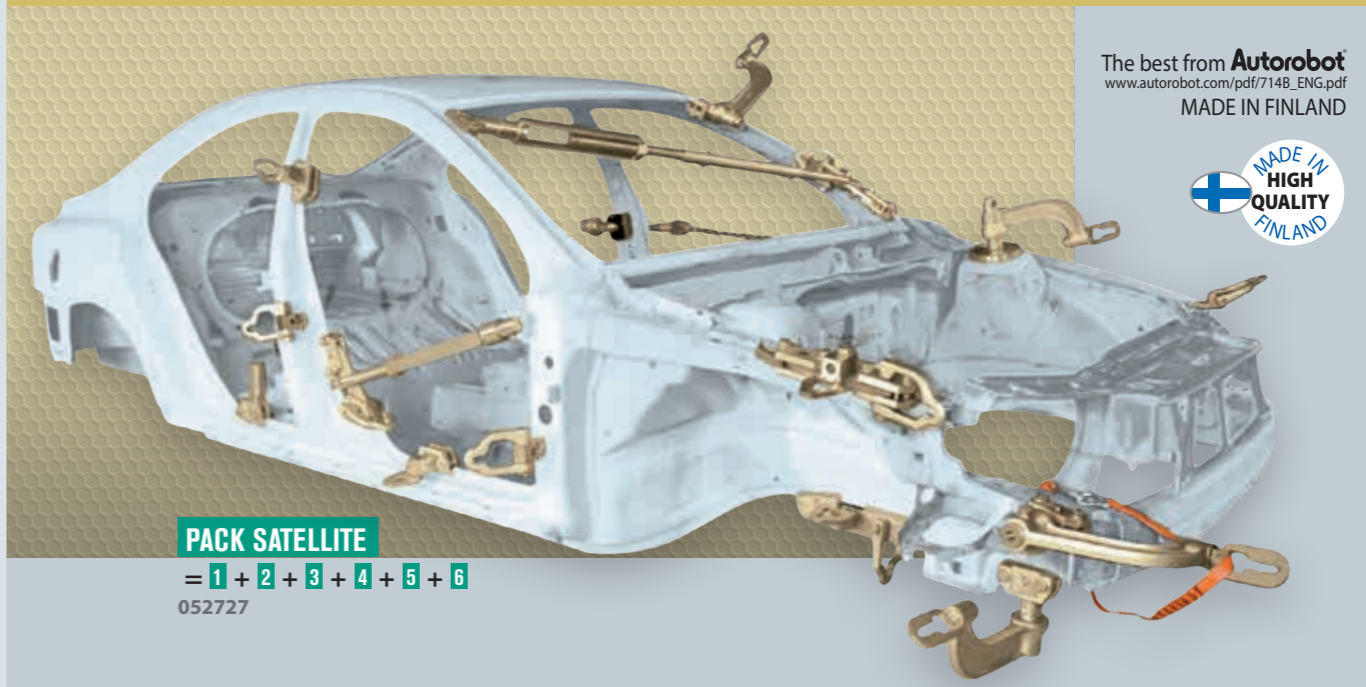

The best from **Autorobot**  
www.autorobot.com/pdf/7148\_ENG.pdf  
MADE IN FINLAND



**PACK SATELLITE**  
= 1 + 2 + 3 + 4 + 5 + 6  
052727

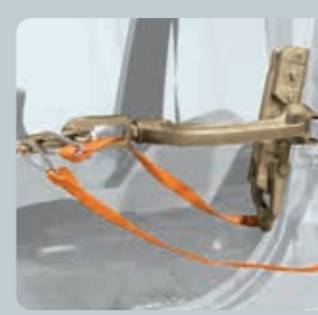
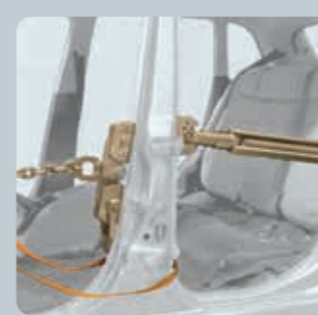

**PINCE DE TIRAGE MULTI-USAGE**  
- Versatile pulling clamp  
- Multifunktions-Zugklemme

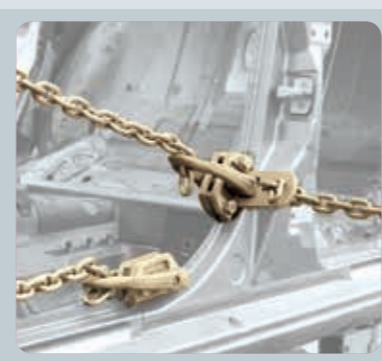

**WELDING SHEETS KIT WITH CLAMP**  
- Kit plaques à souder et pince





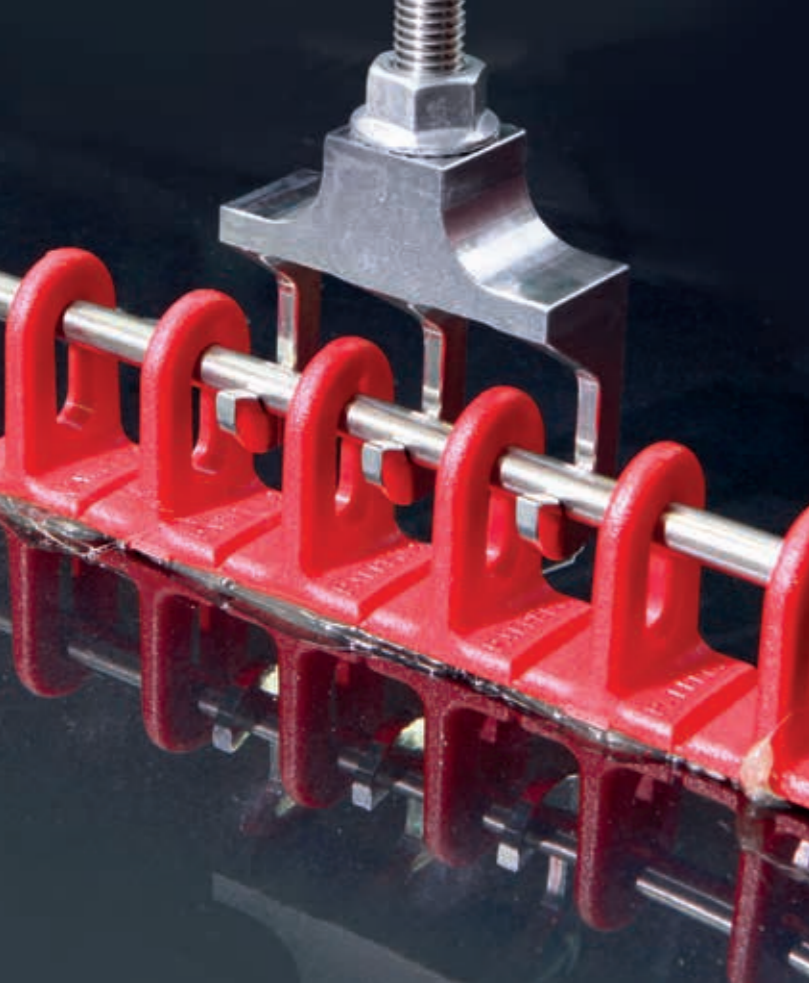

# PAINTLESS DENT REPAIR + GLUE PULLING REPAIR

## DENT PULLING INDUCTOR

- Inducteur débosselage - Dellenmatrix

GYS  
DUCTION  
AUTO + Dent pulling  
inductor  
054776

= GYS  
DUCTION AUTO  
DENT REPAIR  
054981



Youtube



Licensed by  
BETAG.Innovation

🔌	🔌	⚡	Freq.	INTEGRATED TECHNOLOGY	❄️	Cable (m)	📦	📏
50 Hz	A	W	kHz	PFC	FV	Liquid Cooling	Inductor	LxWxH cm / kg
230V, 1~	16	2 400	35+120	▪	▪	—	2 2.5	52 x 30 x 37 / 9.4
								37 x 21 x 37 / 7.5

## DENT PULLING INDUCTOR

- Inspection carrosserie - Ausbeul Induktor

Planche flexible pour inspection de la carrosserie - Ausbeul-Matrix  
Ø 800 mm  
059122

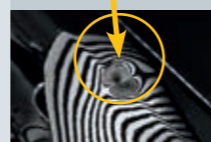

OPTION  
Freezer spray  
- Spray refroidisseur  
-50 °C  
400 ml  
(x 12)  
048898

## PAINTLESS DENT REPAIR MAGNETIC KIT

- Kit magnétique de débosselage sans peinture  
- Magnetisches Ausbeul-Kit

053168

EXELTOOLS



1010 mm - 40"

705 mm - 28"

610 mm - 24"

510 mm - 20"

## DENT PULLING KIT (PAINTLESS)

- Kit débosselage sans peinture - Dellenausbeulhebel-Set

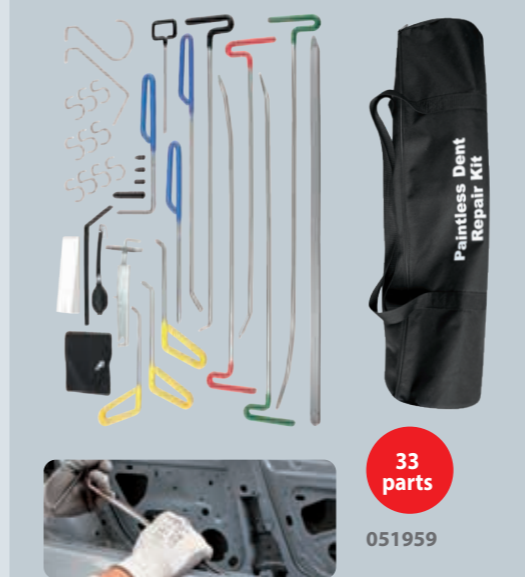

33  
parts

051959

## AIR CUSHION KIT

- Kit coussins gonflables - Luftpolster-Spreizkissen-Satz



051942

## PAINTLESS DENT REPAIR LAMPS

- Lampes de débosselage  
- Ausbeullampe

ULTRA LIGHT  
CARBON X40 PW  
053175

EXELTOOLS

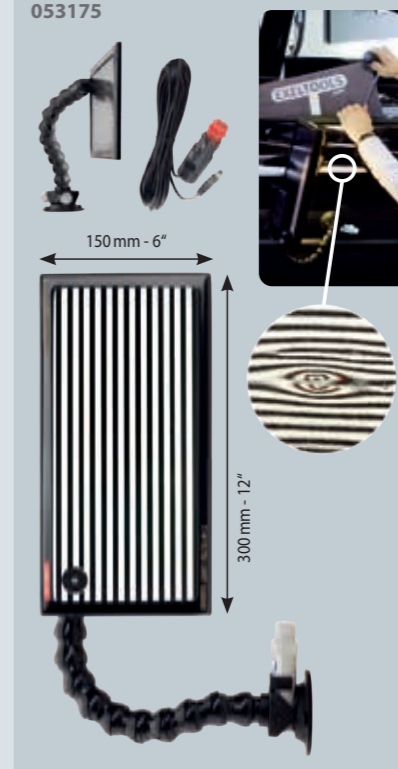

150 mm - 6"

300 mm - 12"

## PAINTLESS DENT REPAIR LAMPS

- Lampes de débosselage  
- Ausbeullampe

083936

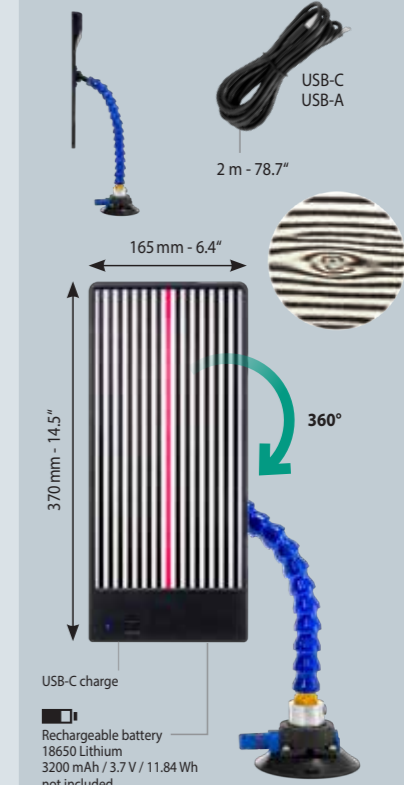

USB-C  
USB-A

2 m - 78.7"

165 mm - 6.4"

370 mm - 14.5"

360°

USB-C charge

Rechargeable battery

18650 Lithium

3200 mAh / 3.7 V / 11.84 Wh

not included

## SET OF 6 PENCIL PUNCHES

- Kit de 6 coins de frappe - Beulenstemmer-Satz mit 6 Tefloneinsätzen

052888

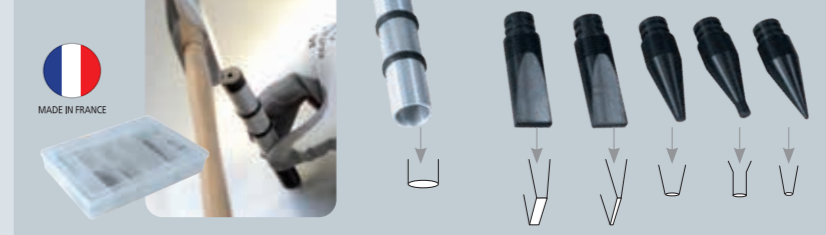

## PNEUMATIC INERTIA HAMMER

- Marteau inertie pneumatique - Unterdruck-Schlaghammer

051904

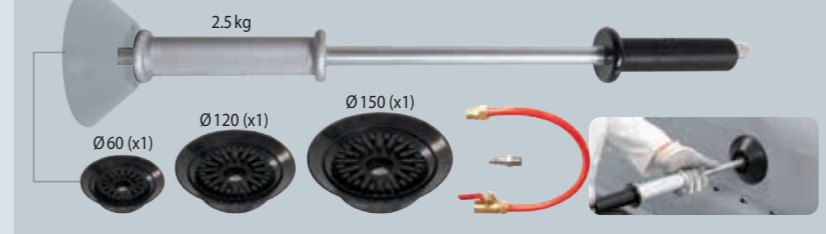

2.5 kg

Ø 60 (x1)

Ø 120 (x1)

Ø 150 (x1)

## PUMP AIR SUCTION SLIDE HAMMER

- Marteau à inertie à ventouses (pompage manuel) - Man. Unterdruck-Schlaghammer

1,1 kg

048683

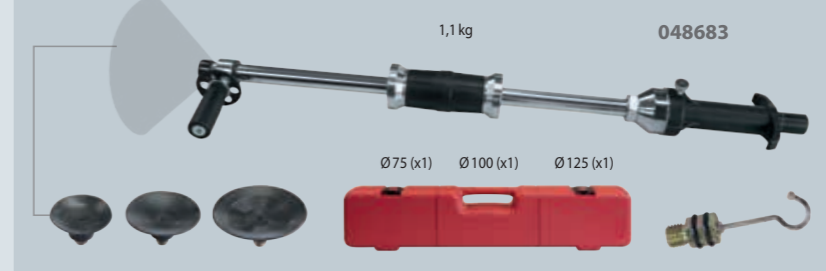

Ø 75 (x1)

Ø 100 (x1)

Ø 125 (x1)





PDR: Paintless Dent Repair  
- Débosselage rapide et sans peinture  
- Lackschadenfreies Ausbeulen

# PAINTLESS DENT REPAIR

## GLUE PULLER PRO (Acier/Alu • Steel/Alu)



Glue Puller PRO  
058699

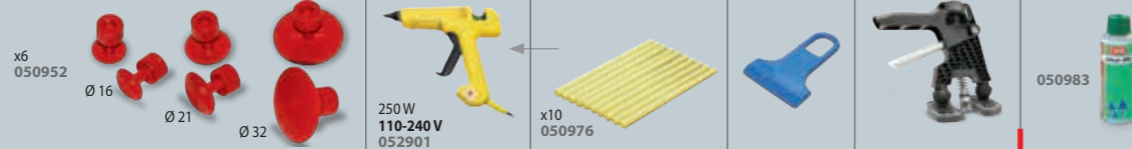

Glue Puller PRO EXPORT  
230 V 059160

## BARRETTES ANNEAUX PLASTIQUE - Plastic Multipads Ösen-Klebe pads

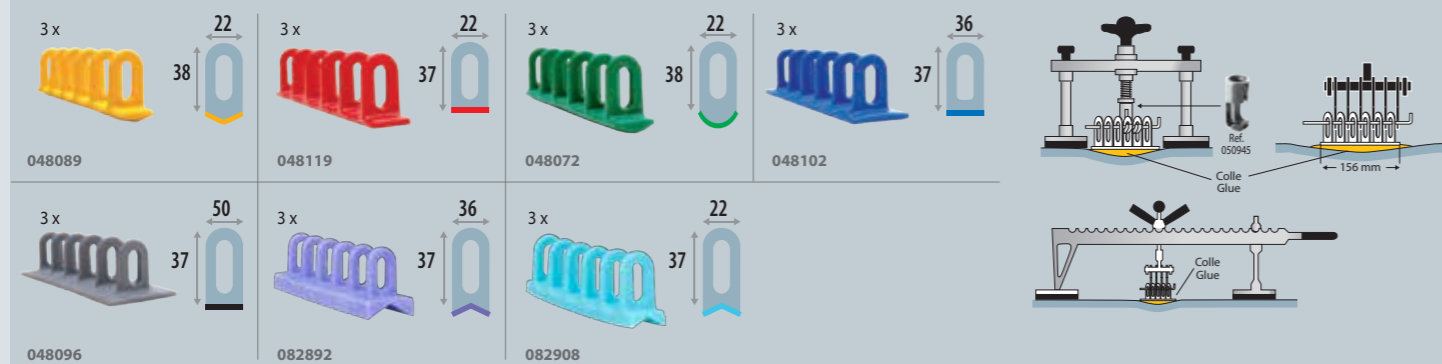

## OPTIONS

Pulling handle 3 claws - Poignée de tirage 3 dents - Handzugkralle 3-fach  
057326



Slide hammer 380 g  
- Marteau à inertie 380 g  
- Gleithammer 380 g

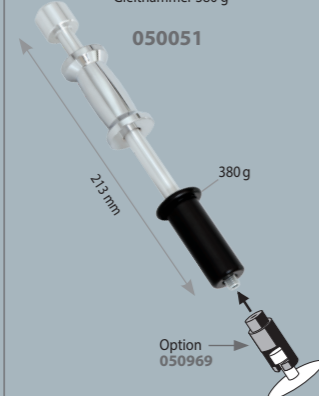

Slide hammer 500 g  
- Marteau à inertie 500 g  
- Gleithammer 500 g

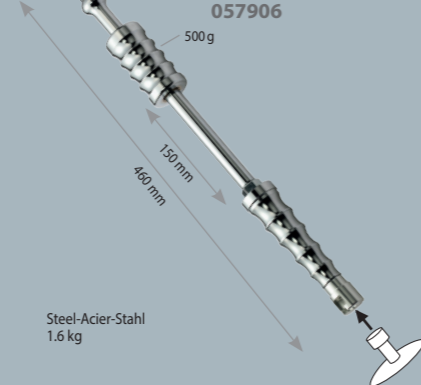

Set of 2 knives to cut glued reinforcements  
- Jeu de 2 couteaux pour découpe de renforts colles  
- 2-er Set Messer zur Klebepadentfernung



Workstation 054233	Set of pencil punches with 6 teflon tips 052888	Infrared thermometer 079922 Heat Gun 066311	Levelling bar 050693 6 Gripping multihook head 049734	3 Lifting rods 150/300/500 mm 050792	Set of 3 conical plastic multipads 048096 048072 048089 048119 048102	Slide hammer 057906	Set of 6 glue tips 050952	Glue Puller PRO 058699	Glue Puller PRO Export 059160	33PC Paintless dent repair kit 051959 PDR Light ultra light carbon X40PW 053175	Mini puller 050921 Aluminium clamp 2 050945
--------------------	---	--	--	--------------------------------------	---	---------------------	---------------------------	------------------------	-------------------------------	--	--

GYSMART GLUE PULLING KIT 076051					✓						
GYSMART GLUE PULLING KIT EXPORT 076105				✓					✓		
GYSMART GLUE PULLING KIT PLUS 076082					✓						✓
GYSMART GLUE PULLING KIT PLUS EXPORT 076129				✓						✓	





GPR: Glue Pulling Repair  
- Débosselage par colle  
- Lackschadenfreies Ausbeulen

# GLUE PULLING REPAIR



## GPR I-BAR MINI



080324



## GPR FLEXIBLE TABS

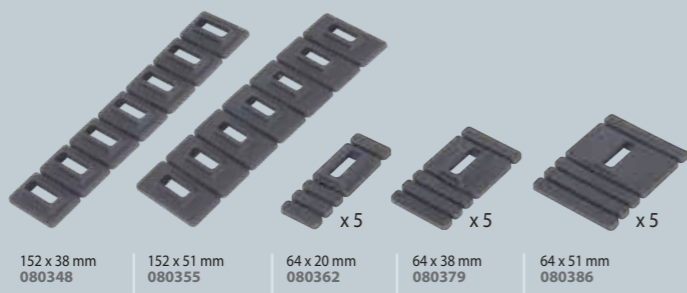

## GPR FLAT TABS



## GPR 3D TABS



## GPR 3D CURVE TABS

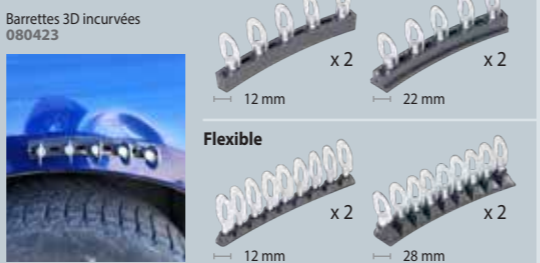

## GPR UNIVERSAL TABS

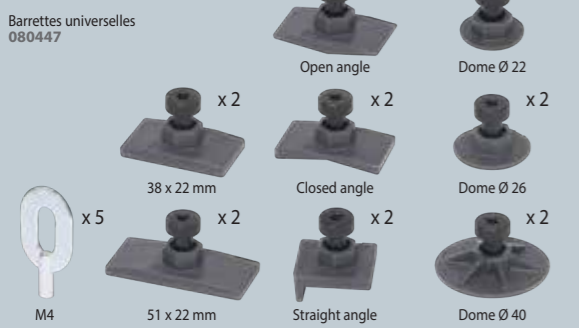

## GPR FOLD TABS

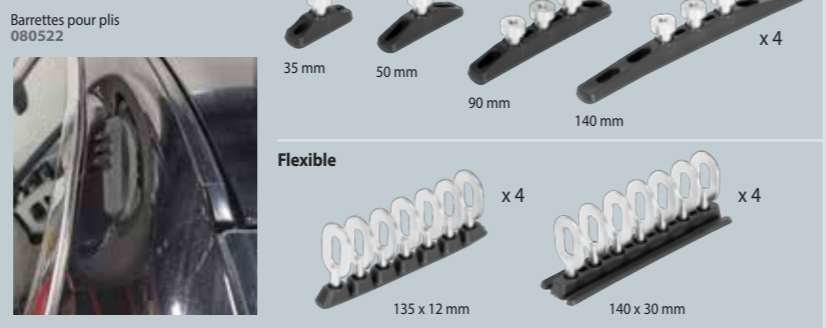

## GPR HAIL IMPACT TABS



## GPR BAR TABS

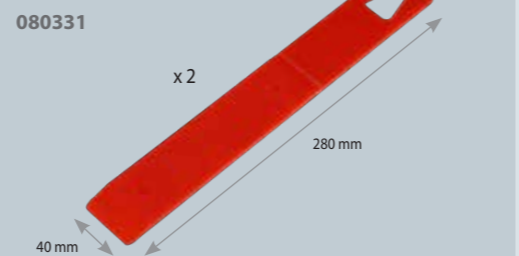

## GLUE GUN 400W - Pistolet à colle chaude 400W



## GPR PRO KIT



1	GPR I-bar mini	51 mm	x 1
<b>GPR Flexible tabs</b>			
2	64 x 20 mm		x 1
	64 x 38 mm		x 1
	64 x 51 mm		x 1
<b>GPR Long tabs</b>			
3	152 x 38 mm		x 1
	152 x 51 mm		x 1
<b>GPR Plastic hooks</b>			
4			x 10
<b>GPR Bar tab</b>			
5			x 1
<b>GPR 3D tabs</b>			
6	12 mm		x 1
	22 mm		x 1
<b>GPR 3D curved tabs</b>			
7	51 x 38 mm		x 1
	101 x 38 mm		x 1
<b>GPR M4 steel hooks</b>			
8			x 5
<b>GPR Universal tabs</b>			
	Flat 38 x 22 mm		x 1
	Flat 51 x 22 mm		x 1
9	Open angle 38 x 22 mm		x 1
	Closed angle 38 x 22 mm		x 1
	Straight angle 27 x 22 mm		x 1
	Dome Ø 22 mm		x 1
	Dome Ø 26 mm		x 1
	Dome Ø 40 mm		x 1
<b>GPR Flat tabs</b>			
	Ø 13 mm		x 1
	Ø 23 mm		x 1
10	Ø 27 mm		x 1
	Ø 32 mm		x 1
	Ø 38 mm		x 1
	Ø 52 mm		x 1
<b>GPR Bars for folds</b>			
	35 mm		x 1
	50 mm		x 1
	90 mm		x 1
	140 mm		x 1
	Flexible 135 mm		x 1
	140 x 30 mm		x 1
11	<b>GPR Glue sticks</b>		x 10
12			

**Isopropyl alcohol 99.9% + spray** - Alcool isopropyloque 99,9% + vaporisateur 082236

**Heat gun** - Décapeur thermique 066311

230 V only

Digital display - Affichage numérique

I: 100/300°C (450 W)  
II: 300/650°C (1500 W)  
Air flow: 450 l/min

1 L 600 ml

**Gas hot air gun** - Pistolet à air chaud autonome à gaz 060777

**Blow torch** - Lampe à souder 052741

Gas not included - Bouteille non incluse

**Novacet +** Butane/Propane/Propylène 040441

HIGH QUALITY

380 ml (220 g)

**Infrared thermometer** - Thermomètre infrarouge 079922

Adjustable emissivity: 0.10-1.00

-50~+600°C  
-58~+1112°F

Set of 6 pencil punches - Kit de 6 coins de frappe 052888

(p. 47)

**3 plastic wedges** - 3 cales plastiques 051294

**Lifting rod 180 mm** - Tige de tirage 180 mm 082915

**Pulling hand 3 claws** - Poignée de tirage 3 dents 057326

**Slide hammer 500g** - Marteau à inertie 500g 057906

**Slide hammer 1.7kg** - Marteau à inertie 1,7kg 051201

4 tooth claw Ø M10 / M14 049758

(p. 48)

**Glue Lifter** 057364

included 061392

(p. 48)

**Arc Puller Premium** 065161

included Alu 3 065161

included Alu 4 065185

option Steel M14 079830

(p. 19)

**Premium Pro Levelling bar 900 mm** 071643

(p. 22)

**Airfix Draw Aligner** 077379

(p. 39)





# RESISTANCE SPOT WELDING

RANGES	54
--------	----

## PRESENT MACHINES

PORTASPOT / 100 R.CX / B.P.LX	56
BP GENIUS	58
PTI-S7 / PTI PREMIUM PRO	60
PTI GENIUS	62

## NEW MACHINES WITH COLOUR SCREEN

PTI NEO	64
PTI MASTER / PTI EXPERT	66

## ARMS & CONSUMABLES

G ARMS	68
ACCESSORIES & CONSUMABLES	69
X ARMS / C ARMS	70









PORTASPOT / GYSPOT

# RESISTANCE SPOT WELDING

PORTASPOT 230

## 6 300 A 120 daN

Air cooled

230V  
022256

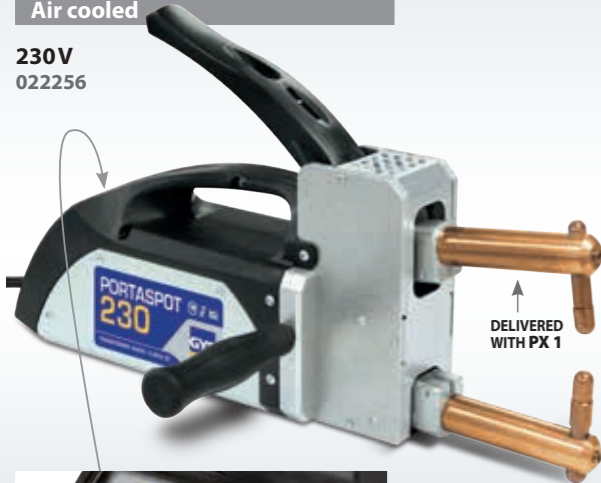

DELIVERED WITH PX 1



ARMS Ø 23 mm

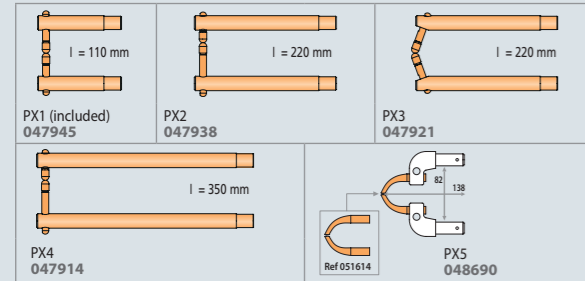

ELECTRODES

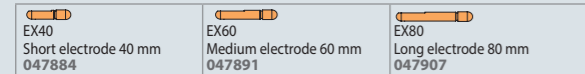

CAPS & ACCESSORIES

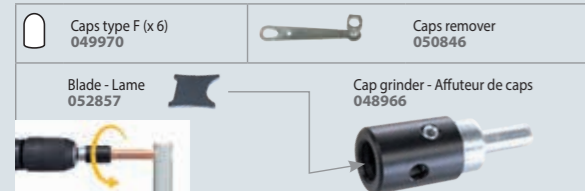

50/60 Hz	A	A	A	mm	V	mm	mm <sup>2</sup>	100% CU	LxWxH cm / kg
1 x 230V	16(D)	6 300	8 900	2+2	2.45	2.5	3x2.5 H05VVf	OK	41 x 18 x 22 / 11.3

## GYSPOT 100R-CX

### 10 000 A 550 daN (X) 350 daN (C)

For mild steel, HSS, UHSS

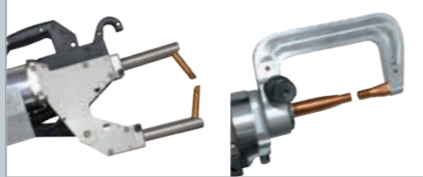

Air cooled

Traceability software  
Save spot welding configuration and export data



3 x 400V  
022317



OPTIONS 100R-CX

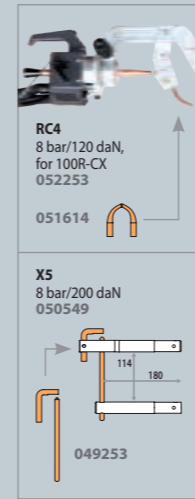

included	
Monopoint/Spot 049291	▪
Inertia hammer 049482 + 049802	▪
Spotter box pro 050075	▪
Top support box	▪
Contact grease 050440	▪
Caps remover 050846	▪
Cable support	× 2
RX1 051034	▪
RX3 051058	▪
RC1 051065	▪
RC2 051072	▪
RC3 051089	▪

OPTIONS



## GYSPOT BP-LX

### 13 000 A 550 daN

For mild steel, HSS, UHSS Boron steel



Liquid cooled

BP BODYPROTECT  
Unique electro-magnetic field protection  
2019/35/UE by GYS

Traceability software  
Save spot welding configuration and export data



019652

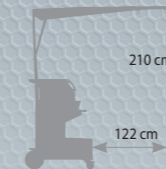

	019652	058804
Gyspot BP-LX	400V	
Monopoint/Spot 049291	▪	▪
Spotter box pro (p.10) 050075	▪	▪
Inertia hammer 049482 + 049802	▪	▪
X1 050501	▪	▪
X4A (x2) + X4B + X4C + X2 020733	▪	▪
Liquid cooling (10l) 052246		▪ (x3)

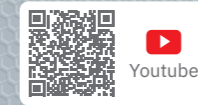

57

GYSPOT 100R / BP

AIR / LIQUID COOLED

MADE IN FRANCE 62135	50/60 Hz	A D curve	Spots/min (max) ± 2.5+2.5	RMS A	mm		Uo V	Cables				100% CU	LxWxH cm / kg
					↕	↔		↔	↔	↔	↔		
GYSPOT 100R.CX	3 x 400V	32 (22 kVA) 40 (28 kVA) 50 (35 kVA)	2 6 10	10 000	2.5+2.5+2.5	1.5+3	16	2.5 m, air Ø 200 mm <sup>2</sup>	2.5 m, air Ø 200 mm <sup>2</sup>	2.5 m, air Ø 150 mm <sup>2</sup>	8 m, 4 x 6 H07RNF	OK	61 x 79 x 71 / 137
GYSPOT BPLX	3 x 400V	32 (22 kVA) 40 (28 kVA) 50 (35 kVA)	2 6 10	13 000	2.5+2.5+2.5	1.5+3	16	2.5 m, liquid	—	2.5 m, air	8 m, 4 x 6 H07RNF	OK	65 x 80 x 205 / 164.5





GYSPOT

# RESITANCE SPOT WELDING BP GENIUS

**G**  
ARMS



MADE IN FRANCE

G-clamp front  
body + protection  
078765

**ULTRA LIGHT  
& COMPACT**  
6.5 kg  
(Gyro & G1 included)

550 daN

LIQUID COOLED  
REFROIDISSEMENT  
LIQUIDE  
Ø 10 mm

6.5 kg  
(Gyro & G1 included)



Youtube

## OPTIONS

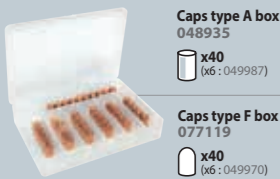

Caps type A box  
048935  
x40 (x6: 049987)  
Caps type F box  
077119  
x40 (x6: 049970)

x20 (x6: 049987)  
x6 (x6: 049970)  
x2 (x1: 050617)  
073449



Cooling liquid - Liquide  
de refroidissement  
- Kühlmittel  
- Enfriamento líquido  
- Refrigeração líquida

2L 082212  
5L 062511  
10L 052246



Protection  
cover  
- Housse de  
protection  
- Schutzhaube  
for BP & PTI  
050853



10-14 kg  
059696

## FAST OPEN XL

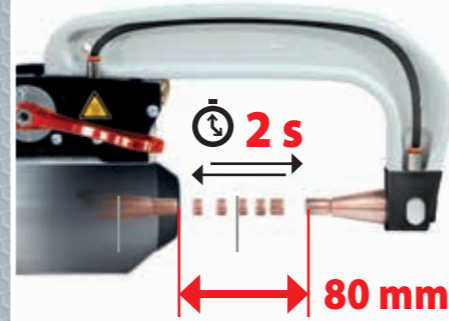

## EASY



## GYRO INTEGRATED



## PERFECT ELECTRICAL CONNECTION



## AUTO

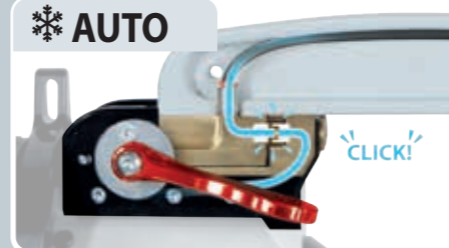

## GYSPOT BP GENIUS

13 000 A  
550 daN

For mild steel, HSS, UHSS Boron steel

**BP** BODYPROTECT  
Unique electro-magnetic field protection  
by GYS

Traceability software  
Save spot welding configuration  
and export data



	023550	023451	082250
Gyspot BP GENIUS	220V	400V	
Monopoint/Spot 049291	▪	▪	▪
Spotter box pro (p.10) 050075	▪	▪	▪
Inertia hammer 049482 + 049802	▪	▪	▪
Caps remover 050846	▪	▪	▪
Arm support	▪	▪	▪
G1 022768	▪	▪	▪
G2 + G3 + G4 022898	▪	▪	▪
Liquid cooling (10L) 052246	▪	▪	(x3)
Caps type A box 048935	▪	▪	▪
Protection cover 050853	▪	▪	▪



Included Protection 067271

120 cm

210 cm

80 cm

Included Cable support for BPLG ULTRA RESISTANT 059719

Gun & cable support



59

GYSPOT BP GENIUS

LIQUID COOLED

MADE IN FRANCE 62135	50/60 Hz	RMS A	-AM- A D curve	Spots max 2.5+2.5 mm	Uo V	mm			Cables			100% CU	cm	kg													
						↕	↔	↗	↘	↖	↙																
GYSPOT BP GENIUS 400V	3 x 400V	13 000	32 (22 kVA) 40 (28 kVA) 50 (35 kVA)	2 6 10	16	2.5+2.5+2.5	1.5+3	2.5 m, Ø 200 mm <sup>2</sup> , Liquid	2.5 m, Ø 150 mm <sup>2</sup> air	8 m 4x6 mm <sup>2</sup> H07RN-F	OK	65 x 80 x 205	171														
														GYSPOT BP GENIUS 220V	3 x	200V 10 500 208V 11 000 230V 12 000 240V 12 500	60 (21-25 kVA) 80 (28-33 kVA) 100 (35-41 kVA)	2 6 10	15 15.5 17 18	2.5+2.5+2.5	1.5+3	2.5 m, Ø 200 mm <sup>2</sup> , Liquid	2.5 m, Ø 150 mm <sup>2</sup> air	8 m 4x6AWG (500V)	OK	65 x 80 x 205	178





GYSPOT

# RESISTANCE SPOT WELDING

GYSPOT PTI-s7

**14 500 A**  
550 daN

For mild steel, HSS, UHSS Boron steel

- FUSE 20 A
- Double pressure
- Ø 10 mm
- 9.9 kg (included C1)

TRANSFORMER INSIDE

Liquid cooled

Traceability software  
Save spot welding configuration and export data

Convert PTI S-7 to Premium Pro  
C ARMS → G ARMS

Kit Renov PTI Premium Pro

220V 072367

400V 072541

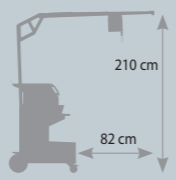

C ARMS



9.9 kg

	4M 020894	4M 067998
	6M 022195	6M 020900
	<b>220V</b>	
	<b>400V</b>	
Contact grease 050440	▪	▪
Caps remover 050846	▪	▪
Arm panel	▪	▪
C1 021402	▪	▪
C2 + C3 + C4 060821	▪	▪
C6 022409	▪	▪
Gyro 360° 051720	▪	▪
Complete gun kit 067318	▪	▪
Liquid cooling (10L) 052246		(x3)

### OPTIONS

**GYRO 360° for PTI S-7**  
051720

**Kit gun for PTI S-7**  
067318

200 mm<sup>2</sup>  
1.6 m

300 mm<sup>2</sup>  
1 m

**Cooling liquid - Liquide de refroidissement**  
- Kühlmittel  
- Enfriamiento líquido  
- Refrigeração líquida

2 L 082212  
5 L 062511  
10 L 052246

**Protection cover**  
- Housses de protection  
- Schutzhaube

for BP & PTI  
050853

10-14 kg  
059696

MADE IN FRANCE 62135	50/60 Hz	RMS A	S RMS A D curve	Spots/min (max)	U <sub>o</sub>		mm		Cables			cm	kg
					V	mm	mm	mm	mm	mm			
<b>GYSPOT PTI-s7</b>	3 x 400 V	<b>14 500</b>	<b>20</b> (14 kVA)	<b>10</b>	7.3	2.5+2.5+2.5	1.5+3	4 m, liquid or 6 m, liquid	OPTION 067318 : 1.6 m, Ø 200 mm <sup>2</sup>	8 m, 4x4 mm <sup>2</sup> H07RNF	65 x 80 x 230	105.3	
<b>GYSPOT PTI-s7 220 V</b>	3 x	200 V <b>12 500</b>	<b>40</b> (14-16 kVA)	<b>10</b>	6.5	2.5+2.5+2.5	1.5+3	4 m, liquid or 6 m, liquid	OPTION 067318 : 1.6 m, Ø 200 mm <sup>2</sup>	8 m, 4xAWG8 (500W)	65 x 80 x 230	115.7	
208 V <b>13 000</b>		6.7											
230 V <b>14 500</b>		7.4											
240 V <b>14 500</b>		7.7											

## GYSPOT PTI PREMIUM PRO

**14500 A**  
550 daN

For mild steel, HSS, UHSS Boron steel

- FUSE 25 A
- Double pressure
- Ø 10 mm
- 10.3 kg (included G1)

TRANSFORMER INSIDE

Liquid cooled

Traceability software  
Save spot welding configuration and export data

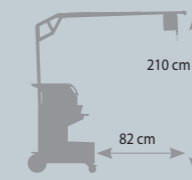
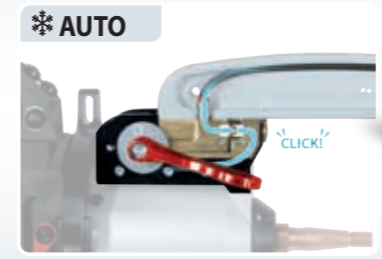

G ARMS



10.3 kg

	6M 072206	6M 072183	6M 082243
Caps remover 050846	▪	▪	▪
Arm panel	▪	▪	▪
G1 022768	▪	▪	▪
G2 + G3 + G4 022898	▪	▪	▪
Liquid cooling (10L) 052246			(x3)
Caps type A box 048935	▪	▪	▪
Protection cover 050853	▪	▪	▪

### OPTIONS

**Kit gun for PTI Premium Pro**  
067226

300 mm<sup>2</sup>  
1.8 m

300 mm<sup>2</sup>  
1 m

**G11 for PTI Premium Pro**  
071766

25 mm max  
120 mm

MADE IN FRANCE 62135	50/60 Hz	RMS A	S RMS A D curve	Spots/min (max)	U <sub>o</sub>		mm		Cables			cm	kg
					V	mm	mm	mm	mm	mm			
<b>GYSPOT PTI PREMIUM PRO 400V</b>	3 x 400 V	<b>14 500</b>	<b>25</b> (14 kVA)	<b>10</b>	7.4	2.5+2.0+2.0	1.5+3.0	6 m, liquid	OPTION 067226 : 1.8 m, Ø 300 mm <sup>2</sup>	8 m, 4x4 mm <sup>2</sup> H07RNF	65 x 100 x 230	109	
<b>GYSPOT PTI PREMIUM PRO 220V</b>	3 x	200 V <b>12 500</b>	<b>50</b> (17-21 kVA)	<b>10</b>	6.5	2.5+2.0+2.0	1.5+3.0	6 m, liquid	OPTION 067226 : 1.8 m, Ø 300 mm <sup>2</sup>	8 m, 4xAWG8 (500W)	65 x 100 x 230	119	
208 V <b>13 000</b>		6.7											
230 V <b>14 500</b>		7.4											
240 V <b>14 500</b>		7.7											







GYSPOT

# RESISTANCE SPOT WELDING PTI GENIUS



MADE IN FRANCE

550 daN

LIQUID COOLED  
REFROIDISSEMENT  
LIQUIDE  
Ø 10 mm

11.3 kg  
(Gyro & G1 included)

TRANSFORMER  
INSIDE



G  
ARMS

G-clamp front  
body + protection  
078765

Control command  
- Contrôle de commande

Motorised cable support  
- Potence électrique  
- Elektrisch verstellbarer  
Kabelsupport

UP  
253  
cm

DOWN  
159  
cm

UPSIDE  
DOWN  
POSITION

FAST OPEN XL

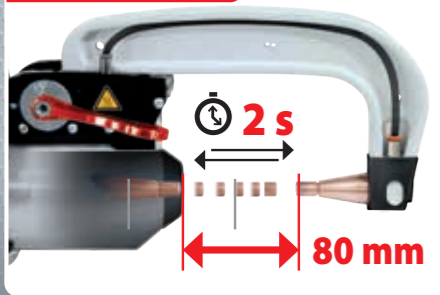

GYRO INTEGRATED

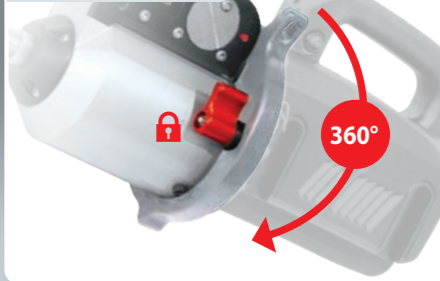

PERFECT ELECTRICAL CONNECTION

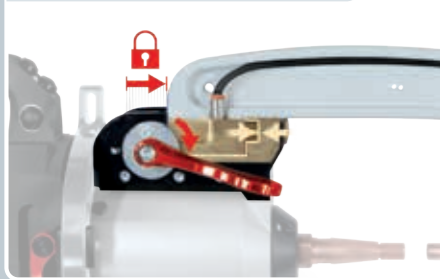

AUTO

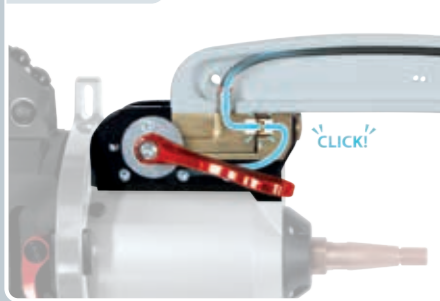

OPTIONS

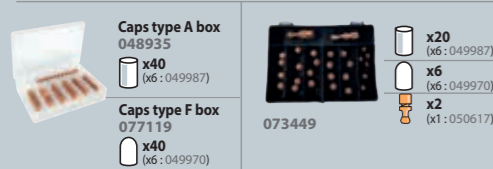

GYSPOT  
PTI GENIUS

14 500 A  
550 daN

For mild steel, HSS, UHSS Boron steel

TRANSFORMER INSIDE

Liquid cooled

Traceability software  
Save spot welding configuration  
and export data

	024878	082267	024854	024892
	400V		220V	480V
Gyspot PTI-GENIUS				
Caps remover 050846	▪	▪	▪	▪
Arm support	▪	▪	▪	▪
G1 022768	▪	▪	▪	▪
G2 + G3 + G4 022898	▪	▪	▪	▪
Liquid cooling (10L) 052246		(x3)		
Caps type A box 048935		▪		
Protection cover 077126		▪		

Ergonomic

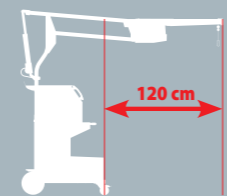

Included  
Cable support  
ULTRA  
RESISTANT



Control  
Commande



Electrode storage  
- Rangement pour  
électrodes

ELECTRIC  
MOTOR

6 m

High stability -  
Grande stabilité

OPTIONS



MADE IN FRANCE 62135	50/60 Hz	RMS A	-AM- A D curve	Spots/min (max)	Uo V	mm		Cables		cm	kg		
						↕	↔	↕	↔				
GYSPOT PTI GENIUS 400V	3 x 400V	14 500	25 (17 kVA)	20	7	2.5+2.5+2.5	1,5 + 3	6 m, Liquid	8 m 4x4 mm <sup>2</sup> H07RN-F	71 x 90 x 200	127.7		
												200	12 500
												208	13 000
												230	14 500
GYSPOT PTI GENIUS 220 V	3 x	14 500	50 (17-21 kVA)	20	7.3	2.5+2.5+2.5	1,5 + 3	6 m, Liquid	8 m 4xAWG8 (500W)	71 x 90 x 200	136.2		
												240	14 500
												7.9	
GYSPOT PTI GENIUS 480V	3 x 480V	14 500	20 (17 kVA)	20	7	2.5+2.5+2.5	1,5 + 3	6 m, Liquid	8 m 4xAWG12 (500W)	71 x 90 x 200	128.7		



63

GYSPOT PTI GENIUS

LIQUID COOLED



# RESISTANCE SPOT WELDING PTI NEO

NEW



MADE IN FRANCE

### Manual Mode

Direct entry of welding current, time and pressure -  
Entrée directe du courant et temps de soudage et de la pression

3.5" colour screen  
Easy navigation interface



Traceability software  
Save spot welding configuration and export data



### Automatic Mode

Automatic detection of the welding parameters  
- Détection automatique des paramètres de soudage



### Synergic Mode

User defined welding parameters  
- Programmation par l'utilisateur



### Car Manufacturer Mode

Specific Car Manufacturer pre-programmed welding parameters  
- Points de soudure constructeur préprogrammés



G ARMS

### EASY OPENING

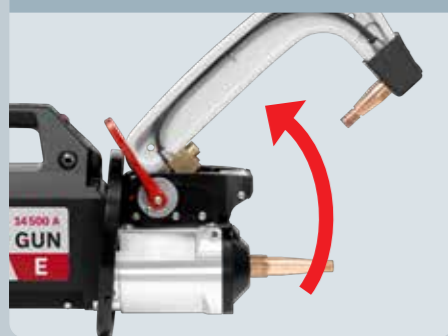

### PERFECT ELECTRICAL CONNECTION



### AUTOMATIC HYDRAULIC CONNECTION



### OPTIONS



Caps type A box  
048935  
x40 (x6: 049987)  
Caps type F box  
077119  
x40 (x6: 049970)



x20 (x6: 049987)  
x6 (x6: 049970)  
x2 (x1: 050617)  
073449



EASY USB UPDATE  
USB key 16 Gb  
062344

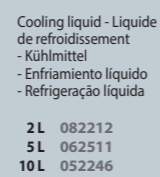

Cooling liquid - Liquide de refroidissement  
- Kühlmittel  
- Enfriamiento líquido  
- Refrigeração líquida  
2L 082212  
5L 062511  
10L 052246

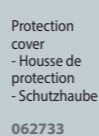

Protection cover  
- Housse de protection  
- Schutzhaube  
062733



## GYSPOT PTI NEO

13000 A  
550 daN

For mild steel, HSS, UHSS Boron steel

TRANSFORMER INSIDE

Liquid cooled : 5 litres

### Automatic Mode

Automatic detection of the welding parameters

### 3.5" colour screen

Easy navigation interface

### Traceability software

Save spot welding configuration and export data

	024779	084834	077362	084841
Gyspot PTI-NEO	400V		208-240V	
Caps remover 050846	■	■	■	■
G1 022768	■	■	■	■
G2 + G4	■	■	■	■
	ALL IN 1 BOX	ALL IN 1 BOX	ALL IN 1 BOX	ALL IN 1 BOX

78.5 x 58.5 x 64 cm  
6 units/palette

### G arms storage



G1, G2, G3 storage

### OPTION

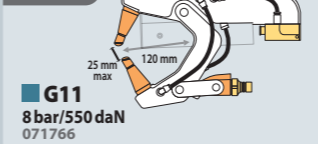

G11  
8 bar/550 daN  
071766

G ARMS



9.7 kg  
VERY LIGHT

### OPTION

QUICK FIX Single sided gun  
- Kit Pistolet monopoint  
082823



EASY CONNECTION



HSS  
UHSS  
Boron

NEW  
05/2024



4 m

LIQUID COOLING  
5 Litres

MADE IN FRANCE 62135	50/60 Hz	RMS A	TAM A D curve	Spots/min (max)	Uo V	mm		Cables				cm	kg	
						mm	mm	(option)	(option)	(option)	(option)			
GYSPOT PTI NEO 400V	3 x 400V	13 000	20	10	7.7	2.5+2.0+2.0	1.5+3.0	4 m, Liquid	1.8 m, Ø 300 mm <sup>2</sup>	1 m, Ø 300 mm <sup>2</sup>	8 m 4x4 mm <sup>2</sup> HOT8NF	63 x 76 x 127	57	
														6.7
														6.9
														7.7
GYSPOT PTI NEO 208-240V	3 x 208V 230V 240V	10 900 11 300 12 500 13 000	30	10	7.7 6.9 7.7 8	2.5+2.0+2.0	1.5+3.0	4 m, Liquid	1.8 m, Ø 300 mm <sup>2</sup>	1 m, Ø 300 mm <sup>2</sup>	8 m 4xAWG8 (SOOW)	63 x 76 x 127	62	
														6.7
														6.9
														7.7





GYSPOT

RESISTANCE SPOT WELDING

# PTI MASTER PTI EXPERT



MADE IN FRANCE

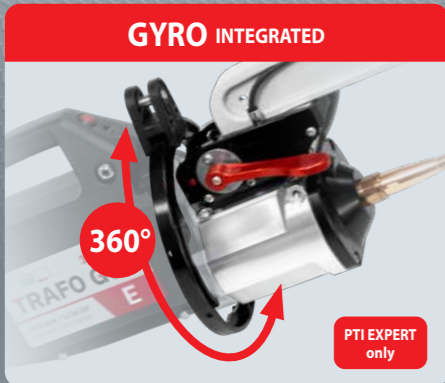
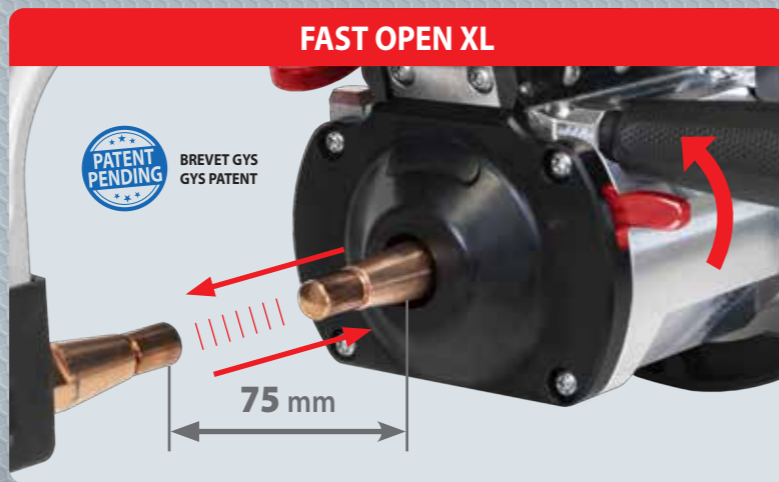

## TRANSFORMER INSIDE

MASTER 10.3 kg  
(G1 included)

EXPERT 11.8 kg  
(Gyro + G1 included)

**LIQUID COOLED**  
Refróidissement liquide

### OPTIONS

G-clamp front body + protection 078765



QUICK FIX Single sided gun - Kit Pistolet monopoint 082823

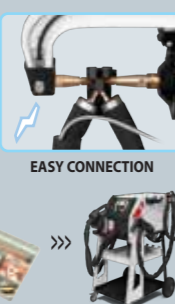

Cooling liquid - Liquide de refroidissement - Kühlmittel - Enfriamiento líquido - Refrigeração líquida



Protection cover for PTI MASTER 062733



Protection cover for PTI EXPERT 050853



10-14 kg  
059696

**TRANSFORMER INSIDE** For mild steel, HSS, UHSS Boron steel

**Automatic Mode**

**3.5" colour screen**

**Traceability software**

**GYSPOT PTI MASTER**

**13000 A**  
550 daN

Liquid cooled : 5 litres

**GYSPOT PTI MASTER 400V**

**13 000 A** 400V • 3 phase

083264

**GYSPOT PTI MASTER 208-240V**

**13 000 A** 208-240V • 3 phase

083257

**GYSPOT PTI EXPERT**

**14500 A**  
550 daN

Liquid cooled : 30 litres

**GYSPOT PTI EXPERT 400V**

**14 500 A** 400V • 3 phase

083943

**GYSPOT PTI EXPERT 208-240V**

**14 500 A** 208-240V • 3 phase

083950



Country	Voltage	RMS A	A D curve	Spots/min (max)	Uo V	mm		Cables				cm	kg				
						mm	mm	(option)	(option)	(option)	(option)						
MADE IN FRANCE	3 x 400 V	13 000	20	10	7.7	2.5+2.0+2.0	1.5 + 3.0	4 m, Liquid	1.8 m, Ø 300 mm <sup>2</sup>	1 m, Ø 300 mm <sup>2</sup>	8 m, 4x4 mm <sup>2</sup> H07RNF	63 x 76 x 127	58				
														200 V	10 900	6.7	
														208 V	11 300		6.9
														230 V	12 500		
240 V	13 000	8															
Japan, USA, Brazil, Italy	3 x 208-240 V		13 000	30	10	7.7	2.5+2.0+2.0	1.5 + 3.0	4 m, Liquid	1.8 m, Ø 300 mm <sup>2</sup>	1 m, Ø 300 mm <sup>2</sup>	8 m, 4xAWG8 (500W)	63 x 76 x 127	63			
															200 V	12 500	6.5
															208 V	13 000	
		230 V													14 500	7.4	
240 V	14 500	7.7															
Japan, USA, Brazil, Italy	3 x 400 V		14 500	25	10	7.4	2.5+2.0+2.0	1.5 + 3.0	5 m, Liquid	1.8 m, Ø 300 mm <sup>2</sup>	1 m, Ø 300 mm <sup>2</sup>	8 m, 4x4 mm <sup>2</sup> H07RNF	65 x 100 x 230	109			
															200 V		12 500
															208 V	13 000	6.7
		230 V													14 500	7.4	
240 V	14 500	7.7															

GYSPOT  
67  
PTI MASTER / EXPERT  
LIQUID COOLED



FOR GYSPOT BP GENIUS, PTI PREMIUM PRO & PTI GENIUS

G Arms - Caps Ø13 mm

Bras isolés - Isolated arms - Isolierte Bügel

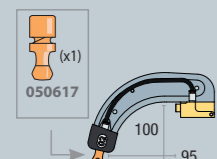
**G2**  
 8 bar/300 daN  
 022775

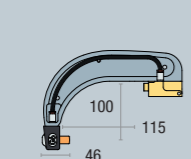

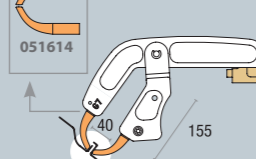
**G6**  
 8 bar/550 daN  
 022812

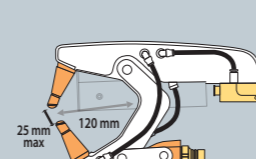

**G7**  
 4 bar/150 daN  
 022829

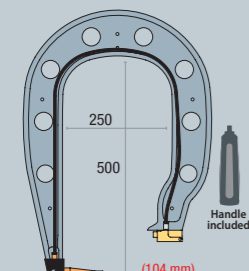

**G11**  
 8 bar/550 daN  
 for PTI PREMIUM PRO, NEO,  
 MASTER & EXPERT  
 071766

Kit de maintenance  
 connecteurs pince G -  
 Connectors maintenance  
 kit for G clamp  
 067295

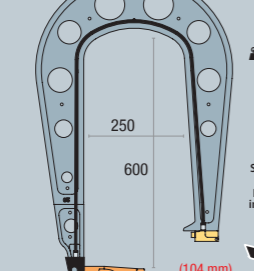
G arms protections  
 067288

**G4**  
 8 bar/550 daN  
 022799  
 Option for G4

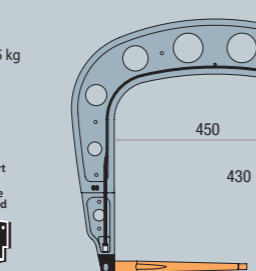
**G5**  
 8 bar/550 daN  
 022805  
 Option for G5

**G8**  
 8 bar/550 daN  
 022836  
 Option for G8

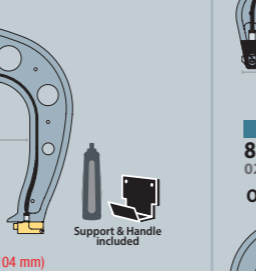
**G1**  
 8 bar/550 daN  
 022768  
 Option for G1 & G3

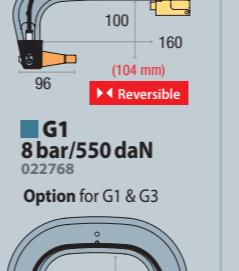

**G3**  
 8 bar/550 daN  
 022782

**G4-SA (Small Access)**  
 064478  
 (for arms < 01/2021)

**G5/G10-SA (Small Access)**  
 067660

**G8-SA (Small Access)**  
 067677

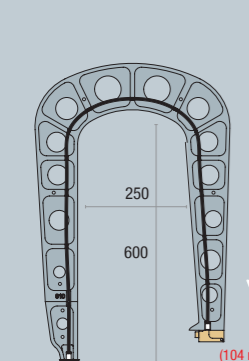
**G1/G3-SA (Small Access)**  
 067653  
 (for arms > 02/2021)

**G10**  
 8 bar/400 daN  
 067165  
 5 kg  
 20% saved

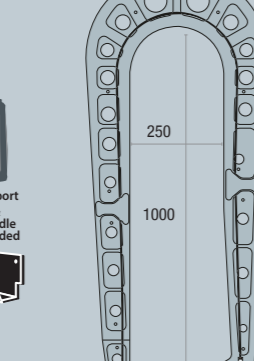
**G12**  
 8 bar/300 daN  
 075238

**G5/G10/G12-SA (Small Access)**  
 067660

**G X**  
 UNIQUE SYSTEM  
 AUTOMATIC WELDING  
 FOR X1, X2 & X6  
 BREVETÉ / PATENTED  
 n° US 11,618,097

**G9 | 8 bar/550 daN**  
 not for PTI PREMIUM PRO

**G9 with X1 Included**  
 022881

**X1**  
 050501  
 550 daN

**X2**  
 050518  
 300 daN

**G9 with X6 Included**  
 072275

**X6**  
 050587  
 300 daN

Option SD card 050914  
 Option PCB 97449C

**G ARMS PANELS**

G2  
 + G3  
 + G4  
 022898

G2  
 + G3  
 + G5  
 063297

**KIT SMALL ACCESS GENIUS** for PTI GENIUS 077072

included SA 073579  
 + G1/G3-SA (Small Access) 134  
 + G4-SA (Small Access) 156  
 + G5/G10/G12-SA (Small Access) 220  
 + G8-SA (Small Access) 368

**X/C/G CONSUMABLES - Consommables X/C/G**

Type A Cor X clamp Ø 13 mm (x6) 049987  
 Type B Cor X clamp Ø 13 mm / Ø 5 mm (x6) 055506  
 Type D Cor X clamp Ø 13 mm (x10) 058507  
 TYPE F For single sided gun Ø 13 mm (x6) 049970  
 TYPE G Ø 13 mm (x10) 059672  
 Caps inclinés - Beveled X2, X4C11 arms Ø 13 mm (x6) 049994  
 Caps type A box 048935 x40  
 Caps type F box 077119 x40  
 Contact grease Graise contact 050440  
 Caps remover 050846  
 Anti-corrosion welding primer - Primaire de soudage anti-corrosion 076822  
 Spot / Monopoint 049291

073449 x20  
 050068 x10  
 x6  
 x18  
 x18

**CAP GRINDER - Affuteur de caps**

048966  
 Youtube  
 Optimal speed: 400-800 rpm

**GYRO 360°**

for PTI 051720

**STEEL SHEET TRACTION BENCH**  
- Banc de traction arrache tôle - Blech-Zugbank zur Festigkeitsprüfung

052420

052321 (included)

**WELD TEST KIT - Valise test soudure HLE / THLE**  
- Schweißtestkit im Hartschalenkoffer

050433

Barre d'arrache / Traction bar  
 + Acier doux / Mild steel 0.65 (x25) + 1.0 (x25)  
 + Acier HSLA 360 - HLE 0.8 (x25) + 1.5 (x25)  
 + Acier DP600 - THLE/UHLE 1.0 (x25)  
 + Acier FB560 - THLE/UHLE 2.5 (x25)

**ANTI-ARC PROTECTION 12V**  
- Protection anti-arc 12 V  
- Lichtbogenschutz 12V - Protección anti-arco 12V

041318

**PROTECTION COVER**  
- Housses de protection  
- Schutzhaube

050853 for BP & PTI  
077126 for PTI GENIUS

**SHEETS SET**  
- Echantillons de tôles

Acier standard / Standard steel  
 0.8 (x65) + 1 (x55) + 1.5 (x35) + 2 (x25)  
 + Alu  
 1 (x45) + 1.5 (x30) + 2 (x20)  
 055841

**ELECTRODE FORCE SENSOR**  
- Capteur d'effort

052314

**TANK DRAINING KIT** - Kit de purge réservoir - Kit zur Tankentleerung

058286 for GYSPOT PTI-s7

**SD MEMORY CARD**  
- Carte mémoire SD

SD CARD 050914

**KIT WIFI**

for Gyspot Inverter PTI GENIUS 070691

**COOLING LIQUID**  
- Liquide de refroidissement  
- Kühlmittel - Enfriamiento líquido - Refrigeração líquida

2 L 082212  
 5 L 062511  
 10 L 052246



**FOR GYSPOT 32D-X, 100R-CX, BP-LX****550 daN****6,5 kg** including X1

- DOUBLE PRESSURE
- LIQUID COOLED / REFRIGÉRATION LIQUIDE
- Ø 10 mm

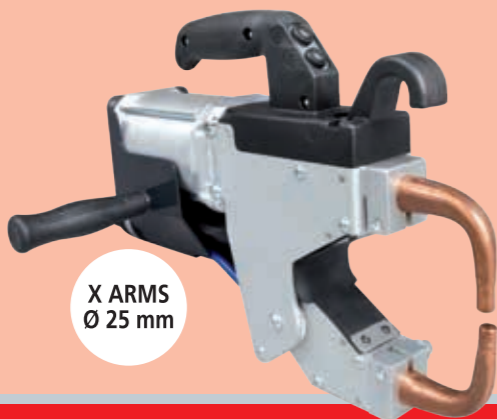
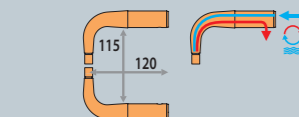
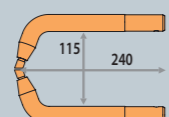
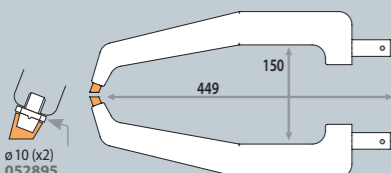
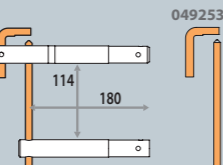
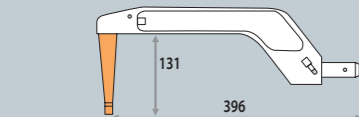
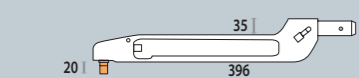
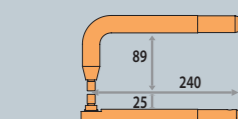

MADE IN FRANCE

**X ARMS**  
Ø 25 mm**X Arms - Caps Ø13 mm****X1 8 bar/550 daN**  
050501**X2 8 bar/400 daN**  
050518**X4 8 bar/120 daN**  
050532**X5 8 bar/200 daN**  
050549**X4A 8 bar/150 daN**  
020702**X4B 8 bar/150 daN**  
020719**X4C 8 bar/150 daN**  
020726**X6 8 bar/400 daN**  
050587**X4 (A, B & C) combinations**

X4A + X4A



X4A + X4B



X4B + X4B



X4A + X4C



X4C + X4C

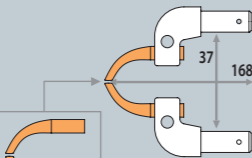
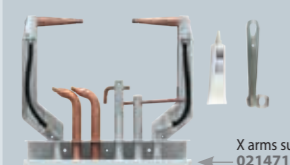
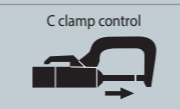
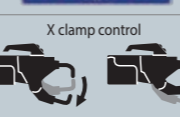

X4B + X4C

**X11 3 bar/150 daN**  
051607**X ARMS PANELS****X4A (x2) + X5 + X2**  
022324X arms support  
021471**X4A (x2) + X4B + X4C + X2**  
020733X arms support  
021471**Remote control (BP)**Digital screen control  
Change Mode & Parameters**C ARMS PANELS**C2 + C3 + C4  
**ALL IN 1 BOX**  
060821C10 + C3 + C5 + C6 + C9  
= 076495**FOR GYSPOT PTI****550 daN****Transformer inside****9,9 kg** including C1

- DOUBLE PRESSURE
- AIR COOLED + LIQUID COOLED / DOUBLE REFRIGÉRATION AIR + LIQUIDE
- Ø 10 mm

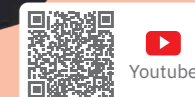
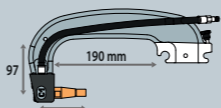
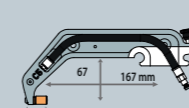
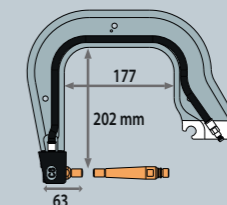
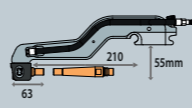
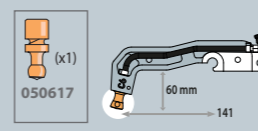
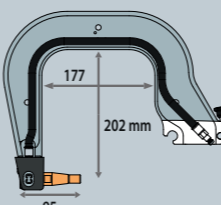
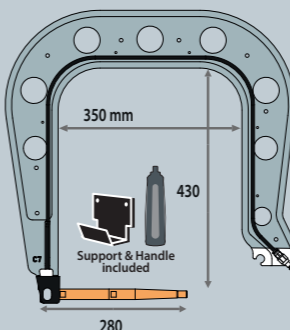
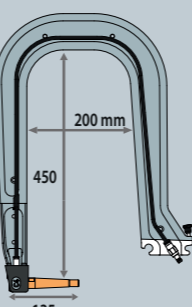
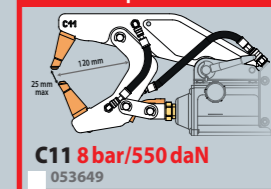
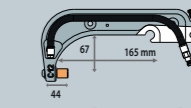
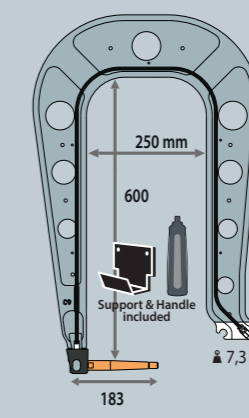
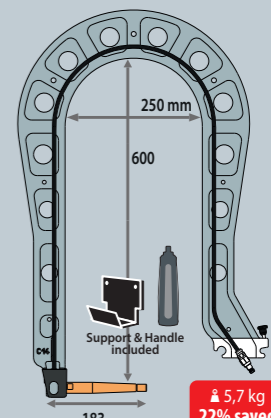
**C Arms - Caps Ø13 mm****Bras isolés - Isolated arms - Isolierte Bügel****ELECTRICAL INSULATION****C1 8 bar/550 daN**  
021402**C5 8 bar/550 daN**  
022393**C8 8 bar/550 daN**  
021440**C2 8 bar/550 daN**  
022386**C6 8 bar/300 daN**  
022409**C3 8 bar/550 daN**  
021419**C7 8 bar/550 daN**  
021433**C4 8 bar/550 daN**  
021426PTI arm support kit  
077577BP arm support kit  
080089Arm lock pin  
062405**X Arms - Caps Ø13 mm****X11 3 bar/150 daN**  
053649**C12 8 bar/550 daN**  
022997**C9 8 bar/550 daN**  
020078**C14 8 bar/400 daN**  
0235435,7 kg  
22% saved**Option for C7****C7-SA (Small Access)**  
067684

63 318

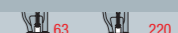
**Option for C9 & C14****C9/C14-SA (Small Access)**  
067660

63 220





GYSPRESS



**GYSPRESS 10T**

6.5 bar 100 kN

**10t**

063303

070653

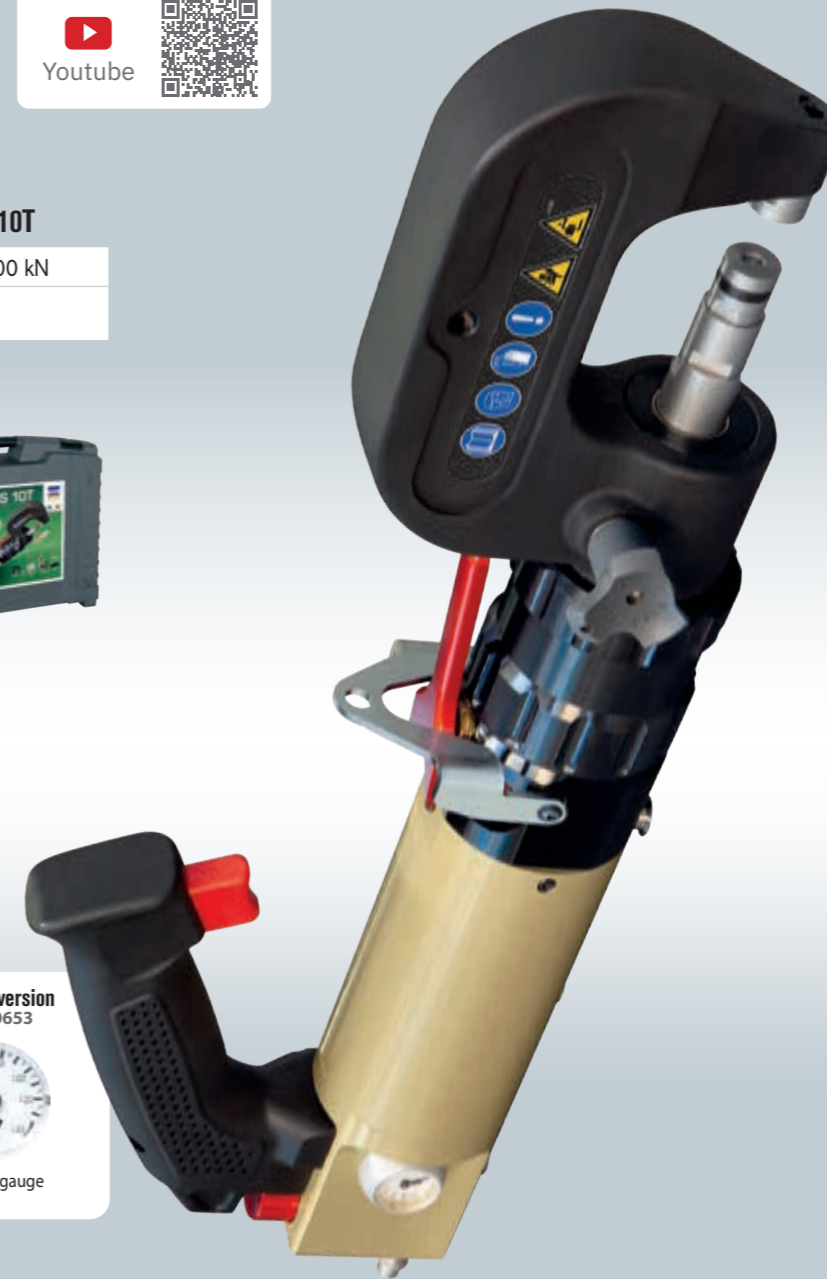

**US version**  
070653



Pressure gauge  
Psi



Discharge lever  
- Levier de décharge - Auslösehebel



Speed control - Contrôle de la vitesse - Regelung  
Werkzeuggeschwindigkeit



Pressure control  
- Contrôle de la pression - Druckregelung



# RIVETING

GYSPRESS 10T	73
GYSPRESS PREMIUM 10T PP	75
WORKSTATION	76
ADAPTERS	78
DIES BOXES & RIVETS	80
ACCESSORIES	83

**GYSPRESS 10T COMPLETE PACKS**

<b>GYSPRESS 10T</b> 063303 070653	✓						
<b>GYSPRESS 10T pack 1</b> 066441			✓				
<b>GYSPRESS 10T pack 2</b> 082991				✓			
<b>GYSPRESS 10T pack 3</b> 064744							✓

 MADE IN FRANCE	AIR BAR	PRESSURE CONTROL	SPEED CONTROL			
				cm	kg	LxWxH cm / kg
<b>GYSPRESS 10T</b>	6.5 bar = 10 t (maxi 10 bar)	0 > 6.5 bar		39.5 x 180	6.2 (HR110 included)	58 x 50 x 15 / 12.1





	HR110	HR210	HR310
	063310	063327	063334
GYSPRESS 8T	✓	✓	—
GYSPRESS 10T	✓	✓	✓
GYSPRESS 8T PUSH PULL	✓	✓	✓
GYSPRESS PREMIUM 10T PUSH PULL	✓	✓	✓
GYSPRESS 10T PUSH PULL	✓	✓	✓
GYSPRESS 10T CONNECT	✓	✓	✓



KIT WITH HR210 + HR310 064089

XT31-40 Rallonges bras HR310 pour point milieu - HR310 arm extension for middle point

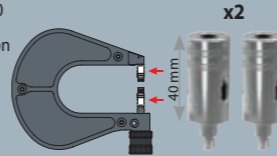

Compatible 8T PP/10T/10T PP x2

066335

OPTIONS

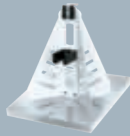

Riveting machine support for changing accessories (arms & dies)  
- Support Riveteuse pour changements d'accessoires (bras & matrice)  
- Supportständer

↳ 28 x 40 x 21,5 cm  
↳ 45 x 39 x 20 cm / 7,2 kg

054158



Trolley - Chariot

↳ 74 x 51 x 81 cm  
↳ 80 x 123 x 15 cm / 44 kg

054233

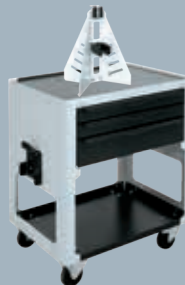

Trolley + Support Chariot + Support

↳ 51 x 74 x 122 cm  
↳ 51,2 kg

055391



Pressure sensor - Capteur d'effort 062115



Hydraulic body wrenches (x2) 067325



Temporary - Serre-tôles - fasteners manual mounting

- (x10) Ø 2,4 mm 069664
- (x10) Ø 4,0 mm 069671
- (x10) Ø 4,8 mm 069688
- (x10) Ø 6,4 mm 069695

GYSPRESS 10T PREMIUM PUSH PULL COMPLETE PACKS

	HR110 063310	XT11.21 - Extension for HR110 & HR210 058644	Standard 10T tool box 058631	6 x 50 rivets RAP - Nieten SPR 048706	HR210 + HR310 064089	24kN adapter 063822	Trolley+support 055391
GYSPRESS 10T PREMIUM PUSH PULL 077065	✓						
GYSPRESS 10T PPP pack 1 082519					✓		
GYSPRESS 10T PPP pack 2 082526							✓
GYSPRESS 10T PPP pack 3 082533							✓



GYSPRESS

PREMIUM PUSH PULL

GYSPRESS PREMIUM 10T PUSH PULL

6.5 bar 100 kN

10t

077065

070660



UNIQUE PUSH PULL SYSTEM by GYS

AUTO or MANUAL



LARGE OPENING

MORE ACCESS

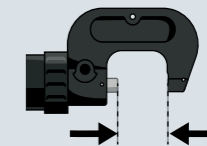

48.5 mm (no dies)  
23.5 mm with B1/B2 dies

ERGONOMIC WITH QUICK SELECTION

WORK FASTER



Push/Pull selection - Sélection Push/Pull

MANUAL PULL MODE



Manual/Automatic selection - Sélection Manuel/Automatique

OPENING CONTROL

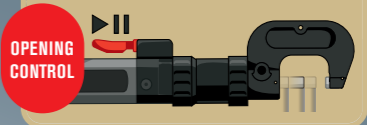

Pressure control - Contrôle de la pression - Druckregelung

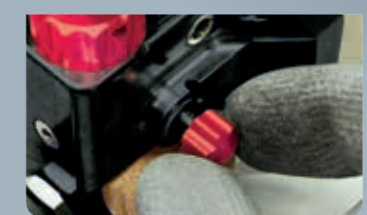

Speed control - Contrôle de la vitesse - Regelung Werkzeuggeschwindigkeit

US version 070660



Pressure gauge Psi



UNIQUE 100% No air inclusion maintenance free, no oil refill

MADE IN FRANCE	AIR BAR	PRESSURE CONTROL	SPEED CONTROL	↕	⚖	⚖
				cm	kg	kg
GYSPRESS 10T PREMIUM PUSH PULL	6.5 bar = 10 t (maxi 10 bar)	0 > 6.5 bar	↔	39.5 x 180	6.7 (HR110 included)	59 x 50 x 16 / 13.1





GYPRESS

# SYNERGIC RIVETING WORKSTATION

PNEUMATIC HYDRAULIC



## ACCESSIBILITY

16 languages

- FR PR CN
- GB CZ JP
- DE NL VN
- IT SE FI
- ES RU TR

★★★★ SYNERGIC RIVETS SETTINGS

Main panel



## 3 MODES

- MANUAL
- SYNERGIC
- CAR MANUFACTURERS

## CAR MANUFACTURERS COMPATIBILITY

- ✓ VW GROUP
- ✓ MERCEDES-BENZ
- ✓ BMW
- ✓ TESLA
- ✓ FERRARI
- ✓ FORD
- ✓ RENAULT ALPINE
- ✓ GM

## CONNECTIVITY

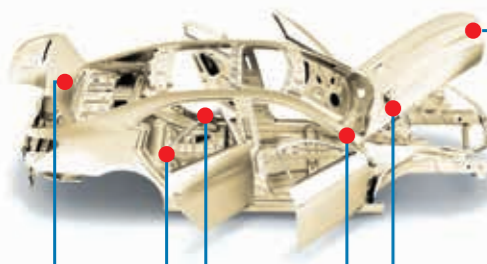

### TRACEABILITY

History data export

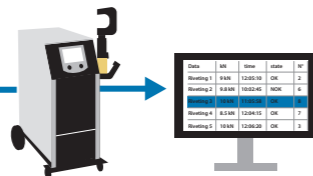

### SOFTWARE UPDATE

Gyspress evolutions

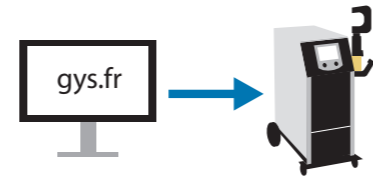

UNIQUE PUSH PULL SYSTEM by GYS

### PUSH PULL SYSTEM by GYS

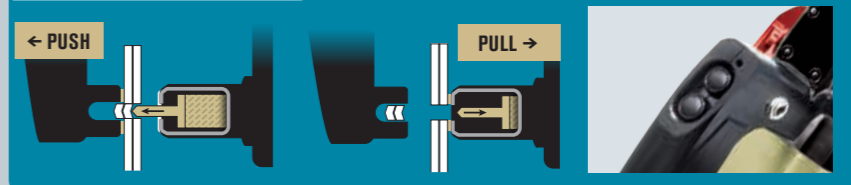

Gyspress support



Arms support



REGULATED PRESSURE CONTROL

POWER 10t

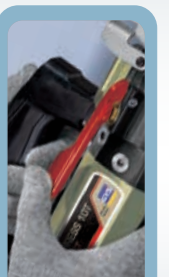

Discharge lever - Levier de décharge - Auslösehebel

### WORKSTATION GYPRESS 10T PP CONTROL

6.5 bar 100 kN

10t

063860

included



### OPTIONS

Pressure gauge - Capteur d'effort 10T PP CONTROL 071759



Youtube

Hydraulic body wrenches for GYPRESS 10T, 10T PushPull, 10T PP CONTROL (x2) 067325



MADE IN FRANCE WORKSTATION GYPRESS 10T PP CONTROL	230V	AIR BAR 6.5 bar = 10t (maxi 10 bar)	PRESSURE CONTROL 0 > 6.5 bar	SPEED CONTROL + -	LxWxH cm / kg	LxWxH cm / kg
					74 x 50 x 116 / 54	76 x 42 x 94 / 64.4

GYPRESS CONTROL

SYNERGIC RIVETING





**BLIND RIVET ADAPTERS  
- ADAPTATEURS POUR RIVETS AVEUGLES**

GYPESPRESS

Adaptators

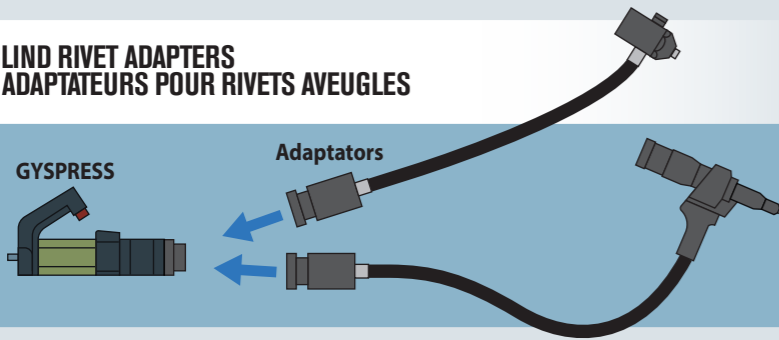

**Compatibility**

- GYPESPRESS 10T
- GYPESPRESS 10T PUSH PULL
- GYPESPRESS 10T PUSH PULL PREMIUM
- GYPESPRESS 10T CONNECT



Youtube

**BLIND RIVET ADAPTER 24 kN - Adaptateur 24 kn pour rivets aveugles - Blindnietadapter 24 kN**

**24 kN STANDARD** 600 mm  
063822

**Pour rivets POP - For BLIND rivets - Für Blindniet**  
Acier / Steel : Ø 4.0 → 6.4  
Alu: Ø 4.0 → 7.8



**INCLUDED**

- 058446
- for standard rivets: Ø 3.2 x1 059221, Ø 3.6 x1 059238
- Ø 4.0 x1 059245, Ø 4.5 x1 059252

**24 kN COMPACT** 600 mm  
077164

**Pour rivets POP - For BLIND rivets - Für Blindniet**  
Acier / Steel : Ø 6.4  
Alu: Ø 6.4 → 7.8

**COMPACT HEAD**



**INCLUDED**

- 058446
- for standard rivets: Ø 4.5 x1 081222, Ø 5.2 x1 079939

**OPTION**

- for extraction of self piercing rivet: Rivet-extraction insert - Buse d'extraction 24kN compact Ø 5 079946

**HIGH ACCESSIBILITY**



**SPECIFIC STORAGE**



**PERFECT COMBO WITH ARCPULL**

**SPECIAL TEARING RIVETS**  
- Spécial arrachage de rivets  
- Spezial-Zugnieten

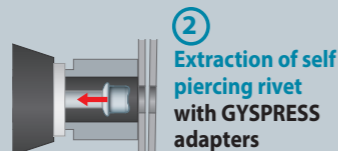
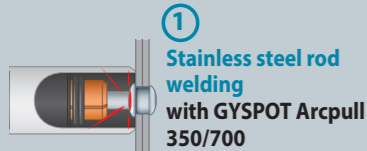

**OPTION FOR GYSPOT ARCPULL (details p.17)**

for GYSPOT ARCPULL 350

ARC PULL RIVET BOX1 350 - 24kN 064584					
Stainless steel nail - Tige inox Ø 4 x 50 mm 064607	Barrel for stainless steel nail welding - Canon pour pose de tige inox 059634	Mandrel support - Support porte-goujon 059634	Nozzle + pad - Buse + patin 059641	mandrel Ø4mm 049000	Buse d'extraction 24kN Ø 4 064683
x100	x1	x1	x1	x1	x1

**BLIND RIVET ADAPTER 50 kN - Adaptateur 50 kn pour rivets aveugles - Blindnietadapter 50 kN**



Stroke adjustment - Réglage de la course de traction  
0 → 25 mm

**50 kN** 1 m  
064867

± 4.0 kg

**For BLIND rivets - Pour rivets POP - Für Blindniet**

Steel / Acier : Ø 4.0 → 6.4  
Alu: Ø 4.0 → 7.8

**INCLUDED**

**Kit Standard**



**Complete kit** 065987



**OPTIONS**

Steel / Acier : Ø 4.0 → 6.4  
Alu: Ø 4.0 → 7.8

**160 mm extension - Extension 160 mm - Verlängerung 160 mm**  
066144



Ø 8.0 → 9.8

**Ø8.0/9.8mm nozzle-piece kit - Kit Rivets Ø8.0/9.8mm - Mundstückkit 8,0/9,8 mm**  
066045



M5 → M14  
M5 → M8

**Blind rivet nut pulling, Blind rivet bolt adapter kit - Kit 6 tirants pour pose d'écrous à sertir et goujons à sertir - Blindnietmuttern, Blindnietgewindebolzen-Kit**  
066076



**OPTION FOR GYSPOT ARCPULL (details p.17)**

for GYSPOT ARCPULL 350

ARCPULL RIVET BOX2 350 - 50kN 073388				
Ø 5 x 50 mm 070745	Long barrel + mandrel M5 - Canon long + mandrin M5 070738	Mandrel support - Support porte-goujon 059634	Buse + pad 059641	Buse d'extraction 50kN Ø 5 066151
x100	x1	x1	x1	x1

for GYSPOT ARCPULL 700

ARCPULL RIVET BOX 700 068452									
Ø 5 x 50 mm 070745	Long barrel + mandrel M5 - Canon long + mandrin M5 070738	Buse d'extraction 50kN Ø 5 066151	Mandrel support - Support porte-goujon 071377	Buse + pad 059641	Ring holder 059610	Rod for pulling rings - Fourche pour anneau 071384	Vis de butée 071384	Rod for pulling rings - Fourche pour anneau 071384	Vis de butée 071384
x100	x1	x1	x1	x1	x2	x1	x1	x1	x1

**CONSUMABLES BOX FOR 50KN ADAPTER - Boîte consommables pour adaptateur 50kN - Zubehörbox für 50 kN Adapter**

066168					
Blind rivet nuts - Écrous à sertir	Blind rivet bolts - Goujons à sertir	Blind rivets - Rivets aveugles	Blind rivet nuts - Écrous à sertir	Blind rivet bolts - Goujons à sertir	Blind rivets - Rivets aveugles
M5, M6, M8, M10, M12, M14	M5, M6, M8	Ø 6.4, Ø 9.8	M5, M6, M8	M5, M6, M8	Ø 6.4, Ø 9.8
22.5 → 27, 24 → 28.5, 23.5 → 28	2.8 → 4.8, 3.0 → 14.0	Ø 6.4, Ø 9.8	22.5 → 27, 24 → 28.5, 23.5 → 28	2.8 → 4.8, 3.0 → 14.0	Ø 6.4, Ø 9.8
0.5 → 3.0, 0.5 → 3.0, 0.5 → 3.0, 1.0 → 3.5, 1.0 → 4.0, 4.5 → 6.0	0.5 → 3.0, 0.5 → 3.0, 0.5 → 3.0	Ø 6.4, Ø 9.8	0.5 → 3.0, 0.5 → 3.0, 0.5 → 3.0	0.5 → 3.0, 0.5 → 3.0, 0.5 → 3.0	Ø 6.4, Ø 9.8
x 50 066175, x 50 066182, x 50 066199, x 50 066205, x 50 066212, x 10 066229	X 50 066236, X 50 066243, X 50 066250	x 50 066267, x 50 066274	X 50 066236, X 50 066243, X 50 066250	X 50 066236, X 50 066243, X 50 066250	x 50 066267, x 50 066274
+ demo metal sheet - plaque de démonstration	+ x 10 x 10 x 10 x 10 x 10 x 5	+ x 10 x 10 x 10	+ x 10 x 10 x 10	+ x 10 x 10 x 10	+ x 10 x 10



**Application of self-piercing rivets**  
- Pose de rivets auto-perçants  
- Stanzniet-Verpressen

**Application of solid rivets**  
- Pose de rivets pleins  
- Vollniet-Verpressen

**Application of Flow-form rivets**  
- Pose de rivets Flow-Form  
- Setzen v. Fließformnieten

**Extraction de rivets**  
- Extraction of rivets  
- Niet-Auspressen

**Metal sheet punching and shaping**  
- Perçage et formage des tôles pour rivets pleins  
- Vollniet-Lochstanzen/Prägen

2.0 < 6.5 mm    3 < 5.8 bar

2.3 < 8.3 mm    5.3 < 8 bar

2.3 < 8.3 mm

2.3 < 8.3 mm    8 bar

2.3 < 8.3 mm    8 bar

**DIES BOXES - Boîtes matrices - Matrzensätze**

**STANDARD**

**STANDARD 8T/10T**  
for 8T 10T  
053694  
Included XT11-21 058644

x1	x1	x1	x1	x1	x1	x1	x2	x1	x1	x1	x1	x1	x2	x4
A1	A2	B1	B2	F1	F2	D17	E1	E2	T1	T2				
Self-piercing rivets				Flow-form rivets			Extraction		Punching		key - clé	seals - joints		
Ø 3.2 > 3.5	Ø 3.3	Ø 5 > 5.3	Ø 5.3	Ø 6 - A1/2/3 S0/1/2/3/4/5/6			—	Ø 3.3 > 4.8	Ø 3.9 > 5.3	Ø 6				

**STANDARD 8T/10T PUSH PULL**  
for 8T PP 10T PP 10T CONTROL  
058361  
Included XT31-60 - 60 mm extension for HR310 (use with ST1, T5, T7) 057135  
+ XT11-21 058644

x1	x1	x1	x1	x1	x1	x2	x1	x1	x1	x1	x1	x2	x4
A1	A2	B1	B2	F1	F2	D17	E1	E2	ST1	T5	T7		
Self-piercing rivets				Flow-form rivets			Extraction		Punching		key - clé	seals - joints	
Ø 3.2 > 3.5	Ø 3.3	Ø 5 > 5.3	Ø 5.3	Ø 6 - A1/2/3 S0/1/2/3/4/5/6			—	Ø 3.3 > 4.8	Ø 3.9 > 5.3	Ø 6			

Ideal for aluminum & mild steel - Idéal aluminium et aciers doux

**Low pressure**  
Ø 6.4 mm

**High pressure**  
Ø 6.4 mm

**Flow-Form Ø 6 mm**

**Flow-Form Ø 8 mm**

**Punching Ø 10 mm holes**

**KIT RMB PP05**  
for 10T PP 10T CONTROL  
066366

**KIT RMB 08 PREMIUM**  
for 10T 10T PP 10T CONTROL  
066403

**KIT RMB 14 PREMIUM**  
for 10T 10T PP 10T CONTROL  
071186

**KIT RMB 15 PREMIUM**  
for 10T 10T PP 10T CONTROL  
071193

**KIT RMB 16 PREMIUM**  
for 10T 10T PP 10T CONTROL  
080867

**GM**

**RMB 11** for 10T  
071087

**RMB 11** → **RMB PP04** →  
Included XT31-60 - 60 mm extension for HR310

x1	x1	x1	x1	x1	x1	x1	x1	x1	x1	x3	x1	x1	x2	x2	x4	
F1	F2	F6	E9	E11	T1	T2	—	—	—	T7	T17	T18	T19	D18	D17	
Flow-form rivets				Extraction		Punching									key - clé	seals - joints
Ø 6				Ø 6 > 8		Ø 6										

**FERRARI**

**RMB 06**  
for 8T 10T 8T PP 10T PP 10T CONTROL  
059009

x1	x1	x1	x1	x1	x1	x2	x1	x1	x1	x2	x4		
B4	B5	B6	S3	S7	S8	D17	E1	E2	E13				
Self-piercing rivets						Extraction		Punching				key - clé	seals - joints
Ø 3.9	Ø 4.75		Ø 3.9	Ø 4.75	—	Ø 3.3 > 4.8	Ø 3.9 > 5.3	Ø 4.75					

**VW GROUP**

**RMB 03** for 8T 10T 8T PP 10T PP 10T CONTROL  
054257

x1	x1	x1	x1	x1	x1	x1	x1	x1	x1	x1	x1	x1	x1	x1	x1	x1	x2	x4										
A1	B1	S3	S7	S8	D8	D9	D17	D1	D2	D3	D4	D13	E2	S1	S4	S5	D5	D6	D7	D10	D11	D12	D15	D16				
Self-piercing rivets				Solid rivets		Extraction										Punching			key - clé	seals - joints								
Ø 3.2 > 3.5	Ø 5 > 5.3	Ø 3.9	Ø 4.75	Ø 4	Ø 6	Ø 3.2										Ø 3.9 > 5.3	Ø 3.2	Ø 5.3	Ø 8	Ø 4.8	Ø 4 > 8	Ø 4	Ø 6					

**NIO**

**RMB PP08** for 10T 10T PP 10T CONTROL  
072404  
Included XT31-60 - 60 mm extension for HR310

x1	x1	x1	x1	x1	x1	x1	x1	x1	x1	x1	x1	x3	x1	x2	x1	x2	x4		
B1	B2	F1	F2	F6	E2	E3	E9	E11	T5	ST1	T7	T17	T18	T19	D17	D18			
Self-piercing rivets		Flow-form rivets			Extraction			Punching									key - clé	seals - joints	
Ø 5.3	Ø 5.3	Ø 6			Ø 5.3			Ø 6	Ø 6										

**MERCEDES-BENZ**

**RMB 07** for 10T  
064454  
Included XT31-60 - 60 mm extension for HR3 (use with E3, E4, E5, E9, E10, E11) 057135

x1	x1	x1	x1	x1	x1	x1	x1	x1	x1	x1	x1	x1	x1	x1	x1	x1	x1	x2		
F1	F2	F3	F4	F5	—	—	—	E9	E10	E11	T1	T2	T3	T4						
Flow-form rivets								Extraction			Punching						clé - key			
Ø 6 - A1/2/3 S0/1/2/3/4/5/6								S28/38/48/58/68			S08/18	Ø 5.3 > 8	Ø 6	Ø 8	Ø 6 > 8	Ø 8	Ø 6	Ø 6	Ø 6	Ø 8

**RMB PP01** for 8T PP 10T PP 10T CONTROL  
058378  
Included XT31-60 - 60 mm extension for HR3

x1	x1	x1	x1	x1	x1	x1	x1	x1	x1	x1	x1	x1	x1	x1	x1	x1	x1	x2		
F1	F2	F3	F4	F5	—	—	—	E9	E10	E11	ST1	ST2	T5	T7	T8	T10				
Flow-form rivets								Extraction			Punching						clé - key			
Ø 6 - A1/2/3 S0/1/2/3/4/5/6								S28/38/48/58/68			S08/18	Ø 6 > 8	Ø 8	Ø 6	Ø 6	Ø 8	Ø 6	Ø 6	Ø 8	Ø 8

**FORD**

**RMB PP02** for 10T 8T PP 10T PP 10T CONTROL  
058835  
Included XT31-60 - 60 mm extension for HR3 (use with E7 & E12) 057135

x1	x1	x1	x1	x1	x1	x1	x1	x1	x1	x1	x1	x2	x4		
B1	G1	G2	G3	G4	G5	G6	E7	E12							
Self-piercing rivets								Extraction		Punching				key - clé	seals - joints
Ø 5 > 5.3								Ø 5 > 5.3		Ø 6					

**JAGUAR / LAND ROVER**

**RMB 02** for 8T 10T 8T PP 10T PP 10T CONTROL  
054271

x1	x1	x1	x1	x1	x1	x1	x1	x2	x4		
B1	B2	B3	S8	D2	E1	E6					
Self-piercing rivets				Extraction		Punching				clé - key	seals - joints
Ø 5 > 5.3	Ø 5.3	Ø 4.8	Ø 4.75	—	Ø 3.3 > 4.8	Ø 3.3 > 4.8					

**BMW**

**RMB 01** for 8T 10T 8T PP 10T PP 10T CONTROL  
054240

x1	x1	x1	x1	x1	x1	x2	x4		
A1	A2	B1	B2	E1	E2				
Self-piercing rivets						Extraction		key - clé	seals - joints
Ø 3.2 > 3.5	Ø 3.3	Ø 5 > 5.3	Ø 5.3	Ø 3.3 > 4.8	Ø 3.9 > 5.3				

**RMB 12** for 10T  
071094

**RMB 12** → **RMB PP07** →  
Included XT31-60 - 60 mm extension for HR310

x1	x1	x1	x1	x1	x1	x1	x1	x1	x1	x1	x1	x1	x1	x1	x3	x1	x1	x2	x2	x4		
B1	B3	I1	I2	I3	F1	F2	F6	E3	E13	T1	T2	—	—	ST1	T5	T7	T17	T18	T19	D18	D17	
Self-piercing rivets						Flow-form rivets			Extraction		Punching									key - clé	seals - joints	
Ø 5 > 5.3					Ø 6	Ø 6	Ø 6	Ø 3.3 > 4.8	Ø 9					Ø 6								

**PORSCHE**

**RMB 10** for 10T  
069299

**RMB 10** → **RMB PP06** →  
Included XT31-60 - 60 mm extension for HR310

x1	x1	x1	x1	x1	x1	x1	x1	x1	x1	x1	x1	x1	x1	x1	x3	x1	x2	x2	x4
B3	F2	E9	E11	—	—	T5	ST1	T7											
Flow-form rivets		Extraction		Punching													key - clé	seals - joints	
Ø 6		Ø 6 > 8		Ø 6															

**TESLA**

**RMB 09** for 8T 10T 8T PP 10T PP 10T CONTROL  
059931

x1	x1	x1	x1	x1	x1	x1	x1	x1	x1	x1	x1	x2	x4	
B1	H1	H2	H3	H4	H5	H6	H7	H8						
Self-piercing rivets													key - clé	seals - joints
Ø 5 > 5.3														

**RMB 13** for 10T  
071100

**RMB PP03** →  
Included XT31-60 - 60 mm extension for HR3 (use with E2, E3, E9, E10) 057135

x1	x1	x1	x1	x1	x1	x1	x1	x1	x1	x1	x1	x1	x1	x1	x1	x1	x1	x1	x2	x4
B1	S7	S8	F3	F4	F5	D17	E2	E3	E9	E10	—	—	—	—	ST2	T8	T10	—	—	
Self-piercing rivets				Flow-form rivets			Extraction				Punching						key - clé	seals - joints		
Ø 5 > 5.3	Ø 4.75	S28/38/48/58/68			S08/18	—	Ø 3.9 > 5.3	Ø 5.3 > 8	Ø 6 > 8	Ø 8					Ø 8				Ø 8	



**DIES - Matrices - Matrizen**

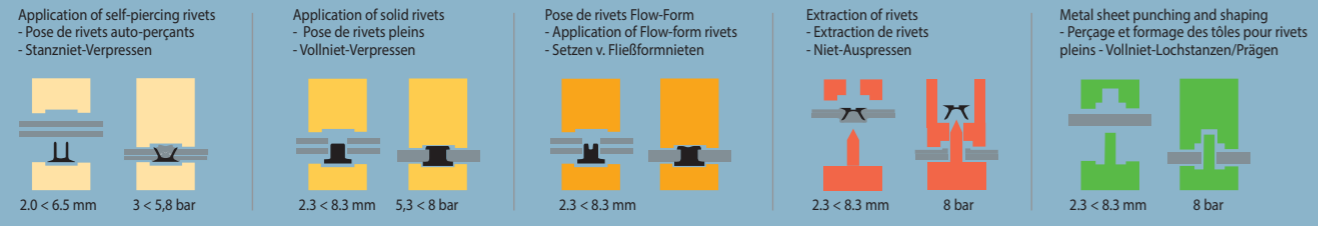

Ø 8																				
A1	A2	B1	B2	B3	B4	B5	B6	D1	D2	D3	D4	D5	D6	D7	D8	D9	D10	D11	D12	D13
055698	055704	055711	055728	055735	059016	059023	059030	055971	055988	055995	055742	056008	056015	056022	056039	056046	055674	056060	056053	055759
A1+A2		B1+B2																		
054295		054301																		

D15	D16	D17	D18	E1		E2	E3	E6	E7	E9	E10	E11	E12	E13	F1	F2	F3	F4	F45						
056077	056084	055681	071155	055865	054288	055766	057005	057142	057159	058606	058613	058620	058828	059085	055773	055780	055797	055803	083547						
				E1+E2																		F1+F2			
				054318																		054714			

F5	F6	G1	G2	G3	G4	G5	G6	H1	H2	H3	H4	H5	H6	H7	H8	I1	I2	I3	J1	J2
055810	071148	057173	057180	057197	057203	057210	057227	068230	068247	068254	068261	068278	068285	068292	068308	071117	071124	071131	071674	071902

Ø 6													Ø 6		Ø 6		Ø 8		Ø 6.7	
S1	S3	S4	S5	S7	S8	ST1	ST2	ST3	T1	T2	T3	T4	T5	T7	T8	T10	T12	T13		
057036	057043	057050	057067	057074	057081	058071	058088	066397	057098	059078	057104	055827	055834	058019	058033	058040	058064	066373	066380	
													T1+T2							
													054707							

BREVET GYS / GYS PATENT n° US 11,712,732

Ø 6.7		Ø 6		Ø 8		Ø 10	
T14	T15	T16	T17	T18	T19	T20	T25
066410	066427	068964	066434	069312	069329	071254	082854

**SELF PIERCING RIVETS (SPR)**  
- Rivets auto-perçants (RAP) - Stanznieten

Steel - Acier - Stahl

Complete box 048706

Ø 3,3 x 3,5 mm x 50	Ø 3,3 x 4 mm x 50	Ø 5,3 x 4 mm x 50	Ø 5,3 x 5 mm x 50	Ø 5,3 x 6 mm x 50	Ø 5,3 x 8 mm x 50	Ø 5,3 x 7 mm	Ø 5,3 x 9 mm
x 200 048232	x 200 048249	x 100 048256	x 100 048263	x 100 048270	x 100 048225	x 100 048638	x 100 048645

**SPECIAL CENTER PUNCH**  
- Pointeau centreur - Spezialkörner



**HYDROPNEUMATIC TOOL FOR BLIND RIVETS**  
- Riveteuse hydro-pneumatique - Hydro-pneum. Blindnietgerät

For BLIND rivets - Pour rivets POP - Für Blindniet  
Steel → 6.4 mm  
Alu → 7.8 mm  
Ø 4.0 → 7.8

**HR21**  
max 21 000 N (6 bar)  
055407

MADE IN ITALY

included (x3) 058446

For standard rivets Ø 4.0 51508

For Magnarive rivets Ø 4.5 51507

Option HR21 extension 100 mm 063105

**CORDLESS RIVETER - Riveteuse sur batterie**  
- Akku-Blindnietgerät

For BLIND rivets - Pour rivets POP - Für Blindniet  
Ø 4.0/4.8/5.0/6.0/6.4

**TWO ER20**  
max 20 000 N (6 bar)  
10-20 V universal fast charger (30 min)  
2.0 kg  
064461

BRUSHLESS motor

2 x 20V/2Ah Li-ion battery

**HYDROPNEUMATIC TOOL FOR BLIND RIVETS**  
hydro-pneumatique - Hydro-pneum. Blindnietgerät

For BLIND rivets - Pour rivets POP - Für Blindniet  
Steel / Acier Ø 4.0/4.8/6.4  
Alu Ø 4.0/4.8/6.4

**HR14**  
max 14 000 N  
057241

Made in Taiwan

**MANUAL TOOL FOR BLIND RIVETS**  
- Riveteuse manuelle - Manueller Blindnietgerät

For BLIND rivets - Pour rivets POP - Für Blindniet  
Steel / Acier Ø 3.2/4.0/4.8/6.4  
Alu Ø 3.2/4.0/4.8/6.4

**061323**  
Made in Taiwan

**HYDROPNEUMATIC TOOL FOR RIVET NUTS**  
hydro-pneumatique riv 998 - Hydro-pneum. Blindnietmuttergerät

Sealing nuts - Ecrous à sertir - Blindnietmuttern

**RIV 998**  
For sealing nuts from M3 to M12  
Pour la pose d'écrous à sertir M3 à M12

max 19 000 N (6 bar)  
included accessories for sealing nuts:  
- livré avec accessoires pour écrous à sertir:

- ✓ M3 ✓ M4
- ✓ M5 ✓ M6
- ✓ M8 ✓ M10
- ✓ M12

055414

MADE IN ITALY

**HYDROPNEUMATIC TOOL FOR BLIND RIVETS**  
- Riveteuse hydro-pneumatique - Hydro-pneum. Blindnietgerät

For BLIND rivets - Pour rivets POP - Für Blindniet  
Steel / Acier Ø 3.2/4.0/4.8  
Alu Ø 3.2/4.0/4.8

**HR9**  
max 9 000 N  
057234

Made in Taiwan





# MIG-MAG GMAW-FCAW

## TRADITIONAL

GYS AUTO	86
----------	----

## INVERTER

E GYS AUTO	88
------------	----

**NEW**

P GYS AUTO	90
------------	----

AUTOPULSE	92
-----------	----

ACCESSORIES & CONSUMABLES	96
---------------------------	----





# MIG/MAG TRADITIONAL SYNERGIC

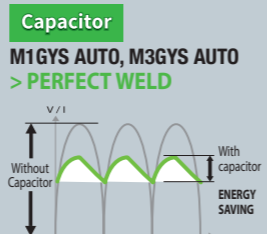

**SYNERGIC EASY TO USE**  
Auto adaptative wire speed  
- Réglage automatique de la vitesse  
- Automatische Einstellung der Drahtgeschwindigkeit

### M1 GYS AUTO

**15 → 160 A** Capacitor

230V • 1~

032903

208/240V • 1~

032088

with accessories

### T1 GYS AUTO DV

**15 → 200 A**

400V • 3~ / 230V • 3~

032927

with accessories

### M3 GYS AUTO

**15 → 160 A** Capacitor

230V • 1~

032880

with accessories

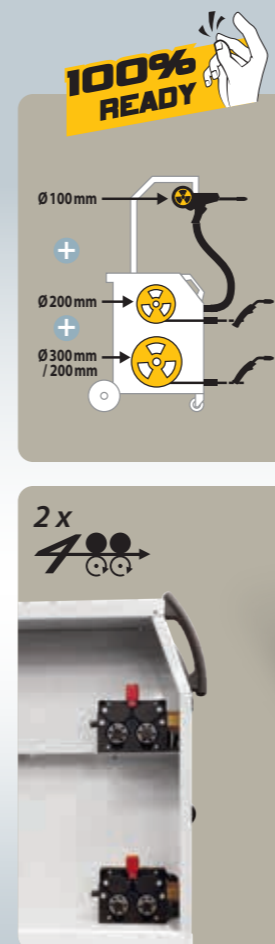

Protection gas  
Argon+CO<sub>2</sub> (Steel, Inox)  
Argon (ALU/CuSi3/CuAl8)  
CO<sub>2</sub>PUR (Steel)

### Spool Gun Torch - Torche motorisée Spool Gun - Spool Gun Brenner



### SPOOL GUN + Support for M3 GYS AUTO



MADE IN FRANCE	MADE IN GYS CHINA	CE MARKING 60974/1	50/60 Hz	A	min → max	Reg	Ø mm			Electronic Control	EN60974-1 (40°C)		Original equipment Equipment d'origine Originalausstattung Equipamiento de fabrica	LxWxH cm / kg	Protected & compatible power generator (+/-15%)		
							100 (spoolgun)	200	300		IA (60%)	X% (I2 max)					
			230V 1~				option	■	■	400	90	140A@15%	0.6+1	0.6/0.8	0.8	78 x 38 x 67 / 56	4,5 kVA
			208/240V 1~	16	15 → 160	6	option	■	■	400	90	140A@15%	0.6+1	0.6/0.8	0.8	37 x 79 x 67 / 57.5	4,5 kVA
			230V 3~/400V 3~	10	15 → 200	7	option	■	■	400	110	150A@25%	0.6+1	0.6/0.8	0.8	37 x 78 x 67 / 62	5.2 kVA
			230V 1~	16	15 → 160	6	■	■	■	400	90	140A@15%	0.6+1	0.6/0.8 0.8/1.0	2 x 0.8	74 x 40 x 85 / 77.5	4,5 kVA





E GYS AUTO

# MIG/MAG INVERTER SYNERGIC

Lastest generation  
colour screen 3.5"

### 16 languages

- French
- English
- German
- Italian
- Spanish
- Portuguese
- Czech
- Polish
- Dutch
- Swedish
- Russian
- Chinese
- Japanese
- Vietnamese
- Finnish
- Turkish

### EASY



### EXPERT

Pre-gas / Creep speed/ Hotstart /  
Crater filler / Burnback / Post-gas



### EASY TO SETUP



Screen protection -  
Protection d'écran -  
Bildschirmschutz  
079885

### MODES

- MANUAL
- SYNERGIC EASY / EXPERT
- 2T
- 4T
- SPOT
- DELAY

### FONCTIONS

- TRACEABILITY
- PORTABILITY
- +500 JOBS can be saved

### SYNERGIES

- STEEL
- AlSi
- AlMg
- Cu Si 3 / CuAl 8
- CrNi

### UPDATES



USB key 16 Gb  
062344

### E1 GYS AUTO

10 **200 A** 230V 1~ PFC

with accessories :

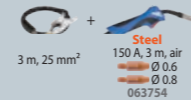

075122

### E2 GYS AUTO

10 **200 A** 230V 1~ PFC

with accessories :

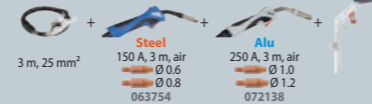

075139

### E3 GYS AUTO

10 **200 A** 230V 1~ PFC

with accessories :

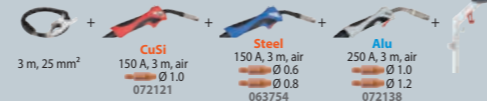

075160



4 m³  
(20L)

1 x

6 m

E1 GYS AUTO 200 A • × 1



2 x 4 m³  
(20L)

2 x

6 m

E2 GYS AUTO 200 A • × 2

2 x 4 m³  
(20L)

3 x

6 m

E3 GYS AUTO 200 A • × 3



### PFC POWER FACTOR CORRECTION

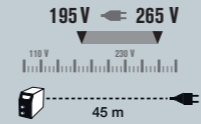

Cable support E2/E3  
077300



Helmet not included

MADE IN FRANCE	CE NORM. 60974/1	50/60 Hz	A	6 m	min → max A	Ø mm		Electronic Control	EN60974-1 (40°C)		Original equipment Equipement d'origine Originalausstattung Equipamiento de fabrica	LxWxH cm / kg	Protected & compatible power generator (+/-15%)	
						200	300		IA (60%)	X% (I2 max)				
▪	E1 GYS AUTO	230V 1~	16	6 m	10 → 200	▪	▪		145	200 A @ 20%	0.6 → 1	Acier Type B 0.6/0.8	79 x 37 67 / 42.6	9KVA
▪	E2 GYS AUTO	230V 1~	16	6 m	10 → 200	▪	▪		145	200 A @ 20%	0.6 → 1	Acier Type B 0.6/0.8 Alu Type B 0.8/1	72 x 37 x 105 / 59.5	9KVA
▪	E3 GYS AUTO	230V 1~	16	6 m	10 → 200	▪	▪		145	200 A @ 20%	0.6 → 1	Acier Type B 0.6/0.8 Acier Type B 0.8/1 Alu Type B 0.8/1	73 x 38 x 108 / 64	9KVA





P GYS AUTO

# MIG/MAG PULSE SYNERGIC

**NEW**

Lastest generation colour screen 3.5"

16 languages

- French
- English
- German
- Italian
- Spanish
- Portuguese
- Czech
- Polish
- Dutch
- Swedish
- Russian
- Chinese
- Japanese
- Vietnamese
- Finnish
- Turkish

**EASY**



**EXPERT**

Pre-gas / Creep speed/ Hotstart / Crater filler / Burnback / Post-gas



**EASY TO SETUP**



Screen protection - Protection d'écran - Bildschirmschutz 079885

**MODES**

**EASY**

- SYNERGIC STANDARD
- SYNERGIC PULSE

**EXPERT**

- MANUAL
- SYNERGIC STANDARD
- SYNERGIC PULSE

**TORCH**

**2T**

**4T**

**SPOT**

**SPOT DELAY**

**FONCTIONS**

**TRACEABILITY**

**PORTABILITY**

+500 JOBS can be saved

**SYNERGIES**

**STEEL - ACIER**

**ALU**

**STAINLESS STEEL - INOX**

**BRAZING - BRASAGE**

+40 SYNERGIES

**UPDATES**



**EASY USB UPDATE**

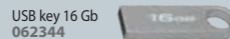

USB key 16 Gb 062344

**10 → 220 A**  
Ideal 0.6 mm

**P1 GYS AUTO**

**10 → 220 A** 230V 1~ PFC

with accessories :

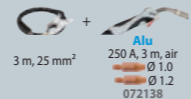

080584

**P1 GYS AUTO 208-240V**

**10 → 220 A** 208>240V 1~ PFC

with accessories :

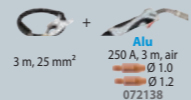

080911



1 x

**P1 GYS AUTO 220 A • × 1**

**P2 GYS AUTO**

**10 → 220 A** 230V 1~ PFC

with accessories :

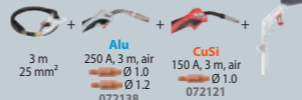

083134

**P2 GYS AUTO 208-240V**

**10 → 220 A** 208>240V 1~ PFC

with accessories :

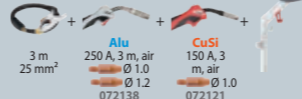

083189

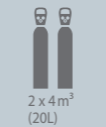

**NEW**  
06/2024

2 x

**P2 GYS AUTO 220 A • × 2**

**P3 GYS AUTO**

**10 → 220 A** 230V 1~ PFC

with accessories :

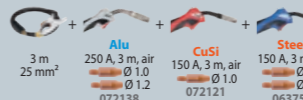

080591

**P3 GYS AUTO 208-240V**

**10 → 220 A** 208>240V 1~ PFC

with accessories :

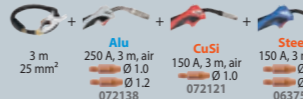

080928

Cable support P2/P3 077300

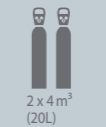

**NEW**

3 x

**P3 GYS AUTO 220 A • × 3**

MADE IN FRANCE	CE NORM. 60974/1	50/60 Hz	A	6m	min → max	A	200	300	Electronic Control	EN60974-1 (40°C)		Ø mm	Original equipment / Equipement d'origine / Originalausstattung / Equipamiento de fabrica			LxWxH cm / kg	Protected & compatible power generator (+/-15%)
										IA (60%)	X% (I2 max)		Alu Type B 1.0/1.2	Steel Type B 0.8/1.0	Steel Type B 0.6/0.8		
▪	<b>P1 GYS AUTO</b>	230V 1~	16							150	220 A @ 20 %	0.6 → 1.2	Alu Type B 1.0/1.2		78 x 45 x 80 / 45	9KVA	
▪	<b>P1 GYS AUTO 208-240V</b>	208 > 240V 1~	16	6m	10 → 220	▪	▪	▪	1 x	150	220 A @ 20 %	0.6 → 1.2	Alu Type B 1.0/1.2		78 x 45 x 80 / -	9KVA	
▪	<b>P2 GYS AUTO</b>	230V 1~	16							150	220 A @ 20 %	0.6 → 1.2	Alu Type B 1.0/1.2	Steel Type B 0.8/1.0	86 x 63 x 93 / 58	9KVA	
▪	<b>P2 GYS AUTO 208-240V</b>	208 > 240V 1~	16	6m	10 → 220	▪	▪	▪	2 x	150	220 A @ 20 %	0.6 → 1.2	Alu Type B 1.0/1.2	Steel Type B 0.8/1.0	86 x 63 x 93 / -	9KVA	
▪	<b>P3 GYS AUTO</b>	230V 1~	16							150	220 A @ 20 %	0.6 → 1.2	Alu Type B 1.0/1.2	Steel Type B 0.8/1.0	86 x 63 x 93 / 62	9KVA	
▪	<b>P3 GYS AUTO 208-240V</b>	208 > 240V 1~	16	6m	10 → 220	▪	—	—	3 x	150	220 A @ 20 %	0.6 → 1.2	Alu Type B 1.0/1.2	Steel Type B 0.8/1.0	86 x 63 x 93 / -	9KVA	



91

P GYS AUTO  
PULSE SYNERGIC MIG  
GMAW  
FCAW





AUTOPULSE

# MIG/MAG DOUBLE PULSE SYNERGIC

Latest generation  
colour screen 5"  
800 x 480 (WVGA)



## ACCESSIBILITY

3 interface levels

- EASY
- EXPERT
- ADVANCED

16 languages

- French
- English
- German
- Italian
- Spanish
- Portuguese
- Czech
- Polish
- Dutch
- Swedish
- Russian
- Chinese
- Japanese
- Vietnamese
- Finnish
- Turkish

EASY



3 INTERFACE LEVELS

ADVANCED  
Arc length adjustments



EXPERT

Pre-gas / Hot Start / Upslope / Downslope / Crater filler / Post-gas



500+ JOBS can be saved



TRACEABILITY



PORTABILITY



MODES

- DYNAMIC STANDARD
- PULSE
- PULSE IN PULSE
- MANUAL
- COLD PULSE

FULLY DIGITAL

4 MICROPROCESSORS



65+ SYNERGIES

Find all the synergies:  
Retrouvez toutes les synergies:  
Finde alle Synergien:



STEEL

Cu Si 3 / Cu Al 8

ALU

UPDATES

EASY USB UPDATE

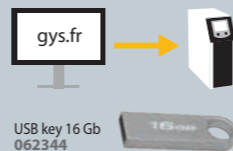

USB key 16 Gb  
062344

OPTIONS

PUSH PULL TORCH 24 V



MB 25  
4 m  
046283



MB 15 / MB 25  
(250 A)  
077089

- x5 (M6-0.6)
- x5 (M6-0.8)
- x5 (M6-1.0)
- x5 (Alu-M6-0.1.0)
- x5 (Alu-M6-0.1.2)



Torch gas flow-meter  
- Débitmètre de  
bout de torche

053939



Protection cover  
- Housses de protection  
- Schutzhaube  
052260



ELECTRONIC

AUTOPULSE 220-M1



AUTOPULSE 220-M2



AUTOPULSE 220-M1

10 220 A

230V 1~

PFC

with accessories:

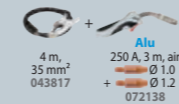

4 m,  
35 mm²  
043817



Alu  
250 A, 3 m, air  
Ø 1.0  
+ Ø 1.2  
072138

065024



AUTOPULSE 220-M2

10 220 A

230V 1~

PFC

with accessories:

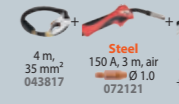

4 m,  
35 mm²  
043817



Steel  
150 A, 3 m, air  
Ø 1.0  
072121



Alu  
250 A, 3 m, air  
Ø 1.0  
+ Ø 1.2  
072138

069855

AUTOPULSE 220-M2 208-240V

10 220 A

208>240V 1~

PFC

with accessories:



4 m,  
35 mm²  
043817



Steel  
150 A, 3 m, air  
Ø 1.0  
072121



Alu  
250 A, 3 m, air  
Ø 1.0  
+ Ø 1.2  
072138

069862

10 m³  
(50L)



8 m

PFC POWER FACTOR CORRECTION

185 V ← 265 V



45 m

220 A • × 1

220 A • × 2

MADE IN FRANCE EN60974-1	50 / 60 Hz	A	Ø mm	min → max	SPOOLGUN	PUSH/PULL	200 / 300	Cooling system	ELECTRONIC CONTROL	EN60974-1 (40°C)		LxWxH cm / kg	Protected & compatible power generator (+/-15%)	
										IA (60%)	X% (I2 max)			
AUTOPULSE 220-M1	230 V · 1~	8 m	16	0.6 → 1.2	10 → 220	-	OPTION	Air		ALU : Type B 1.0 / 1.2	150	220 A @ 20%	75 x 41 x 94 / 65.5	10 kVA
AUTOPULSE 220-M2	230 V · 1~	8 m	16	0.6 → 1.2	10 → 220	-	OPTION	Air		ACIER : Type B 0.8 / 1.0 mm ALU : Type B 1.0 / 1.2	150	220 A @ 20%	74 x 41 x 93 / 78.8	10 kVA
AUTOPULSE 220-M2 208-240V	208 > 240 V · 1~												74 x 40 x 93 / 79.8	

AUTOPULSE

INVERTER PULSE MIG 1





# MIG/MAG DOUBLE PULSE SYNERGIC

BODYSHOP SPECIFIC  
**COLD PULSE**  
CuSi3 Ø 0.8/1



Helmet not included

2 x 4 m<sup>3</sup>  
(20L)

3 x

8 m

PFC POWER FACTOR CORRECTION

185 V ← 265 V

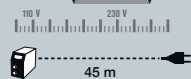

**AUTOPULSE 220-M3**

1				PP
2			-	-
3			-	-

ELECTRONIC

**AUTOPULSE 220-M3**  
10 **220 A** 230V 1~ PFC

with accessories:  
4 m, 35 mm<sup>2</sup> 043817 + CuSi 150 A, 3 m, air Ø 1.0 072121 + Steel 150 A, 3 m, air Ø 0.8 063754 + Alu 250 A, 3 m, air Ø 1.0 Ø 1.2 072138

**AUTOPULSE 220-M3 208-240V**  
10 **220 A** 208>240V 1~ PFC

with accessories:  
4 m, 35 mm<sup>2</sup> 043817 + CuSi 150 A, 3 m, air Ø 1.0 072121 + Steel 150 A, 3 m, air Ø 0.8 063754 + Alu 250 A, 3 m, air Ø 1.0 Ø 1.2 072138

036703 / 062481

**OPTIONS**

**PUSH PULL TORCH 24 V**

MB 25 4m 046283

Motor inside

Torch gas flow-meter - Débitmètre de bout de torche 053939

MB 15 / MB 25 (250 A) 077089

Protection cover - Housse de protection - Schutzhaube 052260

- x5 (Mg-0.6)
- x5 (Mg-0.8)
- x5 (Mg-1.0)
- x5 (Mg-0.8)
- x5 (Mg-1.0)
- x5 (Alu - Mg-0.10)
- x5 (Alu - Mg-0.12)

**AUTOPULSE 320-T1**

1				PP
2	-	-	-	-
3	-	-	-	-

ELECTRONIC

**AUTOPULSE 320-T3**

1				PP
2				-
3				-

ELECTRONIC

**AUTOPULSE 320-T3 208-240V**

1				PP
2				-
3				-

ELECTRONIC

**AUTOPULSE 320-T1**  
15 **320 A** 400V 3~

with accessories:  
4 m, 35 mm<sup>2</sup> 043817 + Alu 250 A, 3 m, air Ø 1.0 Ø 1.2 072138

069831



10 m<sup>3</sup>  
(50L)

1 x

5 m

**AUTOPULSE 320-T3**  
15 **320 A** 400V 3~

with accessories:  
4 m, 35 mm<sup>2</sup> 043817 + Steel 250 A, 3 m, air Ø 1.0 072152 + Steel 250 A, 3 m, air Ø 0.8 072145 + Alu 250 A, 3 m, air Ø 1.0 Ø 1.2 072138

067615

**AUTOPULSE 320-T3 208-240V**  
15 **320 A** 208>240V 3~ PFC

with accessories:  
4 m, 35 mm<sup>2</sup> 043817 + Steel 250 A, 3 m, air Ø 1.0 072152 + Steel 250 A, 3 m, air Ø 0.8 072145 + Alu 250 A, 3 m, air Ø 1.0 Ø 1.2 072138

036970

2 x 4 m<sup>3</sup>  
(20L)

3 x

**OPTIONS**

for AUTOPULSE 320-T3 (400V) only

**SPOOLGUN TORCH**

**Ideal Alu**

Ø 0,8

4m 041486

Motor inside

Ø 100

220 A • x 3

320 A • x 1

320 A • x 3

MADE IN FRANCE EN60974-1	50 / 60 Hz	A	Ø mm	min → max	SPOOLGUN	PUSH/PULL	200	Cooling system	Equipement d'origine Original equipment Originalausstattung Equipamiento de fabrica		EN60974-1 (40°C)	LxWxH cm / kg	Protected & compatible power generator (+/-15%)
									ELECTRONIC CONTROL	IA (60%) X% (I2 max)			
<b>AUTOPULSE 220-M3</b>	230 V · 1~	8 m	16	0.6+1.2	10+220	-	OPTION	Air		ACIER : Type B 0.6 / 0.8 ACIER : Type B 0.8 / 1.0 ALU : Type B 1.0 / 1.2	150 220 A @ 20%	75 x 41 x 94 / 80	10 kVA
<b>AUTOPULSE 220-M3 208-240V</b>	208>240 V · 1~	8 m	16	0.6+1.2	10+220	-	OPTION	Air		ACIER : Type B 0.6 / 0.8 ACIER : Type B 0.8 / 1.0 ALU : Type B 1.0 / 1.2	150 220 A @ 20%	75 x 41 x 94 / 80	10 kVA

MADE IN FRANCE EN60974-1	50 / 60 Hz	A	Ø mm	min → max	SPOOLGUN	PUSH/PULL	200 300	Cooling system	Original equipment Equipement d'origine Originalausstattung Equipamiento de fabrica		EN60974-1 (40°C)	LxWxH cm / kg	Protected & compatible power generator (+/-15%)
									ELECTRONIC CONTROL	IA (60%) X% (I2 max)			
<b>AUTOPULSE 320-T1</b>	400 V · 3~	5 m	16	0.6+1.2	15+320	-	OPTION	Air		ALU : Type B 1.0 / 1.2	260 320 A @ 35%	74 x 41 x 94 / 65.1	16 kVA
<b>AUTOPULSE 320-T3</b>	400 V · 3~	5 m	16	0.6+1.2	15+320	OPTION	OPTION	Air		ACIER : Type C 0.8 / 1.0 mm ALU : Type C 1.0 / 1.2	260 320 A @ 35%	75 x 40 x 94 / 82	16 kVA
<b>AUTOPULSE 320-T3 208-240V</b>	208-240 V · 3~	5 m	25	0.6+1.2	15+320	-	OPTION	Air		ACIER : Type C 0.8 / 1.0 mm ALU : Type C 1.0 / 1.2	260 320 A @ 35%	74 x 41 x 95 / 82	16 kVA

AUTOPULSE  
INVERTER PULSE MIG 3



# MANUAL TORCHES

- Torches manuelles - Brenner  
- Antorcha - Lastoort - Tocha

## CLASSIC



Flexible



## CLASSIC GRIP



CONFORT GRIP

360°

## FUME EXTRACTION

Fume Extraction Torches - Torches aspirantes - Rauchgas-Absaugbrenner - Antorcha con aspiración de humos



Complete systems (p. 121)



## PUSH PULL

for AUTOPULSE



## SPOOL GUN

Special CAR BODY REPAIR MACHINES

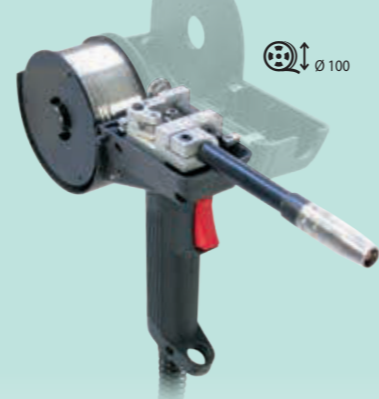

## COMPLETE TORCHES

X % 40°C, ArCo <sub>2</sub>	Steel/Stainless steel - Acier / Inox - Stahl/Edelstahl						ALU - Aluminium - Aluminio					PUSH PULL AIR	SPOOL GUN AIR
	AIR			LIQUID			AIR			LIQUID			
	150 A	150 A	250 A	250 A	350 A	300 A	150 A	250 A	250 A	350 A	300 A		
	A1 + A2	A1 + A2	B1 + B2	B1 + B2	D1 + D2	C1 + C2	A1 + A2	B1 + B2	B1 + B2	D1 + D2	C1 + C2	B1 + B2	A1 + A2
	M6 Ø0.8	M6 Ø1.0	M6 Ø0.8	M6 Ø1.0	M8 Ø1.2	M6 Ø1.2	M6 Ø0.8	M6 Ø1.0	M6 Ø1.2	M8 Ø1.2	M6 Ø1.2	M6 Ø1.2	M6 Ø0.8
	3 m	3 m	3 m	3 m	4 m	3 m	3 m	3 m	3 m	3 m	3 m	4 m	4 m
	063754	072121	072145	072152	063792	040694	063761	063785	072138	063808	040748	046283	041486
	3 m		4 m	3 m	4 m		3 m	3 m		3 m	4 m		
	082151		063778	040687	043275		041462	040724		Carbon liner 040731	043282		
	3 m		3 m	4 m						4 m			
	041424		040700	040946						040939			
	3 m		4 m	4 m									
	043268		040922	040557									
	3 m		3 m										
	043251		040540										

Anti-spatter spray (without silicone)  
- Spray protecteur sans silicone  
- Antihafspray (Ohne Silicon)

041806

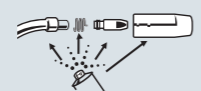

MIG torch stand with magnetic base  
- Support torche magnétique

041653



# CONSUMABLES - Consommables

Gas nozzles - Buses - Düsen - Tubo - Nippel - Bicos

A	B	C	D	E
Conical nozzle - Buse conique - Konische Düse	Spot welding - Pointage - Punktöse	Nail welding - Soude clou - Nagelschweißdüse	Special No Gas (isolated) - Isolée spéciale Sans gaz	Conical nozzle - Buse conique - Konische Düse

Torch liners - Gainses  
- Mantel - Funda  
- Drahtseelen - Folha  
(p. 103)

Tip adaptors & diffusers  
- Supports tube contact & diffuseurs

A1	B1	C1	D1	A2	B2	C2	D2

Contact tips - Tubes contacts  
- Kontaktröhre - Tubo de contacto  
- Contactbuis - Pontas de contacto

A	B	C

## Tip adaptors & diffusers - Supports tube contact & diffuseurs

	Steel/Stainless steel - Acier / Inox - Stahl/Edelstahl				ALU - Aluminium - Aluminio				PUSH PULL		SPOOL GUN
	AIR		LIQUID		AIR		LIQUID		AIR		AIR
	150 A	250 A	350 A	300 A	150 A	250 A	350 A	300 A	150 A	250 A	150 A
	A1 (x5)	B1 (x5)	D1 (x3)	C1 (x3)	A1 (x5)	B1 (x5)	D1 (x3)	C1 (x3)	A1 (x5)	B1 (x5)	A1 (x5)
	042902	042995	043008	043589	042902	042995	043008	043589	042902	042995	042902
	A2 (x10)	B2 (x5)	D2 (x5)	C2 (x5)	A2 (x10)	B2 (x5)	D2 (x5)	C2 (x5)	A2 (x10)	B2 (x5)	A2 (x10)
	042988	042919	042926	043541	042988	042919	042926	043541	042988	042919	042988

## Contact tips - Tubes contacts - Kontaktröhre - Tubo de contacto - Contactbuis - Pontas de contacto

	150 A	250 A	350 A	300 A	150 A	250 A	350 A	300 A	150 A	250 A	150 A
	A (x10) 041905	A (x10) 041905	—	A (x10) 041905	—	—	—	—	—	—	—
	A (x10) 041912	B (x10) 041950	C (x10) 041790	B (x10) 041950	B (x10) 041059	A (x10) 041059	—	B (x10) 041059	B (x10) 041059	B (x10) 041059	B (x10) 041059
	A (x10) 041929	B (x10) 041967	C (x10) 419803	B (x10) 041967	B (x10) 041066	B (x10) 041066	C (x10) 419766	B (x10) 041066	B (x10) 041066	B (x10) 041066	B (x10) 041066
	A (x10) 040144	B (x10) 041974	C (x10) 419810	B (x10) 041974	B (x10) 041073	B (x10) 041073	C (x10) 419773	B (x10) 041073	B (x10) 041073	B (x10) 041073	B (x10) 041073
	—	—	C (x10) 419827	—	—	—	—	—	—	—	—
	—	—	C (x10) 419834	—	—	—	C (x10) 041080	—	—	—	—
	—	—	C (x10) 040533	—	—	—	—	—	—	—	—

## Gas nozzles - Buses - Düsen - Tubo - Nippel - Bicos

	150 A	250 A	350 A	300 A	150 A	250 A	350 A	300 A	150 A	250 A	150 A		
	53 mm Ø12 (x3) 041875	57 mm Ø15 (x3) 041882	84 mm Ø16 (x3) 041783	63.5 mm Ø12 (x3) 043534	53 mm Ø12 (x3) 041875	53 mm Ø16 (x3) 046214	57 mm Ø15 (x3) 041882	84 mm Ø16 (x3) 041783	63.5 mm Ø12 (x3) 043534	63.5 mm Ø17 (x3) 046221	53 mm Ø12 (x3) 041875	57 mm Ø15 (x3) 041882	53 mm Ø12 (x3) 041875
	53 mm (x1) 041851	—	—	—	—	—	—	—	—	—	—	—	—
	53 mm (x1) 041523	—	—	—	—	—	—	—	—	—	—	—	—
	(x1) 041868	—	—	—	—	—	—	—	—	—	—	—	—
	(x1) 043084	(x1) 040571	(x1) 040588	—	—	—	—	—	—	—	—	—	—

## Boxes

- Coffrets - Verschleißteilebox  
- Cajas - Kistjes - Estojos



	x 3		x 5		M6 - Ø0.6 x 5 M6 - Ø0.8 x 5 Alu - M6 - Ø0.8 x 5		x 3	=	<b>MB 15 (150 A)</b> 041226
	M6 - Ø0.6 x 5 M6 - Ø0.8 x 5 Alu - M6 - Ø1.0 x 5		M6 - Ø0.8 x 5 M6 - Ø1.0 x 5 Alu - M6 - Ø1.0 x 5		—		—	=	<b>MB 15 / MB 25</b> 077089
	x 5		x 3		M6 - Ø0.8 x 5 M6 - Ø1.0 x 5 Alu - M6 - Ø1.0 x 5		x 3	=	<b>MB 25 (250 A)</b> 041233
	x 2		x 3		M6 - Ø1.0 x 5 M6 - Ø1.2 x 5 Alu - M6 - Ø1.0 x 5 Alu - M6 - Ø1.2 x 5		x 2	=	<b>MB 36 (350 A)</b> 041417



# CONSUMABLES - Consommables

## TORCH LINERS - Gainses - Mantel - Funda - Drahtseelen - Folha



STEEL - Acier - Stahl - Acero - Staal - Aço			
Ø 0.6 / 0.8	3 m	041592	
	4 m	041837	
Ø 1.0 / 1.2	3 m	041608	
	4 m	041844	
	5 m	062276	
Ø 1.2 / 1.6	3 m	418417	
	4 m	418424	
Ø 1.6 / 2.4	4 m	040526	
	5 m	062290	

TEFLON			
Ø 0.6 / 0.8	3 m	041578	
	4 m	044050	
Ø 1.0 / 1.2	3 m	041585	
	4 m	044067	
	8 m	038677	
Ø 1.2 / 1.6	4 m	044074	



Guide gaine téflon pour motodévidoir 079601

CARBON			
Ø 0.6 / 0.8	4 m	039834	
	5 m	062306	
Ø 1.0 / 1.2	4 m	039827	
	5 m	062313	
Ø 1.2 / 1.6	4 m	039810	

### PUSH PULL TORCH

Ø 1.0 / 1.2	8 m	038172	
-------------	-----	--------	--

## ROLLERS - Galets - Vorschubrollen - Rollen - Rodillos - Wielen - Roletes

### TYPE A

For : Carmig



Steel, Stainless steel - Acier, Inox	Ø 0.6 / 0.8	x1	042339
	Ø 0.8 / 1.0	x1	041189
Alu	Ø 0.8 / 1.0	x1	041196
Cored wire - Fil fourré	Ø 0.8 / 0.9	x1	046856
	Ø 0.9 / 1.2	x1	042346



### TYPE B

For : Autopulse 220, Autopulse 320-T1, M1 GYS Auto, M3 GYS auto, T1 GYS Auto, T3 GYS Auto, E1/E2/E3 GYS Auto



Steel, Stainless steel - Acier, Inox	Ø 0.6 / 0.8	x1	042087
	x2	042353	
Alu	Ø 0.8 / 1.0	x1	042100
	x2	042360	
Cored wire - Fil fourré	Ø 1.0 / 1.2	x1	042179
	x2	046849	
Alu	Ø 1.2 / 1.6	x2	042384
	x1	042155	
Cored wire - Fil fourré	Ø 0.8 / 1.0	x2	042377
	x1	042186	
Alu	Ø 1.0 / 1.2	x2	040915
	x2	042391	
Cored wire - Fil fourré	Ø 1.2 / 1.6	x2	042391
	x1	042131	
Alu	Ø 0.9 / 1.2	x2	042407

### TYPE C

For : Neopulse - Autopulse 320-T3



Steel, Stainless steel - Acier, Inox	Ø 0.6 / 0.8	x2	041738
	Ø 0.8 / 1.0	x2	042094
Alu	Ø 1.0 / 1.2	x2	042117
	Ø 1.2 / 1.4	x2	039780
Cored wire - Fil fourré	Ø 1.2 / 1.6	x2	041752
	Ø 0.8 / 1.0	x2	042148
Alu	Ø 1.0 / 1.2	x2	042162
	Ø 1.2 / 1.6	x2	041776
Cored wire - Fil fourré	Ø 0.9 / 1.2	x2	042124

## NO GAS WELDING KIT Ø 0.9 - Kit soudage sans gaz Ø 0.9

041240

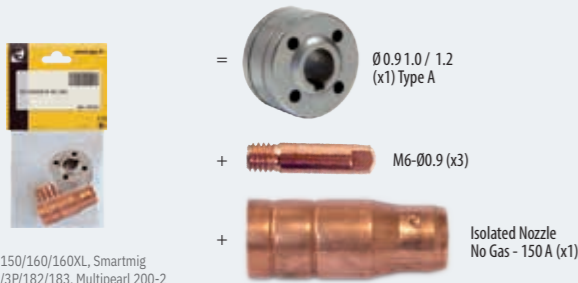

For : Easymig 150/160/160XL Smartmig 142/152/162/3P/182/183, Multiplearl 200-2

## GAS CONNECTORS - Raccords gaz - Gasanschlüsse



x2 045712

Ø 8 Ø 7 x1 046245

x1 067936

Tuyau caoutchouc - Rubber hose Ø 6.3 X 13 (EN ISO 3821)  
1.5 m 066670  
4 m 046269  
x m 046276

## SPECIAL MIG-MAG PLIER - Pince spéciale MIG/MAG - Spezial MIG/MAG Zange - Pinza especial MIG/MAG

PRO (x1) 041332

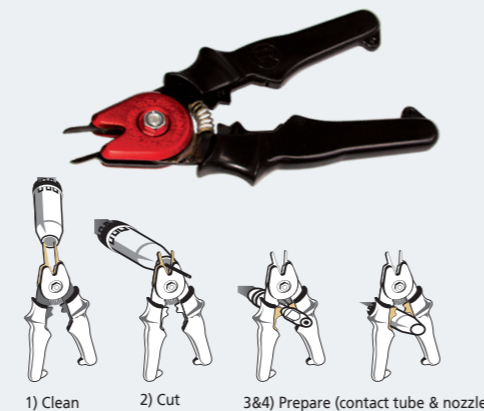

Anti-spatter spray (without silicone)  
- Spray protecteur sans silicone  
- Antihafspray (Ohne Silicon)

041806

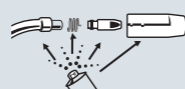

Torch gas flow-meter  
- Débitmètre de bout de torche

053939



# WELDING WIRE REELS

- Bobines de fil - Drahtrollen - Rollos de hilo - Draadbobbijn - Bobines de fio

100 mm

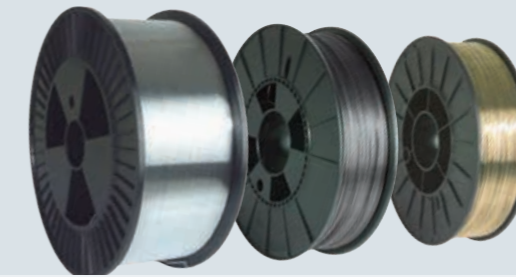

ECO  
Ecological wire reel - Bobine écologique



## STEEL - Acier - Stahl - Acero - Staal - Aço

### SG2

Norms : AWS 5.18 : ER 70S-6 ; EN ISO 14341-A : G46 4MG3S1 ; DIN 8559 : SG2

100 mm 0.9 kg	Ø 0.6	086593
	Ø 0.8	086609
200 mm 5 kg	Ø 0.6	086111
	Ø 0.8	086128
	Ø 1.0	086135
300 mm 15 kg	Ø 0.6	086166
	Ø 0.8	086227
	Ø 0.8 ECO	086272
EXCELLIUM 15 kg	Ø 1.0	086234
	Ø 1.0 ECO	086289
	Ø 1.2	086241
EXCELLIUM 15 kg	Ø 1.2 ECO	086296
	Ø 1.0 ECO	086302
EXCELLIUM 15 kg	Ø 1.2 ECO	086319

### SG1

Norms : AWS 5.18 : ER 70S-3 ; EN ISO 14341-A : G42 2MG2S1 ; DIN 8559 : SG1

200 mm 5 kg	Ø 0.6	086418
	Ø 0.8	086401

### CrMo2Si

Norms : AWS 5.28 : ER 90S-B3 ; EN ISO 2195L-A : Cr CrMo2Si

300 mm 15 kg	Ø 0.8	086258
--------------	-------	--------

### UHSS

Norms : AWS ASME SFA-5.28 : ER 120 S-G ; EN ISO 12534 : G Mn4Ni2, 5CrMo

200 mm 5 kg	Ø 0.8	086203
-------------	-------	--------

### Hardfacing - Rechargement Acier 60 HRC

Norms : EN 14700 : TZ Fe 2 ; DIN 8555 : MSG 6-CF-60

300 mm 16 kg	Ø 1.2 ECO	086173
--------------	-----------	--------

## Cored wire - Fil fourré - Fülldraht - Hilo tubular

Norms : AWS 5.20 : E71T-G5 ; EN ISO 17632-A T42 Z W N 1 H15

100 mm 0.9 kg	Ø 0.6	086425
	Ø 0.9	086104
200 mm 4.5 kg	Ø 0.9	086265
	Ø 1.0	086623
300 mm 15 kg	Ø 1.0	086630
	Ø 1.2	086388
	Ø 1.2	086395

## Galva (G2Ti)

Norms : AWS 5.18 : ER 70S-2 ; EN ISO 14341-A : G42 2 M G2Ti ; DIN 8559 : SG2

200 mm 5 kg	Ø 0.6	086760
	Ø 0.8	086777

## BRAZING - Brasage

### CuAl8 HLE - UHTS (Boron Steel)

Norms : AWS 5.7 : ER CuAl-A1 ; EN ISO 14640 : S Cu 6100 ; DIN 1733 : SG-CuAl8

200 mm 2 kg	Ø 0.8	077409
200 mm 5 kg	Ø 0.8	086661
	Ø 1.0	086197
300 mm 15 kg	Ø 1.0	086180

### CuSi3 HLE - UHTS (Boron Steel)

Norms : AWS 5.7 : ER CuSi-A ; EN ISO 14640 : S Cu 6560 ; DIN 1733 : SG-CuSi3

100 mm 1 kg	Ø 0.8	086692
200 mm 2 kg	Ø 0.8	077393
200 mm 5 kg	Ø 0.8	086647
	Ø 1.0	086654
EXCELLIUM 5 kg	Ø 0.8	086210

## STAINLESS STEEL - Inox - Edelstahl

### CrNi (316LSi)

Norms : AWS 5.9 : ER 316L Si ; EN ISO 14343-A : G19 12 3 L Si ; DIN 8556 : SG X2 CrNiMo 19 12

200 mm 5 kg	Ø 0.8	086326
	Ø 1.0	086364
300 mm 15 kg	Ø 1.0	086371

### CrNi (308LSi)

Norms : AWS 5.9 : ER 308L Si ; EN ISO 14343-A : G19 9 L Si ; DIN 8556 : SG X2CrNi 19 9

100 mm 1 kg	Ø 0.8	086616
200 mm 5 kg	Ø 0.8	086579
	Ø 1.0	086340
300 mm 15 kg	Ø 1.0	086357

## ALUMINIUM

### AlSi5

Norms : AWS 5.10 : ER 4043 ; EN ISO 18273 : S Al 4043-A ; DIN 1732 : SG-AlSi5

100 mm 0.5 kg	Ø 0.8	086685
200 mm 2 kg	Ø 1.0	086142
	Ø 1.2	086159

### AlSi12

Norms : AWS 5.10 : ER 4047 ; EN ISO 18273 : S Al 4047 ; DIN 1732 : SG-AlSi12

100 mm 0.5 kg	Ø 0.8	086678
200 mm 2 kg	Ø 0.8	077140
	Ø 1.0	086067
300 mm 7 kg	Ø 1.2	086074
	Ø 1.2	086043

### AlSi10Cu4

Norms : AWS 5.10 : ER 4145 ; EN ISO 18273 : S Al 41

200 mm 2 kg	Ø 1.2	073432
-------------	-------	--------

### AlMg5

Norms : AWS 5.10 : ER 5356 ; EN ISO 18273 : S Al 5356 ; DIN 1732 : SG-AlMg5

100 mm 0.5 kg	Ø 0.8	086548
200 mm 2 kg	Ø 0.8	086555
	Ø 1.0	086562
300 mm 7 kg	Ø 1.0	086524
EXCELLIUM 7 kg	Ø 1.2	086531
	Ø 1.0 ECO	086487
	Ø 1.2 ECO	086494

## After sales

Ø 200 & 300



Professional 71608

Ø 200 & 300



Industrial 71613

### AlMg2.7Mn

Norms : AWS 5.10 : ER 5554 ; EN ISO 18273 : S Al 5554 ; DIN 1732 : SG-AlMg

200 mm 2 kg	Ø 1.2	086517
300 mm 7 kg	Ø 1.2	086500

Thickness measurement tools (x3)  
- Jauges d'épaisseur (x3)  
- Dickenessgeräte (x3)  
071414

0.6 > 8 mm







# PLASMA CUTTING

EASYCUT K	101
EASYCUT	102
CUTTER	103



# PLASMA

COMPRESSOR INSIDE • 1~



**EASYCUT K25**

230 V • 1 ~ 25 A Fe 8 mm  
Al/CrNi 6 mm

P400 COMPRESSOR

TPT25, 4 m 068087 2 m, 10 mm<sup>2</sup>  
068063

Youtube



ULTRA LIGHT & COMPACT  
INTEGRATED AIR FILTER + AUTOMATIC DRAIN



**EASYCUT K35 PFC**

230 V • 1 ~ 35 A Fe 15 mm  
Al/CrNi 10 mm

P400 PFC AD COMPRESSOR

TPT35, 4 m 080775 2 m, 10 mm<sup>2</sup>  
080768

TPT35, 4 m 2 m, 10 mm<sup>2</sup> Box TPT35 080782 UNIVERSAL 800 051331  
080805

### OPTIONS

Consumables	Boxes - Coffrets				
for TPT25	x4 040236	x10 040212	x2 040175	x10 040168	039971
	x1	x1	x1	x1	
for TPT35	x4 040182	x10 080799	x2 040175	x10 040168	080782
	x1	x1	x1	x1	



	MADE IN FRANCE	CE NORM EN60974-1	50/60 Hz	I <sub>2</sub>	mm		INTEGRATED TECHNOLOGY					AIR SYSTEM			EN 60974-1 (40°C)			LxWxH cm / kg	Protected & compatible power generator (+/-15%)					
					Coupe max Severance cut	Coupe propre Clean cut	P400	PFC	AD	IP23	COMPRESSOR	min	ideal	max	I 60%	X% I2 max	100%		6.5 kW	7.5 kVA				
<b>EASYCUT K25</b>			230V 1~	16	10 → 25	8	6	6	4	■	—	—	—	■	included				15 A	35%	—	53 x 31 x 48 / 19	6.5 kW	7.5 kVA
<b>EASYCUT K35 PFC</b>			230V 1~	16	10 → 35	15	10	10	8	■	■	■	■	■	included				26 A	30%	—	45 x 26 x 36 / 27	8 kW	10 kVA









# INDUCTION HEATING

1 200 - 22 000 kW

GYSDUCTION	106
COMBIDUCTION	107
POWERDUCTION	108
ACCESSORIES & CONSUMABLES	112





# INDUCTION HEATING

CAR BODY

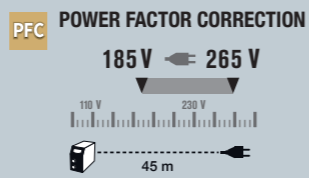

PACKS - GYSDUCTION AUTO									
	PROLINER AUTO 048775	COMPLETE AUTO 053380	COMPLETE AUTO+ 056978	MECA AUTO 048812	MECA AUTO+ 056961	BODY SHOP AUTO 048799	GLASS AUTO 048805	DENT REPAIR AUTO 054981	SMART REPAIR AUTO 079847
	✓	✓	✓	✓	✓	✓	✓	✓	✓
	✓	✓	✓	—	—	✓	✓	—	✓
	✓	✓	✓	—	—	✓	✓	—	✓
	✓	✓	✓	—	—	✓	1 box	—	✓
	✓	✓	✓	✓	✓	—	—	—	—
	✓	✓	✓	✓	✓	✓	—	—	✓
	✓	1 box	—	1 box	—	—	—	—	—
	✓	—	—	—	—	—	—	—	—
	3 boxes	—	—	—	—	✓	—	✓	—
	—	✓	—	✓	—	1 box	—	1 box	✓



**GYSDUCTION AUTO**

**2 400 W** 230 V • 1 ~

PFC AIR

CONSUMABLES

for	for	for
Protection (x5) + Colle - Stick 053854	Protection (x1) + Colle - Stick 059108	Protection (x10) + Colle - Stick 053847

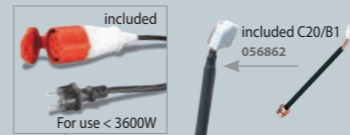

**COMBIDUCTION AUTO 50LG**

**5 200 W** 230 V • 1 ~

PFC LIQUID

065901



**INCLUDED COMBIDUCTION**

Glass - Décapage - Entfernen  
053373

Decal - Décollage - Entkleben  
053359

**OPTIONS**

Spiral inductor - Inducteur spirale - Spiralinduktor  
054783

2.5 m 1.2 kW

800 mm 054813

800 mm 054868

SIDE	Ø	⊙	Code
	18 mm	≤ M8	054806
	24 mm	≤ M12	054790
	30 mm	≤ M16	055469

Complete with - Complétez avec - Vervollständigen mit :

SIDE	Ø	⊙	Code
	21 mm	≤ M10	079953
	27 mm	≤ M14	079960

FRONT	Ø	⊙	Code
	18 mm	≤ M8	079977
	21 mm	≤ M10	079984
	24 mm	≤ M12	079991
	27 mm	≤ M14	080003
	30 mm	≤ M16	080010

PDR : Paintless Dent Repair - Débosselage sans peinture - Lackschadenfreies Ausbeulen  
054776

Licensed by BETAG innovation

3 m

Freezer spray - Spray refroidisseur  
-50 °C 400 ml (x 12) 048898

Adhesive for logo (x10) 051492

CE NORM. EN-60335/1	MADE IN FRANCE	Cable L (m)	Inductor	Heating	LxWxH cm / kg	LxWxH cm / kg	Protected & compatible power generator (+/-15%)							
								A	W	Freq. kHz	Tech. PFC	Liquid Cooling	⊙	⊙
<b>GYSDUCTION AUTO</b>		230V, 1~, 50/60 Hz	16 mini	2400	35+100	—	2	2.5	M10 → 1 s	2 mm → 5 s	Ø8 → 10 s	37 x 21 x 37 / 7.5	52 x 30 x 37 / 12.9	3 kW
<b>COMBIDUCTION AUTO 50LG</b>		230V, 1~, 50/60 Hz	25 mini	5200	20+80	71	8	3	M14 → 1 s	2 mm → 3 s 4 mm → 5 s	Ø10 → 10 s	46 x 43 x 75 / 60	v	6 kW





# INDUCTION HEATING

# 1.2 → 5.2 kW

MAINTENANCE / MECHANIC / INDUSTRY

	10R	10R PRO
POWERDUCTION 10R	✓	✓
Flexible 800 mm   054813	✓	✓
Straight 800 mm   054868	✓	✓
<b>SIDE</b>		
Ø 18 mm ⊙ ≤ M8   054806	✓	✓
Ø 21 mm ⊙ ≤ M10   079953	✓	✓
Ø 24 mm ⊙ ≤ M12   054790	✓	✓
Ø 27 mm ⊙ ≤ M14   079960	✓	✓
Ø 30 mm ⊙ ≤ M16   055469	✓	✓
<b>FRONT</b>		
Ø 18 mm ⊙ ≤ M8   079977	✓	✓
Ø 21 mm ⊙ ≤ M10   079984	✓	✓
Ø 24 mm ⊙ ≤ M12   079991	✓	✓
Ø 27 mm ⊙ ≤ M14   080003	✓	✓
Ø 30 mm ⊙ ≤ M16   080010	✓	✓



	included	37LG S90	37LG S180/B3W
S90   058927	✓	✓	—
S180/B3W   067899	—	—	✓



1200 W | 230V • 1~ | AIR

**POWERDUCTION 10R**  
(5 inductors)  
062504  
068643  
080966

**POWERDUCTION 10R PRO**  
(12 inductors)  
080195  
080300

POWERDUCTION 37LG (S90) | POWERDUCTION 37LG (S180/B3W)

**3700 W** | 230V • 1~ | \* LIQUID  
056992 | 080195 | 072510 | 080959

**3700 W** | 230V • 1~ | \* LIQUID  
083387 | 083394

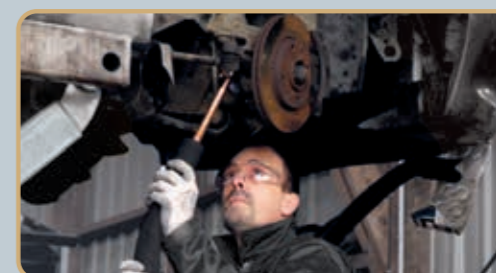
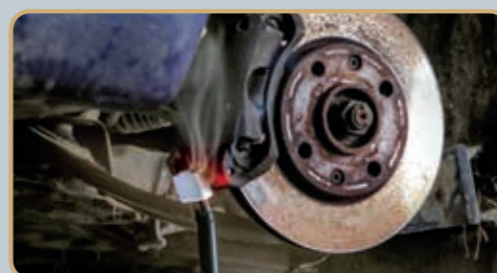
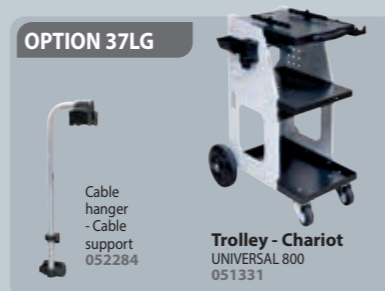
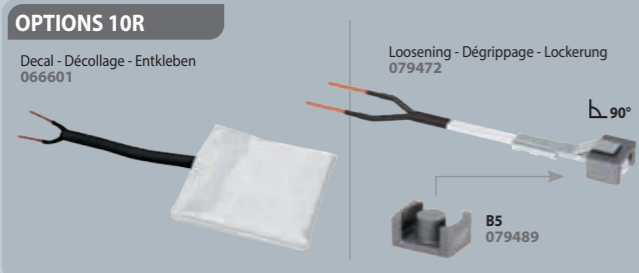

	included	39LG C20/B1	39LG S90
C20/B1   056862	✓	✓	—
28S   064485	—	—	✓
S90   058927	—	—	✓



For use < 3600W

included C20/B1 056862



READY TO USE  
Liquid included

READY TO USE  
Liquid included

POWERDUCTION 39LG (C20/B1) | POWERDUCTION 39LG (S90)

**3700 W** | 230V • 1~ | PFC \* LIQUID  
058583

**3700 W** | 230V • 1~ | PFC \* LIQUID  
080027

POWERDUCTION 50LG

**5200 W** | 230V • 1~ | PFC \* LIQUID  
055599

MADE IN FRANCE	A	W	kHz	INTEGRATED TECHNOLOGY		Liquid Cooling	Cable L (m)	Heating			Protected & compatible power generator (+/-15%)	L x W x H cm / kg	L x W x H cm / kg		
				P400	PFC			Inductor	Heating	Heating					
<b>POWERDUCTION 10R / 10R PRO</b>	230V, 1~ / 50/60 Hz	10 mini	1200	45+80	—	—	2	1.5	M10 → 1s	2 mm → 5 s	Ø8 → 10 s	1.5 kW	062504 - 42 x 17 x 37 / 5.4	062504 - 21 x 10 x 15 / 3.3	
<b>POWERDUCTION 37LG</b>	230V, 1~ / 50/60 Hz	16 mini	3700	15+30	—	—	2	2	M10 → 1s	2 mm → 5 s	Ø10 → 15 s	4 kW	60 x 34 x 33 / 14.5	56 x 26 x 29 / 13	
<b>POWERDUCTION 39LG (C20/B1) / (S90)</b>	230V, 1~ / 50/60 Hz	16 mini	3700	20+60	■	■	71	6	3	M12 → 1s	2 mm → 5 s	Ø10 → 15 s	4 kW	058583 - 81 x 38 x 59 / 52	058583 - 46 x 36 x 70 / 46.5
<b>POWERDUCTION 50LG</b>	230V, 1~ / 50/60 Hz	25 mini	5200	20+60	■	■	71	8	3	M14 → 1s	2 mm → 3 s / 4 mm → 5 s	Ø10 → 10 s	6 kW	80 x 60 x 60 / 71	46 x 43 x 75 / 58





# INDUCTION HEATING 11 → 22 kW

		110LG L90	110LG L20/B4
32L	064515	✓	✓
L90	059788	✓	—
L20/B4	067882	—	✓

NEW

		160LG L90	160LG L20/B4
32L	064515	✓	✓
L90	059788	✓	—
L20/B4	067882	—	✓

NEW



READY TO USE  
Liquid included



READY TO USE  
Liquid included



READY TO USE  
Liquid included

	<b>POWERDUCTION 110LG (L90)</b>		<b>POWERDUCTION 110LG (L20/B4)</b>
<b>11 000 W</b>	400 V • 3~	<b>11 000 W</b>	400 V • 3~
<b>* LIQUID</b>		<b>* LIQUID</b>	
058590		083400	<b>NEW</b>

	<b>POWERDUCTION 160LG (L90)</b>		<b>POWERDUCTION 160LG (L20/B4)</b>
<b>16 000 W</b>	400 V • 3~	<b>16 000 W</b>	400 V • 3~
<b>* LIQUID</b>		<b>* LIQUID</b>	
057814		083417	<b>NEW</b>

	<b>POWERDUCTION 110LG (L90) 208-240V</b>
<b>11 000 W</b>	208-240 V • 3~
<b>* LIQUID</b>	
065246	

	<b>POWERDUCTION 160LG (L20/B4) 208-240 V</b>
<b>16 000 W</b>	208-240 V • 3~
<b>* LIQUID</b>	
065253	

### OPTIONS



Removable handle  
- Poignée de lance  
- Abnehmbarer Griff  
for POWERDUCTION  
110 - 160 - 220 LG  
068599



**Cooling liquid  
for  
POWERDUCTION**  
2 L 082212  
5 L 062511  
10 L 052246



Protection cover  
- Housse de protection  
- Schutzhaube  
for  
POWERDUCTION  
160 - 220 LG  
050853



Protection cover  
- Housse de protection  
- Schutzhaube  
for  
POWERDUCTION  
110LG  
062733



055490

### OPTION



**Powerduction  
160/220 LG over  
hanging arm-  
pulley**  
- Équilibrer  
Powerduction  
160/220 LG

079441

### t° POWER HEAT CONTROLLER



**t° CONTROL**  
80>350°C (210>660°F)

5,5m

**POWER HEAT  
CONTROLLER**  
061644



Included  
T° sensors  
thermocouple type K  
x2

**Compatibility**  
POWERDUCTION 110LG  
POWERDUCTION 110LG 208-240 V  
POWERDUCTION 160LG  
POWERDUCTION 160LG 208-240 V  
POWERDUCTION 220LG

### OPTION



**Pyrometer IR**  
for inductor L90

1.1 m  
064119

MADE IN FRANCE	Cable L (m)	Freq.	Liquid Cooling	Cable L (m)	Heating	LxWxH cm / kg	LxWxH cm / kg	Protected & compatible power generator (+/-15%)					
									A	W	kHz	Inductor	Inductor
<b>POWERDUCTION 110LG</b>	400 V, 3~, 50/60 Hz	16 mini	11 000	20+60	71	5	4	M18 → 1 s	2 mm → 2 s 4 mm → 4 s	Ø10 → 7 s	42 x 42 x 76 / 66.5	59 x 80 x 60 / 86	15 kW
<b>POWERDUCTION 110LG 208-240V</b>	208-240 V, 3~, 50/60 Hz	35 mini	11 000	20+60	71	5	4	M18 → 1 s	2 mm → 2 s 4 mm → 4 s	Ø10 → 7 s	42 x 42 x 76 / 78	59 x 80 x 60 / 90	15 kW
<b>POWERDUCTION 160LG</b>	400 V, 3~, 50/60 Hz	32 mini	16 000	20+60	301	4	6	M20 → 1 s	2 mm → 2 s 4 mm → 4 s	Ø10 → 5 s	78 x 58 x 118 / 128	80 x 61 x 120 / 140	22 kW
<b>POWERDUCTION 160LG 208-240V</b>	208-240 V, 3~, 50/60 Hz	45 mini	16 000	20+60	301	4	6	M20 → 1 s	2 mm → 2 s 4 mm → 4 s	Ø10 → 5 s	78 x 58 x 118 / 113.5	80 x 60 x 120 / 126	22 kW
<b>POWERDUCTION 220LG</b>	400 V, 3~, 50/60 Hz	32 mini	22 000	20+60	301	4	6	M45 → 3 s	4 mm → 3 s 8 mm → 9 s	Ø10 → 4 s	70 x 60 x 120 / 98	80 x 60 x 132 / 139	22 kW
<b>POWERDUCTION 220LG 10M</b>	400 V, 3~, 50/60 Hz	32 mini	22 000	20+60	301	4	10	M45 → 3 s	8 mm → 9 s 4 mm → 3 s	Ø10 → 4 s	70 x 60 x 120 / 132.5	80 x 60 x 120 / 144.5	22 kW



# SMALL Ø16

## INDUCTORS

* = original equipment	S90 058927	S70 061569	S180 059269	S20/B1 (20°) 064874	S180/B1 064881	S180/B3W 067899
37 LG	✓*		✓			✓
39 & 50 LG			✓ with adapter 28S			
110, 160 & 220 LG			✓ with adapter 32S			

	S20/D20 078796	S90/D20 078871	S180/D20 069985
Ø 20	S20/D25 078802	S90/D25 078888	S180/D25 069992
Ø 25	S20/D30 078819	S90/D30 078895	S180/D30 070592
Ø 30	S20/D35 078826	S90/D35 078901	S180/D35 070608
Ø 35	S20/D40 078833	S90/D40 078918	S180/D40 070615
Ø 40	S20/D45 078840	S90/D45 078925	S180/D45 070622
Ø 45	S20/D50 078857	S90/D50 078932	S180/D50 070639
Ø 50	S20/D55 078864	S90/D55 078949	S180/D55 070646
Ø 55			
37 LG	✓ S20/D20-D35, S90/D20-D35, S180/D20-D35		
39 & 50 LG	✓ with adapter 28S		
110, 160 & 220 LG	✓ with adapter 32S		
Protection kit for L180/D inductors - Kit de protection pour inducteurs boucle 077386			

	S180 HEAT TUBE D37 078604	S180 HEAT TUBE D40 078611	S180 HEAT TUBE D50 078628
39 & 50 LG	✓ with adapter 28S		
110, 160 & 220 LG	✓ with adapter 32S		

DIFFICULT ACCESS ADAPTERS	
	<ul style="list-style-type: none"> <li>90°-S 082663</li> <li>✓ compatible with 180/B1</li> <li>✓ compatible with 180/B2</li> <li>✓ compatible with 180/B3W</li> </ul>

ADAPTERS	
	<ul style="list-style-type: none"> <li>28S M28 Ø16 064485</li> <li>32S M32 Ø16 064508</li> </ul>
39 & 50 LG	✓ 28S M28 Ø16
110, 160 & 220 LG	✓ 32S M32 Ø16

Boxes - Boîtes		
 <b>28S/B type W</b> for 39LG & 50LG 072497 included: S20/B1 (x1) S180/B1 (x1) S180/B3 (x1) 28S (x1) B1 (x1) B3 (x1)	 <b>32S/B type W</b> for 110LG, 160LG & 220LG 072503 included: S20/B1 (x1) S180/B1 (x1) S180/B3 (x1) 32S (x1) B1 (x1) B3 (x1)	 <b>L box</b> 065796 included: L70 (x1) L180 (x1)

<b>Trolley for inductor for adapter 32L</b> Chariot pour inducteur pour adaptateur 32L 075955  4 to 8 wheels
--

Ferrites - Ferrites - Ferritaufsatz										
 B1 053823	 B1 (x5) 079380	 B2 053458	 B3 067875	 B4 053755	 B5 079489	 B1 (x5) 079397	 B2 056916	 B3 072527	 B4 054844	 Spiral 069701

<b>Glue kit for inductor</b> Kit de colle pour inducteur 075948  EA 9487 Colle-Stick bi-composants Power Epoxy 150°C 054851
--

# LARGE Ø32

## INDUCTORS

* = original equipment	L90 (90°) 059788	L70 (70°) 059771	L180 059795	L180/Spiral 065000	L20/B4 067882	L180/B4 079786	L20 Alu Glove 069114
39 & 50 LG			✓ with adapter 28L	✓ with adapter 28L			
110, 160 & 220 LG	✓ with adapter 32L*		✓ with adapter 32L		✓ with adapter 32L*	✓ with adapter 32L	✓ with adapter 32L

Ø	Pre-heating - Préchauffe Heating - Chauffage	Pre-heating & Fretting - Préchauffage et Frettage		
Ø 60	✓	L20/D60 078956	L90/D60 079106	L180/D60 069923
Ø 70	✓	L20/D70 078963	L90/D70 079113	L180/D70 069930
Ø 80	✓	L20/D80 078970	L90/D80 079120	L180/D80 069121
Ø 90	✓	L20/D90 078987	L90/D90 079137	L180/D90 069947
Ø 100	✓	L20/D100 078994	L90/D100 079144	L180/D100 069954
Ø 110	✓	L20/D110 079007	L90/D110 079151	L180/D110 069961
Ø 120	✓	L20/D120 079014	L90/D120 079168	L180/D120 069978
Ø 130	✓	L20/D130 079021	L90/D130 079175	
Ø 140	✓	L20/D140 079038	L90/D140 079182	
Ø 150	✓	L20/D150 079045	L90/D150 079199	
Ø 160	✓	L20/D160 079052	L90/D160 079205	Production on request
Ø 170	✓	L20/D170 079069	L90/D170 079212	
Ø 180	✓	L20/D180 079076	L90/D180 079229	
Ø 190	✓	L20/D190 079083	L90/D190 079236	
Ø 200	✓	L20/D200 079090	L90/D200 079243	
39 & 50 LG		✓ with adapter 28L		
110, 160 & 220 LG		✓ with adapter 32L		

Protection kit for L180/D inductors - Kit de protection pour inducteurs boucle 077386	
--	--

ADAPTERS	 28L M28 Ø32 064492	 32L M32 Ø32 064515
39 & 50 LG	✓ 28L M28 Ø32	
110, 160 & 220 LG	✓ 32L M32 Ø32	

Pre-heating & Fretting - Préchauffage et Frettage			
> Ø 200 & < Ø 300	Production on request		
110, 160 & 220 LG	✓ with adapter 32L		

Brasing - Brasage			
* = original equipment	L90 BRAZ 16 Ø 1/2" / 16 mm 076907	L90 BRAZ 28 Ø 1" / 28 mm 076921	L180 BRAZ 16 Ø 1/2" / 16 mm 076914
			L180 BRAZ 28 Ø 1" / 28 mm 076938
110, 160 & 220 LG	✓ with adapter 32L*		

Protection kit for BRAZ inductors - Kit de protection pour inducteurs brasage 077515	
---	--

Exchanger - Échangeur	
	L180R X Production on request
110, 160 & 220 LG	✓ with adapter 32L

# COMPLETE Ø28

## INDUCTORS

	C20/B1 056862	C180/B1 056879	C180/B2 056886
37 LG			
39 & 50 LG	✓*		✓
110, 160 & 220 LG			





# TRUCK TOOLS & MOBILE LIFTS

## TRUCK TOOLS

TROLLEY IW1	115
MULTITOOL TRUCK	115

## CAR LIFTS

	SPOT LIFT	116
<b>NEW</b>	QUICK LIFT / AIR JACKS	118
	ERGO LIFT	119
<b>NEW</b>	MANUAL DOOR LIFT / WHEEL LIFT	120



TROLLEY IW1 / MULTITOOL TRUCK

# TRUCK TOOLS

**TROLLEY IW1**  
Impact wrench trolley -  
Support de clé à choc

max 6.5 bar

**max 20 kg**

063136



Youtube

### OPTIONS



Huile hydraulique  
- Hydraulic oil  
1l  
053397

**Weight, vibrations  
& torque suppression -  
Suppression du poids,  
des vibrations et du couple**

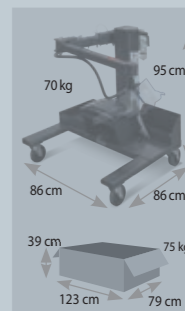

Impact wrench -  
Clé à choc  
**max 20 kg**

Fixation  
36 x 36 mm  
→ 44 x 44 mm

Weight adjust  
- Effort réglable

**High maneuverability & stability -  
Grande maniabilité et stabilité**



**High dexterity -  
Liberté de mouvement**

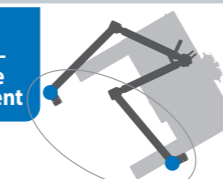

115

TRUCK TOOLS



## MULTITOOL TRUCK

**SAFE EN 14238 + A1**

**max 200 kg**

067158

### INCLUDED



Lifting tool for brake caliper  
- Outil de levage pour étrier  
de frein - Hebewerkzeug für  
Bremssattel



Brake caliper



Lifting tool for battery -  
Outil de levage pour batterie  
- Hebewerkzeug für Batterie

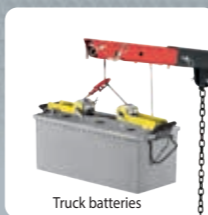

Truck batteries



Lifting tool for wheels -  
Outil de levage pour roues  
- Hebewerkzeug für Räder

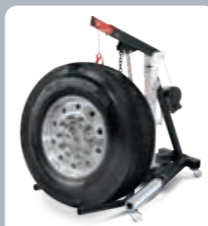

**SAFE  
EN 14238 + A1**

**ULTRA  
COMPACT  
103 cm**

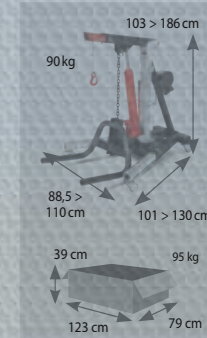

### HEALTH CARE

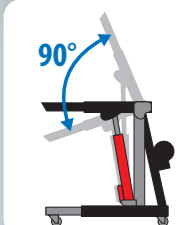





# SPOT LIFT

## MOBILE LIFTS

### SPOT LIFT EASY

max Air 8 bar **SAFE EN 1494**  
**max 2.2 t**

#### HEALTH CARE



#### High stability - Haute stabilité



Included  
220 bar  
053588

**SAFE EN 1494**

#### SECURITY



#### OPTIONS

Hydraulic oil 1L  
- Huile hydraulique  
1L  
053397

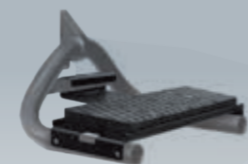

Rocker panel lifting tool  
- Outil de levage pour bas de caisse  
- Auflage für Seitenschweller  
053236



### SPOT LIFT PRO

max Air 8 bar **SAFE EN 1494**  
**max 2.2 t**

053557

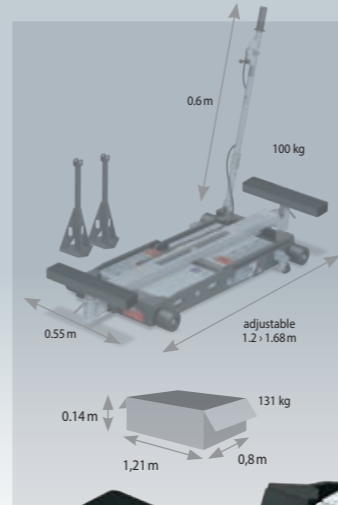

### SPOT LIFT PRO MOB

max Air 8 bar **SAFE EN 1494**  
**max 2.2 t**

055896



**60 cm (max)**  
14 cm (min)

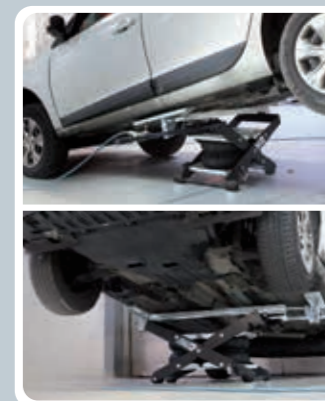

#### OPTIONS

Height adjuster for 4x4 & utility vehicles  
- Réhausseur pour 4x4 et utilitaires  
- Erhöhung f. 4x4 und Leicht-LKW



Pads - Patins for Audi & BMW (x 2)  
053717

Ramps - Ramps 700 x 200 x 80 mm (x 2)  
056787



#### OPTIONS

SPOT LIFT PRO MOB  
Réhausseur pour 4x4 et utilitaires  
- Height adjuster for 4x4 & utility vehicles  
- Erhöhung f. 4x4 und Leicht-LKW



Patins - Pads for Audi & BMW (x 2)  
061606

Ramps - Ramps 700 x 200 x 80 mm (x 2)  
056787

#### AUTO ROLL

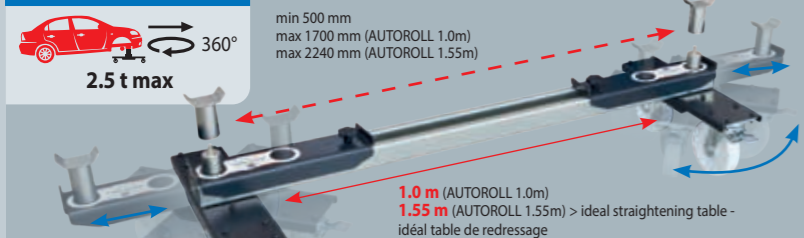

AUTO ROLL 1.0 m / 1.2 t  
059047



AUTO ROLL 1.55 m / 1.2 t  
063839



#### AFTER LIFT AUTO ROLL

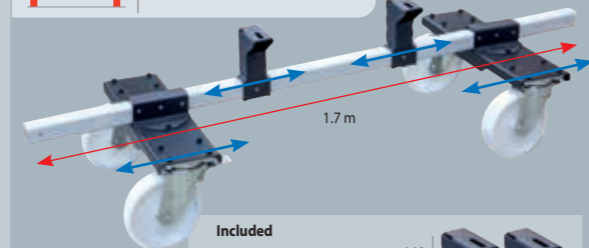
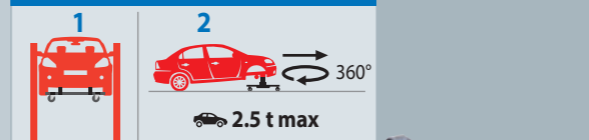

067967



#### WHEEL TROLLEYS - Tabourets de manutention - Radhocker

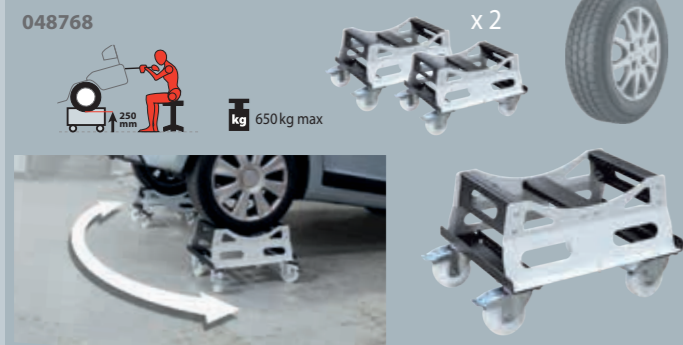

#### MECHANICAL LIFTING JACKS - Chariots de manutention prise sous roue - Kfz-Montagelift, fahrbar

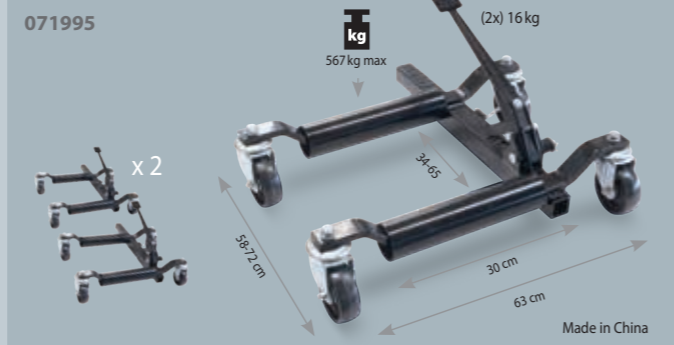



**QUICK LIFT L520E**

062184

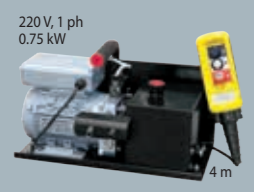

220 V, 1 ph  
0.75 kW

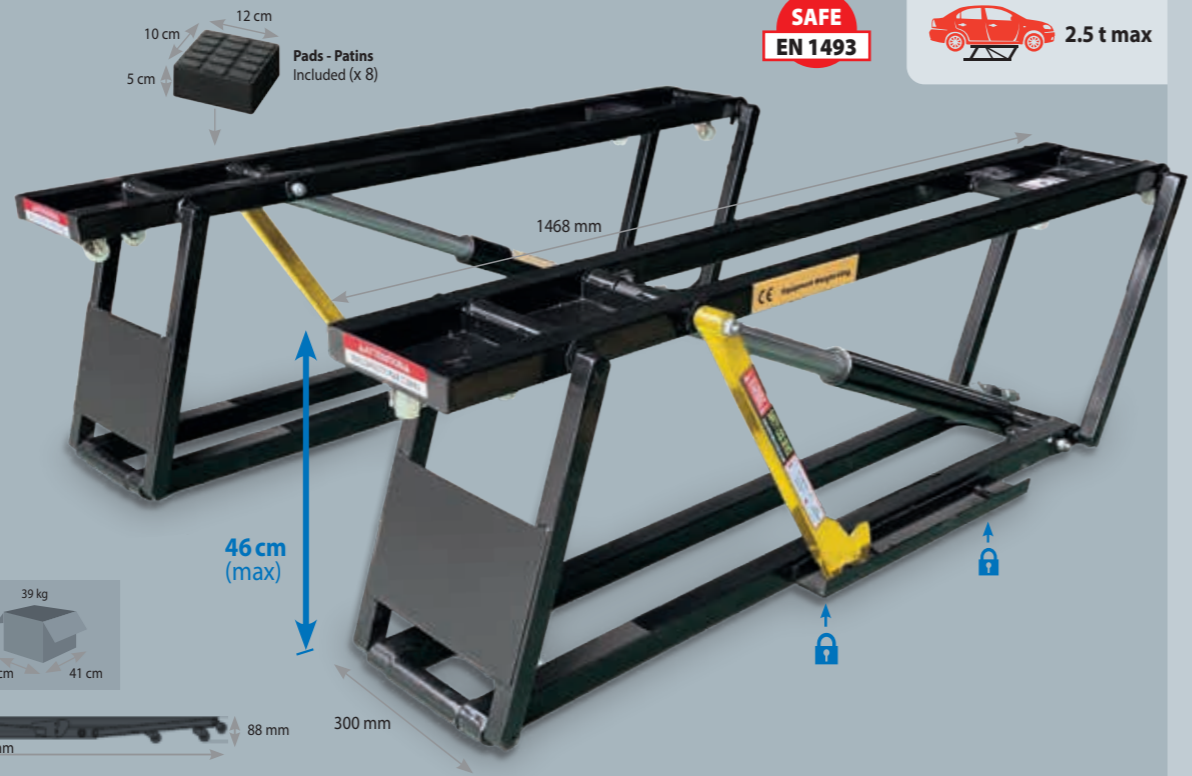

**SAFE EN 1493** 2.5 t max

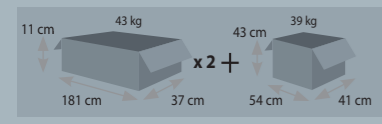
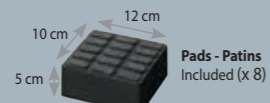

**OPTIONS**

- Extensions 1680 mm x 2 (066328)
- x4 Patins à rainures (071933)
- Pads for SUV x4 - Patins pour SUV x 4 (065017)
- Wall mount - Support mural (071926)

**ERGO LIFT 1000 ROLL**

Air 7-8 bars **SAFE EN 1493**

max 2.5 t



**SAFE EN 1493**

Handle for adjusting the automatic locking support arms - Poignée de positionnement des bras porteurs avec verrouillage automatique

included: (x4) 4 cm + (x4) 6 cm

95 cm (max)

30 cm x 23 kg x 49 cm x 37 cm (Wheels)

Wheel kit (076778) x 4

Pump included (082977) 29 cm x 8.7 kg x 38 cm x 18 cm

Easy connection

Hydraulic Safety

Security 100%

**AIR JACKS**

**DOUBLE BAG AIR JACK 082878**

Pressure: 8 bar (116 PSI)  
Weight 12 kg

60 x 52 x 14.5 cm  
14.8 kg

**SAFE EN 1494**

12 kg  
LIGHT & COMPACT

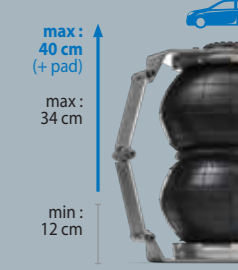
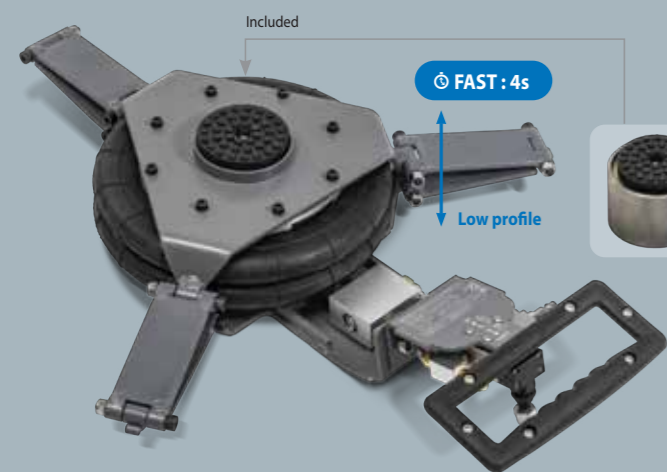

**NEW 06/2024**

**TRIPLE BAG AIR JACK 082885**

Pressure: 8 bar (116 PSI)  
Weight 14 kg

62 x 56.5 x 18 cm  
17.8 kg

**SAFE EN 1494**

14 kg  
LIGHT & COMPACT

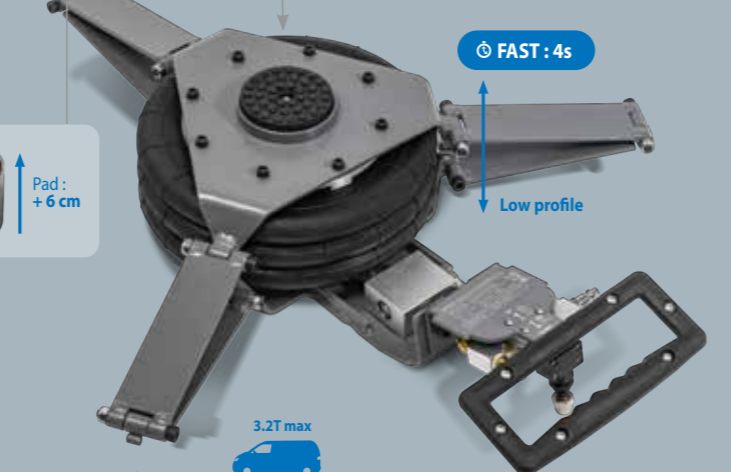

**NEW 06/2024**

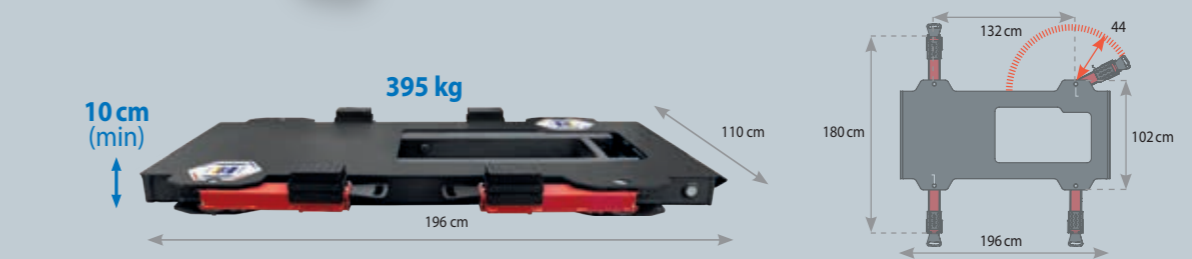

**OPTIONS**

- Pads for SUV x4 - Patins pour SUV x 4 (065017)
- Ergo Lift ramps x2 - Rampes Ergo Lift x2 (082717) Capacity: max 3.5 t
- Pack ERGO LIFT 1000 ROLL + wheels (076792)
- Pack ERGO LIFT 1000 ROLL + wheels + ramps (082984)



## MANUAL DOOR LIFT

Ergonomic door handling trolley  
 - Support Pro ergonomique de manutention de portière  
 - Ergonomische Türhandhabungsunterstützung  
 082670

**GYS** Manufactured by GYS = SUPER PRO

117 x 28 x 27 cm  
 40 kg

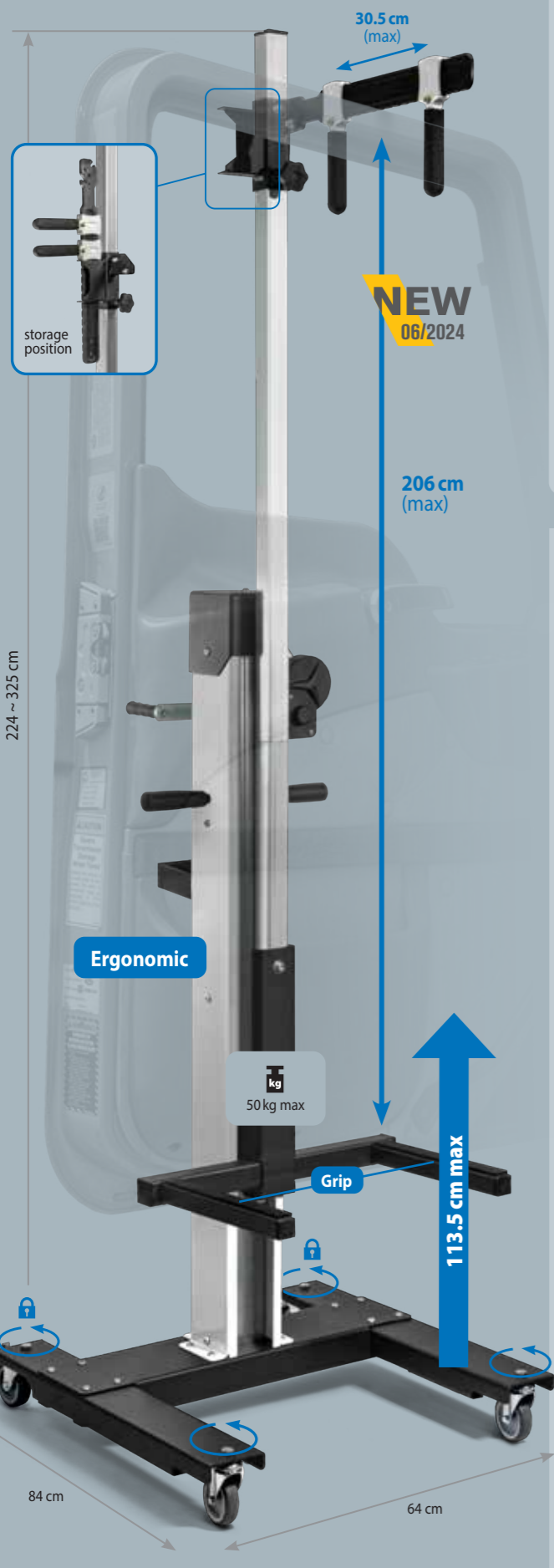

## Option

Wide door accessory  
 - Accessoire pour portière large  
 - breites Türzubehör  
 082700

**NEW**



## MANUAL WHEEL LIFT

Wheel lift trolley  
 - Lève roue à treuil  
 - Radmontage-Heber  
 061385

**GYS** Manufactured by GYS = SUPER PRO

min: R13 / 135 / 65  
 max: R22 / 300 / 35  
 40 kg max

117 x 28 x 27 cm  
 42 kg

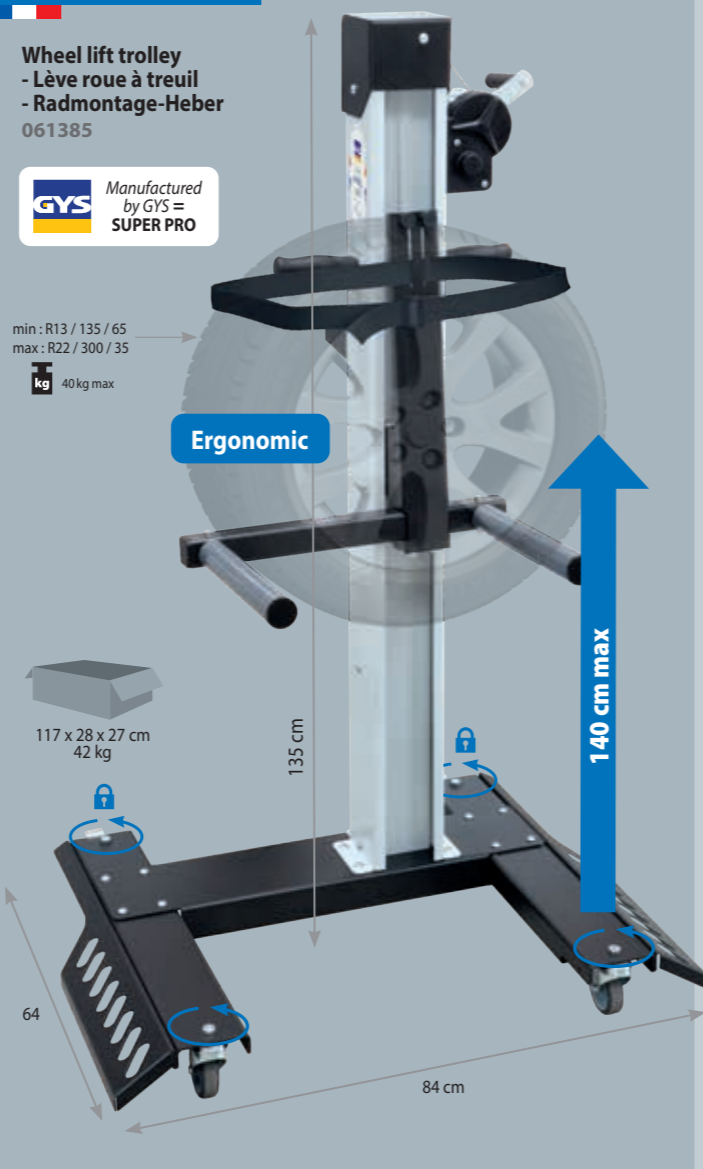

+

# ACCESSORIES

WELDING HELMETS	122
FUME EXTRACTION	125
WINDSCREEN REPAIR	126
BUMPER REPAIR	128
HAND TOOLS	130
PNEUMATIC TOOLS	134
WORKING LIGHTS	136
SANDING & DUST EXTRACTION	138
WORKING SUPPORTS	140
ELECTRIC VEHICLES	144
SAFETY PROTECTION	146



# HELMETS TECHNOLOGIES

## Teinte initiale - Initial shade

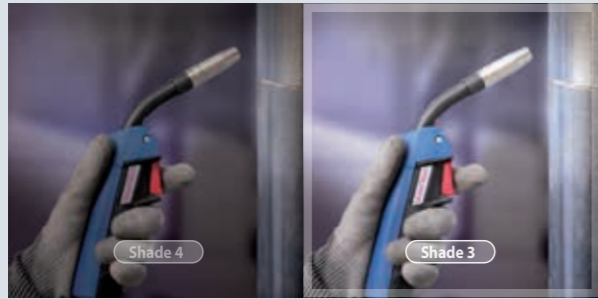

Classic

ULTRA CLEAR

## Spectre de couleur - Spectrum view

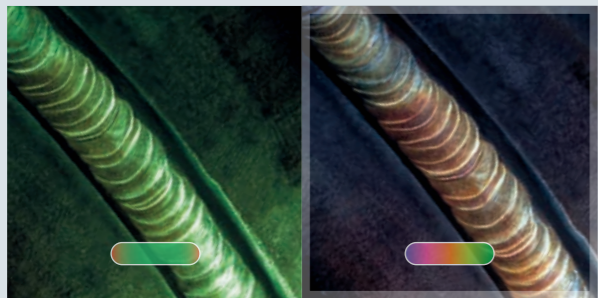

Classic

TRUECOLOR

## Classification - X=/X=/X=/X=

1/1/1/1 = PERFECT QUALITY

(1) Optical quality (distortion). (2) Light diffusion (contrast). (3) Variation of light transmission (homogeneities of the dark shade). (4) Angular light (diagonal light ray filter).

(1) Qualité optique (distorsion). (2) Diffusion de la lumière (contraste). (3) Variation de la transmission lumineuse (homogénéités de la teinte foncée). (4) Lumière angulaire (filtre de rayons lumineux diagonaux).

## Headgear - Serre-tête



Simple

Multi

Multi Pro

Multi Premium

Comfortable back

## WELDING HELMETS

# 9-13

IDEAL



GYSMATIC 9-13 G  
043909



◀ 100 x 60 mm | □→■ 0.08 ms

GRIND + (1/1/1) x 4 TRUECOLOR

## WELDING HELMETS

# 5-9/9-13



Multi Premium



ALIEN XXL +  
068698



◀ 100 x 93 mm

□→■ 0.08 ms

GRIND + (1/1/1) x 4 ULTRA CLEAR 3 TRUECOLOR

Body repair recommended



Multi Premium



GYSMATIC AUTO PRO  
082809

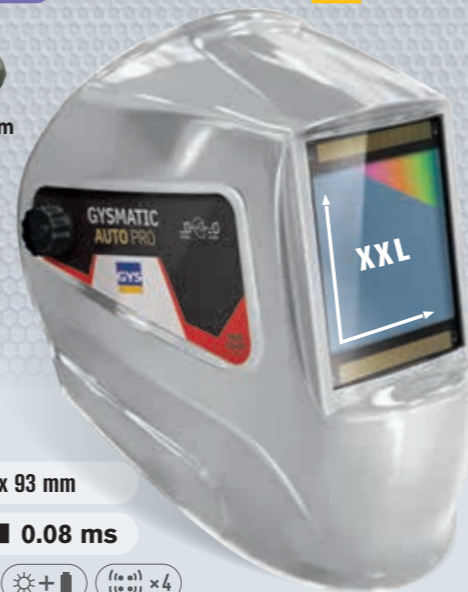

◀ 100 x 93 mm

□→■ 0.08 ms

GRIND + (1/1/1) x 4 CLASS 1/1/1/1 ULTRA CLEAR 3 TRUECOLOR

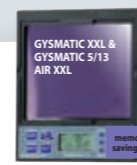

GYSMATIC XXL & GYSMATIC 5/13 AIR XXL

DIGITAL MEMORY & REGULATIONS ELECTRONIC



Multi Pro



GYSMATIC 5-13 G XXL  
037236



◀ 100 x 93 mm

□→■ 0.04 ms

GRIND + (1/1/1) x 5 ULTRA CLEAR 2 DIGITAL TRUECOLOR

COMING SOON

# PANORAMIC

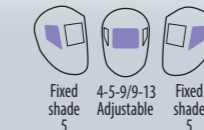

Fixed shade 5

4-5-9/9-13 Adjustable

Fixed shade 5



APOLLO + 3/5-13 G  
068681



◀ 100 x 67 mm

□→■ 0.08 ms

GRIND + (1/1/1) x 4 PANORAMIC CLASS 1/1/1/1 ULTRA CLEAR 3 TRUECOLOR



Multi Premium



Shade 3-10

3-4-8/8-12 Adjustable

Shade 3-10



PANORAMIC 3XL  
037281



◀ 114 x 85 mm

□→■ 0.04 ms

GRIND + (1/1/1) x 4 PANORAMIC ULTRA CLEAR 3 CLASS 1/1/1/1 ULTRA CLEAR 3 TRUECOLOR



Carry bag for helmet welding - Sac pour masque de soudage  
043299



066656



Antiperspirant-headband - Bandeau anti-transpiration  
043466 for Multi Premium, Multi Premium Pro, Multi, Simple  
062627 for Multi Pro  
070844 for Gysmatic 9/13 Air, Gysmatic 5/13 Air XXL



Magnifying glass - Loupe for Zeus, Ergotech & Alien True Color  
x1  
zoom x2 042780  
zoom x3 064140

## LENSES - Verres - Schutzgläser

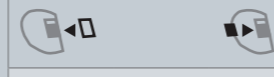
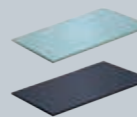

Model	Code	Dimensions	Code
GYSMATIC 9-13 G	043893	G: 106 x 66 (x10)	043886
GYSMATIC ALIEN XXL + GYSMATIC AUTO PRO	043893	104 x 96 (x5)	043596
GYSMATIC 5-13 G XXL	043893	106 x 89,5 (x10)	046825
APOLLO + 3/5-13 G	043893	103.7 x 69.5 (x5)	077102
PANORAMIC 3XL	037311	special kit (x1)	037304

Model	Shade	Response Time	Grind	Class	Optics	Weight	Mask Brand
GYSMATIC 9-13 G	4-9>13	0.08 ms	GRIND	1/1/1/1	XL: 100x60 mm	580 g	Gys
GYSMATIC ALIEN XXL + GYSMATIC AUTO PRO	3-5>9/9>13	0.08 ms	GRIND	1/1/1/1	XXL: 100x93 mm	540 g	Gys
GYSMATIC 5-13 G XXL	2-4>9/9>12	0.04 ms	GRIND	1/1/1/2	XXL: 100x93 mm	550 g	Gys
APOLLO + 3/5-13 G	3-5>9/9>13 + 2x: 5	0.08 ms	GRIND	1/1/1/1	XL: 100x67 + 2x103.7x69.5 mm	585 g	Gys
PANORAMIC 3XL	3-4>8/8>12 + 2x: 3>10	0.04 ms	GRIND	1/1/1/1	114x85 + 2x(68x80) mm	610 g	Gys



# HELMETS VENTILATED

IDEAL



DIGITAL MEMORY & REGULATIONS ELECTRONIC



**GYSMATIC 3/9-13 G AIR**  
0465727  
069602

100 x 60 mm

0.08 ms



**GYSMATIC 5-13 G AIR XXL**  
047846  
028852

100 x 83 mm

0.1 ms



included with GYSMATIC 5/13 G AIR XXL

**Filtration class EN 12941: TH2 P R SL**  
Air 165 / 200  
220 L/min  
Battery included

OPTION Filter TH3  
065734



Battery charger  
037472  
028869



Battery included  
037465



038424 x1



038417 x5

LENSES - Verres - Schutzgläser

			TRUE COLOR	HF	DELAY								L x W x H cm / g	MASK BRAND
114 x 133 (x10)	043893	G: 106 x 66 (x10)	043886	GYSMATIC 3/9-13 G AIR	3-9>13	0.08 ms	✓	0.10>0.90 s	1/1/1/2	4 HIGH SENSITIVITY	XL: 100x60 mm	✓	28 x 25 x 28 / 1230	Gys
114 x 133 (x10)	043893	106 x 89,5 (x10)	046825	GYSMATIC 5-13 G AIR XXL	4-5>9 / 9>13	0.10 ms	✓	0.1 > 0.9 s	1/1/1/1	4 HIGH SENSITIVITY	XXL: 100x83 mm	✓	27 x 25 x 28 / 1000	Gys

## FUME EXTRACTION SYSTEMS - Aspirateurs de fumée - Rauchgasabsauggerät

UNI 2.0 RE

- 400V 3~
- 50 Hz
- 1100 W
- 1500 m<sup>3</sup>/h max
- arm 3 m
- no plug
- 100 kg
- extraction 0.5 m/s

122 x 67 x 145 cm / 111.5 kg

061545



Ø 150 mm

Included  
Pré filtre, treillis Aluminium  
Class of filtration G3 EN 779  
+ Filtre - Coal Filter EPA E12  
EN 779, Filtration >99.5 %  
046467

Options  
Filtre à charbon actif -  
Coal filter  
✓ UNI 2.0 RE  
064522

EVO 2.1 RE

- 230V 1~
- 50 Hz
- 1100 W
- 1200 m<sup>3</sup>/h max
- occasional
- arm 3 m
- included
- 85 kg

96 x 95 x 162 cm / 114 kg

061552



Ø 150 mm

Patented - Breveté

792 mm

347 mm

Included  
Pré filtre, treillis Aluminium  
Class of filtration F15 G2 EN 779  
+ Filtre - Coal Filter HEPA H13  
EN 779, Filtration >99.95%  
046498

## FUME EXTRACTION TORCHES - Torches aspirantes - Rauchgas-Absaugbrenner - Antorcha con aspiración de humos



BINZEL

	Steel/Stainless steel - Acier/Inox - Stahl/Edelstahl			
	AIR		LIQUID	
	150 A	250 A	350 A	500 A
original equipment	M6	M6	M8	M8
Ø	Ø 0.8	Ø 1.0	Ø 1.2	Ø 1.2
X % 40°C - ArCO <sub>2</sub>	150A - 60%	200A - 60%	290A - 60%	380A - 100%
GRIP	GRIP	GRIP	GRIP	GRIP
L	3m	3m	4m	4m
Ref.	043251	040540	040557	040564

For fume Extraction Torches - Pour torches aspirantes

BINZEL  
073715



- 230V / 1 ~, 1100 W
- 230 m<sup>3</sup>/h max
- 190 mbar max
- 25 kg, 590 x 425 x 825 mm
- 76 db
- Filter auto cleaning system - Système de nettoyage automatique du filtre - Automatische Filterabreinigung

Filtre Classe M, EN 60335-2-69

included: 5 m, Ø50

• External evacuation Ø50 (hose not included)  
• Évacuation extérieure Ø50 (tuyau non inclus)

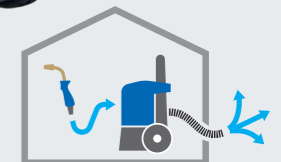



**PROFESSIONAL BOX SET FOR WINDSCREEN REMOVAL** - Coffret de découpe pare-brise  
- Frontscheiben-Trennsystem für Akkuschrauberbetrieb

057654

included  
Axe enrouleur  
068100

included  
65 m  
resistance 170 kg  
Ø 0.79 mm  
058125

optional  
65 m  
resistance 190 kg  
Ø 0.92 mm  
069275

MADE IN HIGH QUALITY GERMANY

**OSCILLATING PNEUMATIC SAW FOR WINDSCREEN REMOVAL** - Couteau pneumatique de découpe pare-brise  
- Druckluft-Trennmesser für Windschutzscheiben

057623

Included  
57 mm  
057845

90 mm  
057852

8 mm  
057876

35 mm  
057838

U  
36 mm  
057869

**REMOVAL TOOL FOR WINDSCREEN WIPER ARMS** - Extracteur d'essuie-glace - Wischerarm-Abzieher

UNIVERSEL  
057630

30 mm max

EXPERT  
Accès difficile  
- Difficult access  
057647

40 mm max

**WINDSHIELD CUTTING KIT** - Système de découpe pare-brise à cliquet  
- Set zum Lösen von Windschutzscheiben

054738

**DASHBOARD PROTECTOR** - Protections tableau de bord  
- Armaturenbrett Schutz

053120

45 cm

27 cm

45 cm

27 cm

**SUCTION LIFTING PADS** - Ventouses - Saugnapfwerkzeug für Spiegelgläser

056695

Ø 70 mm

051966

x2

x6  
057609

**WINDSHIELD CUTTING TOOL** - Outil découpe pare-brise  
- Windschutzscheiben Demontage-Set

051935

**WINDSCREEN JOINT-CUTTING KIT** - Kit découpe joint de pare-brise - Scheibentrenn-Werkzeug-Set

051898

051911

051881

Corde à piano torsadé (22 m)  
- Windscreen seal cutting wire (twisted)  
- Piano-Schneiddraht, gedreht, 22 m Rolle

Corde à piano carré (50m)  
- Windscreen seal cutting wire (square)  
- Vierkant-Draht, 50 m Rolle

**COMPRESSED AIR POLISHER** - Renov'Polycarbonate - Druckluftpolierer

Complete pack

1 orbital sander  
+ 1 polisher  
- 1 ponceuse orbitale  
+ 1 lustreuse

052086

2 SPEED

052055

052062

052079

sander Ø75  
057494

polisher Ø75  
058224

Ø 76

P 500 (x 10)  
P 800 (x 10)  
P 1500 (x 10)  
P 3000 (x 10)

P 500 x 50 052017  
P 800 x 50 052024  
P 1500 x 50 052031  
P 3000 x 50 052048



**HOT STAPLER FOR BUMPER REPAIR** - Agrafeuse pour réparation pare-chocs - Stoßstangen Reparatur Kit

052925

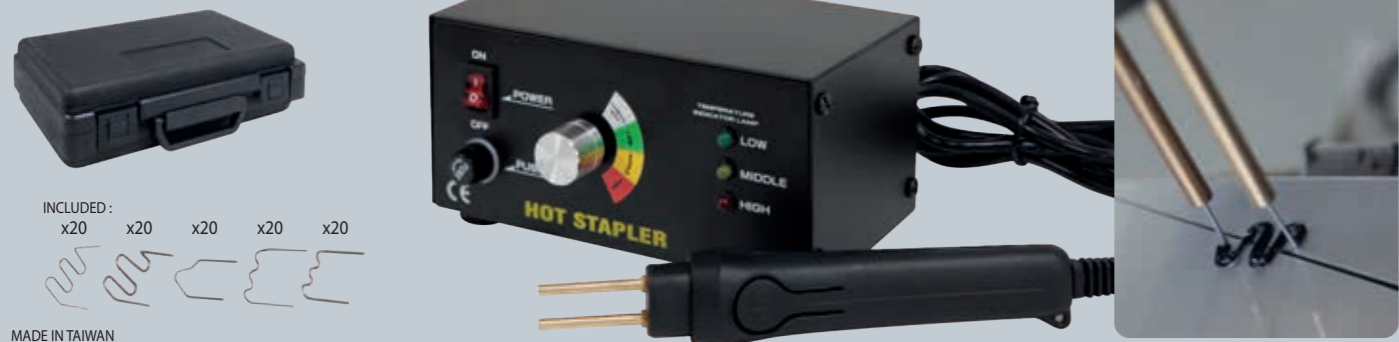

INCLUDED:  
x20 x20 x20 x20 x20

MADE IN TAIWAN

**PORTABLE**  
Battery operated - Sur batterie  
058118

included  
Li-ion battery 3.7V  
048669  
included adapters:  
EUR, UK, USA & AUS

Charger included  
048652

MADE IN TAIWAN



INCLUDED:  
Ø 0.6, x100 Ø 0.8, x100  
Ø 0.6, x100

Staples - Agrafes	V	U	N	W	M
	Inside corner - Angle interne étroit Ø 0.7 mm	Crack alignment - Alignement de fissure Ø 0.7 mm	Large crack - Fissure importante Ø 0.7 mm	Internal angle - Angle interne Ø 0.7 mm	External angle - Angle externe Ø 0.7 mm
	x 100 047990	x 100 047983	x 100 047976	x 100 047969	x 100 047952
052413	= x 50	+ x 50	+ x 50	+ x 50	+ x 50

**PIERCING KIT FOR BUMPER SENSORS** - Coffret de perçage pare-chocs pour détecteurs - Lochwerkzeug für Stoßfänger



**PRO +**  
059139

Ø 17-18-18,2  
19-20-22,5-24  
26-26,7-32 mm



**FREEZER**

Freezer spray  
- Spray refroidisseur

-50 °C

400 ml

(x 12)  
048898



**TOOL FOR REMOVING BUMPER** - Outil de déclipsage pare-chocs



076518



x15  
076525

**HAND SEAMER FOR PLASTIC REPAIR**  
Pince de serrage pour réparation des plastiques

082014



**PLASTIC WELDING STATION** - Station de soudage des plastiques - Kunststoff-Schweißset



320 W - 230 V, 1-50 Hz  
Temperature: 160 < 480°C  
▲ 3.4 kg  
Length of hose: 1 m  
Air flow: 24 l/min

Station seule  
- Station only  
064072



Ø 5 mm  
066694

Ø 8 mm  
066700

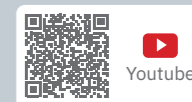

plastic rods - baguettes plastique 440 mm	PP / EPDM	▲ 4 mm	x 10	066304
		■ 6 mm	x 10	067622
		■ 8 mm	x 10	066298
	ABS	▲ 4 mm	x 10	071322
		■ 8 mm	x 10	071339

Station	PP/EPDM			Pressure wheels	Mini milling machine	Scraper
	4mm (x10)	6mm (x10)	8mm (x10)			
064072	✓					
070974			✓			



**WELDING KIT FOR PLASTICS** - Kit de soudage des plastiques - Kunststoff-Schweißset



1 600 W - 230V - 50/60 Hz  
max. 230 l/min  
▲ 1.3 kg / -L- Ø100 x 300mm,  
poignée Ø 56mm.

057678



Options  
TIP Ø5  
061262

TIP insert Ø5  
061279



x10  
052956

x1  
25 x 12.5 cm  
052949

**TOOL FOR REMOVING BUMPER** - Outil de déclipsage pare-chocs



076518



x15  
076525

**HAND SEAMER FOR PLASTIC REPAIR**  
Pince de serrage pour réparation des plastiques

082014



**MULTI-CLIP PLIER**  
Pince multi-clip

083813



DURABLE  
HIGH-CARBON  
STEEL

NEW

Cut + Grip

**BRAZING AUTOMOTIVE PLASTICS REPAIR KIT**  
- Coffret de réparation des plastiques automobiles - Kunststoff  
Reparatur Set

052932

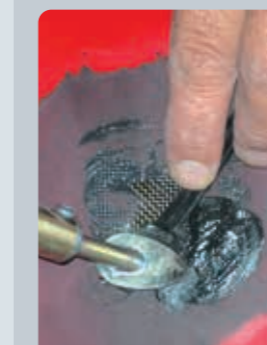

MADE IN BELGIUM

x10  
052956

25 x 12.5 cm  
x2  
052949

057258

052963



**WORKSTATION PREMIUM 5 DRAWERS - Servante premium 5 tiroirs**

± 64 kg  
Capacity 320 kg



**Complete carbody workstation**  
080119



included



**HAND CHISEL FOR CAR BODY**

- Burins  
- Meißel für Karosserie



**SET OF 4 NYLON CHISELS - Jeu de 4 burins en nylon - 4 Kunststoffmeißel**

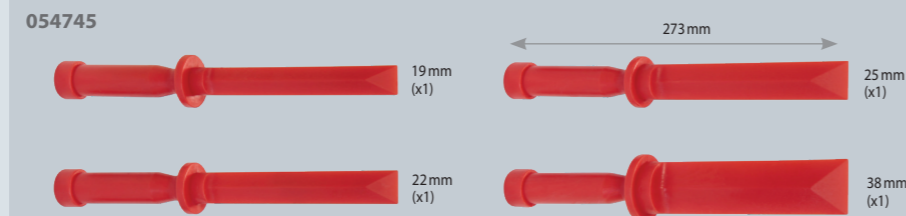

**SET OF 3 CHISELS - Lot de 3 burins de séparation éléments collés - 3 Meißel**



**SET OF 30 TOOLS FOR SCRAPING/SANDING AND PAINT REMOVAL - Outils de dégarnissage et raclage - Polster & Schaber Kit**



**SET OF 3 SCRAPING KNIVES - Couteaux racloirs**



**HAND TOOLS - Ausbeulwerkzeug**

• FULL PACK =  
061637



+ MEDIUM PACK  
051133



**PLANISHING HAMMER BLACKTEC®**

077270  
Rubberised gripping  
- Manche en caoutchouc



**ALU HAMMERS - Marteaux alu**

020986



**PLANISHING KIT FOR CAR BODY (SET OF 3 HAMMERS + 4 DOLLYS) - Kit marteaux et tas - Karosseriehammer & Handfaust Kit**



**SET OF 3 ALU HAMMERS + 4 ALU DOLLIES - Kit marteaux alu et tas alu - Karosseriehammer & Handfaust Kit**



**FORMING TOOLS - Outils de forme - Formgebungswerzeuge**



**BODYWORK BUMPING Mallet - Maillet souple caoutchouc - Karosserie-Schlaghammer**





### CONTOUR GAUGES - Jauges de profil - Konturenlehre



### LIP PLIER - Pince à lèvres - Falzzange gebogen

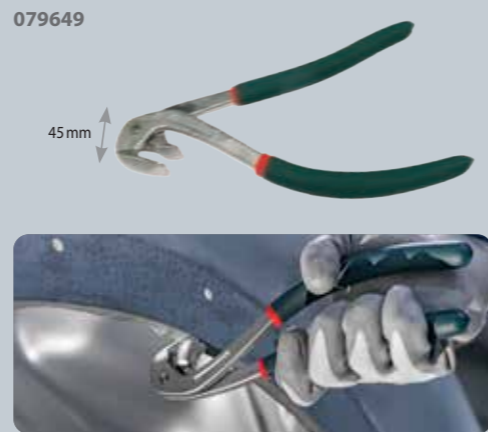

### SET OF PLIER + 10 STAPLES - Coffret pinces à agrafes



### POSITIONING CLAMP - Pincettes de maintien bord à bord - I-Stoß-Lehre

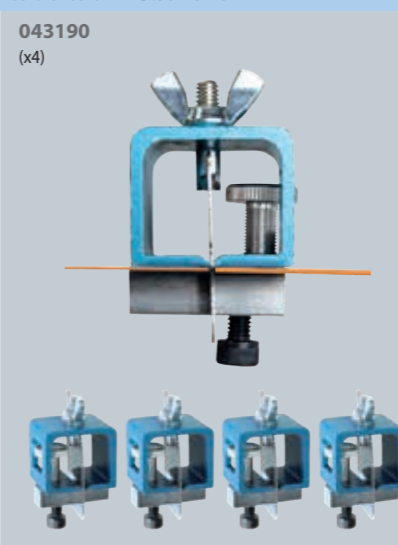

### TEMPORARY-FASTENERS MANUAL MOUNTING - Serre-tôles



### DOOR HINGE STRAIGHTENER - Redresseur de charnière de porte - Türgelekausrichter

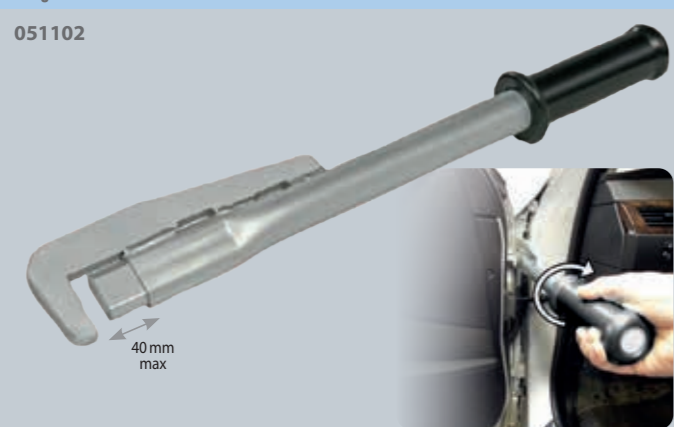

### DOOR ALIGNING TOOL - Outil d'alignement de portière - Türausrichtungswerkzeug



### GAPPING GAUGES - Jauges de positionnement - Spaltmaßlehre



### FENDER ROLLER TOOL SET - Outil de remise en forme passage de roue - Kotflügelrollen-Werkzeugsatz

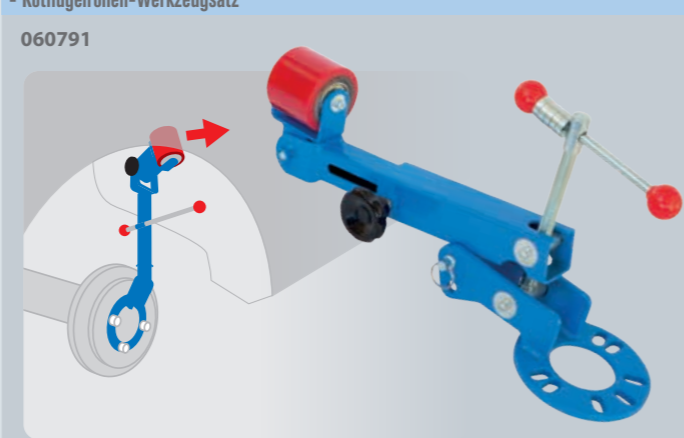

### MICRO-GRIP CLAMPS - Pincettes micro-grip

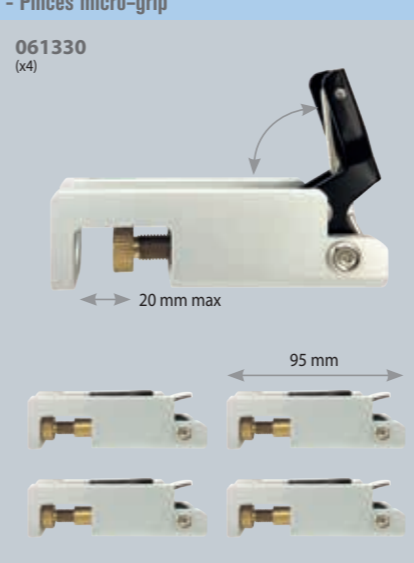

### MICRO-WELDING CLAMPS - Micro-bridges de soudage



### FLAT NOSE LOCK-GRIP PLIERS - Pincettes étou à bec plat

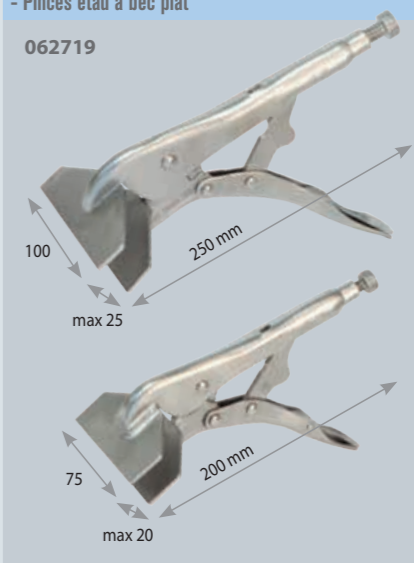

### AXIAL-GRIP PLIERS - Pincettes axiales

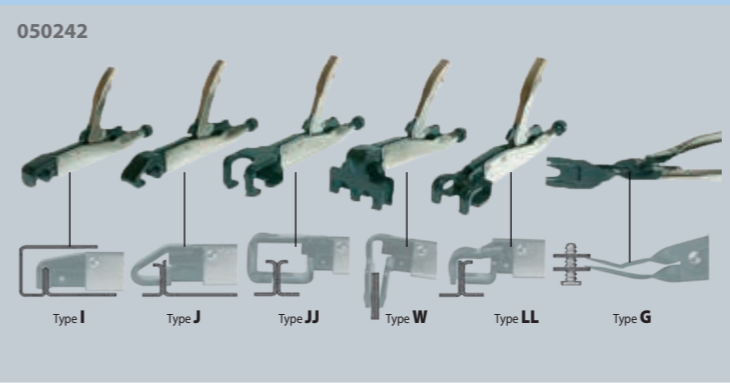

### LOCK-GRIP PLIERS - Pincettes étou mono serrage

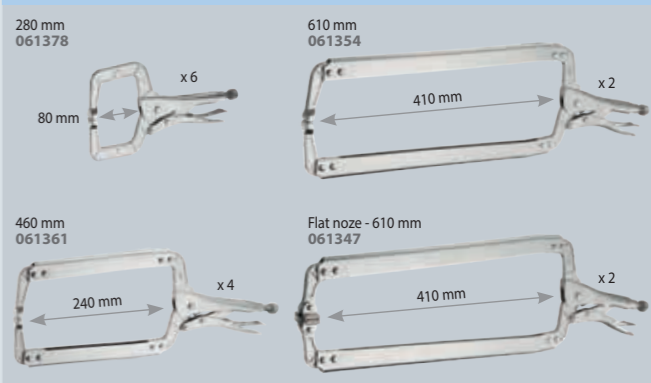

### MULTI-CLIP PLIER - Pince multi-clip



### BURR REMOVER - Outil d'ébavurage - Gratentferner

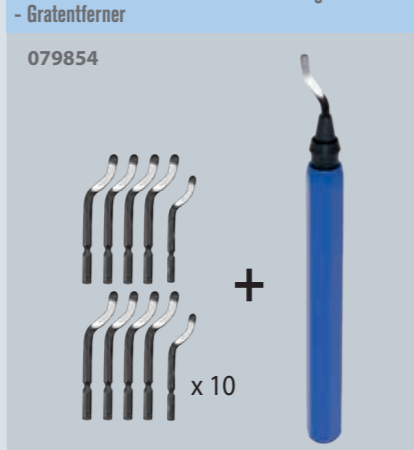

### BODY LINE TOOL - Traceur de ligne carrosserie - Markierhilfe für Kanten

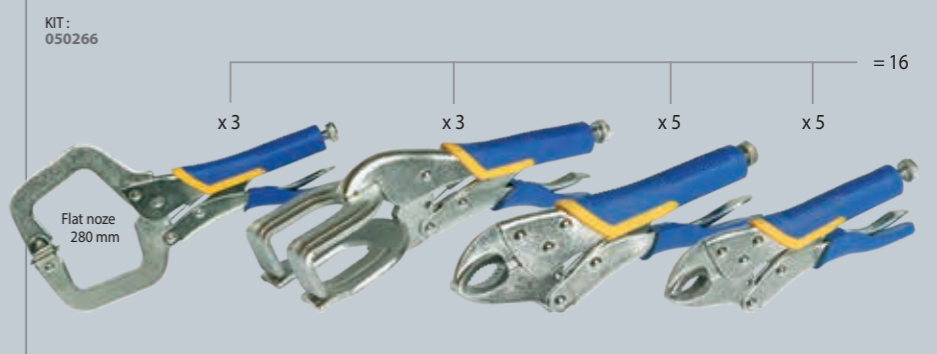
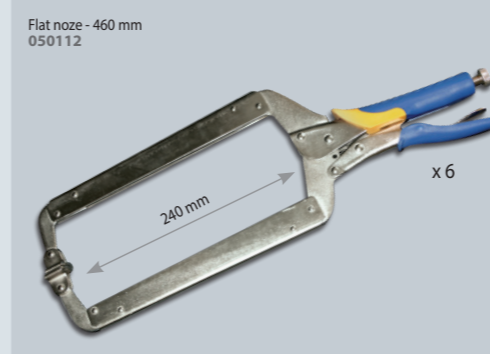



### MINI DISC SANDER - Mini-meuleuse - Druckluftschleifer

051829

Speed adjustment

Ø 75 mm

Speed rpm	Power W	dB	Air consumption l/min	Air pressure bar	cm	kg
18000	200	83	171	6.2	12	0.7

Included (x1) 052468

### LONG HANDLED ANGLE GRINDER - Meuleuse d'angle - Druckluft-Winkelschleifer

057753

Ø 100 mm

± 1.6 mm, x5 057883  
± 0.8 mm, x5 058217

Speed rpm	Power W	dB	Air consumption l/min	Air pressure bar	cm	kg
14000	84	113	6.2	37	1.7	

058248

x2 Ø  
Ø 50 & 75 mm

Speed rpm	Power W	dB	Air consumption l/min	Air pressure bar	cm	kg
15000	84	91	6.2	10	0.6	

### MINI ANGLE GRINDER - Mini-meuleuse à renvoi d'angle - Mini-Druckluftwinkelschleifer geräuschgedämpft

051867

Ø 50 mm

90°

Speed rpm	Power W	dB	Air consumption l/min	Air pressure bar	cm	kg
15000	200	86	85	6.2	18	0.75

(x1) 052772

MINI-FLEXIDISC LAMELLES ZIRCON Ø 50 mm

K 40 (x10) 058255  
K 60 (x10) 058262  
K 80 (x10) 058279

### AIR BELT SANDER - Ponceuse à bande à tête orientable - Druckluft Bandschleifer

060906

520 mm

20 mm

360°

Speed rpm	Power W	dB	Air consumption l/min	Air pressure bar	cm	kg
16000	171	6.3	34	1.2		

Grain 60 (x5) 060913  
Grain 80 (x5) 060920  
Grain 100 (x5) 060937  
Grain 36 céramique (x5) 062535

### SAW FOR STRAIGHT CUT AND FILE - Scie coupe tôle droite et lime - Druckluftsäge und Feile

051805

(x5) 052789

included 058750

Speed rpm	Power W	dB	Air consumption l/min	Air pressure bar	cm	kg
5000	—	85	255	6.2	10	0.8

### AIR BELT SANDER - Ponceuse à bande à tête orientable - Druckluft Bandschleifer

052819

360°

330 mm

10 mm

Speed rpm	Power W	dB	Air consumption l/min	Air pressure bar	cm	kg
16000	171	6.3	26	0.9		

Grain 80 (x10) 052833  
Grain 36 céramique (x20) 062528

### MINI ANGLE MILLING MACHINE - Mini-fraiseuse à renvoi d'angle - Mini-Winkelschleifer

051836

90°

Speed rpm	Power W	dB	Air consumption l/min	Air pressure bar	cm	kg
18000	500	81	85	6.2	18	0.7

### AUTOMATIC MANDREL DRILL - Perceuse mandrin automatique - Druckluftbohrmaschine m. Schnellspannfutter

051799

Ø 13

Speed rpm	Power W	dB	Air consumption l/min	Air pressure bar	cm	kg
800	300	92	170	6.2	18	0.9

### PNEUMATIC SURFACE REMOVER KIT - Coffret décapeuse pneumatique - Druckluftentroster-Box inkl. Zubehör

051775

Speed rpm	Power W	dB	Air consumption l/min	Air pressure bar	cm	kg
4000	500	86	102	6.2	280	1.2

Roue gomme 115 x 14 mm 051874  
Roue à découper 115 x 14 mm 051843  
Adaptateur pour brosse 051768

Brosse souple Brins droits 0.5 mm 103 x 23 mm 052598  
Brosse dure Brins incurvés 0.7 mm 103 x 23 mm 051812  
Brosse souple Brins incurvés 0.5 mm 103 x 23 mm 051850

### MINI MILLING MACHINE - Mini Fraiseuse - Mini-Schleifer

063228

Option  
Tungsten drill Ø 6 mm 054172

### LASER CORD METAL SHEET CUTTER (NIBBLER) - Dépointeuse pour cordon laser ACIER - Trennwerkzeug für Lasernähte

054165

Ø 6 mm

STEEL Included 054172

6 mm 20 mm 052437  
8 mm 20 mm 067264

### PUNCHING TOOL FOR OVAL HOLES - Outil de poinçonnage oblongs - Langlochkarosserieblechzange

2.2 kg

6 mm 20 mm 052437  
8 mm 20 mm 067264

### PNEUMATIC FLANGE / PUNCHING TOOL - Pince à soyer et à trous, pneumatique - Pneumatische Loch- und Absatzzange

079892 Ø 8 mm  
0.8 > 1,2 mm

052543 Ø 5 mm  
0.8 > 1,2 mm

2 in 1

0.8 > 1,2 mm

### BODY ZIPPER - Sertisseuse pneumatique - Pneumatic Crimper - Druckluftkantenformer

056930

MADE IN HIGH QUALITY POLAND

1) MINI  
2) initial W  
3) final M x < 2.4mm  
4) final D x > 2.4mm

Air pressure bar	cm	kg
5	28	2.1

### SPOT REMOVER - Dépointeuse - Druckluft-Schweißpunktbohrer

SPOT DRILL 050464

360°

Ø 8

Included: Tungsten Carbide Ø 8 for BORON/UHSS (x1)

HIGH QUALITY

Speed rpm	Power W	dB	Air consumption l/min	Air pressure bar	cm	kg
800	400	85	140	6.5	35	2.3

Spot remover drill - Forets de dépointage - Schweißpunktfräse Tungsten Carbide for BORON/UHSS

3-edge	Ø 8 mm	Ø 9 mm	Ø 10 mm
	053069	069763	053076
4-edge Efficiency ++ Durability ++	Ø 8 mm	Ø 9 mm	
	059849	069770	

PACK SPOT DRILL + 140 mm 061460

140 mm 061453

3-edge Ø 8 mm 053069



## HAND LAMPS - Lampes baladeuses - Handleuchte

### PORTABLE HAND LAMP 400 L 400 lumens

COB LED  
Li-ion  
Charging time: 8h  
**operating time**  
High position: 2.5 h  
Low position: 5 h  
Top light (1 W): 6 h

↓ 7 x 4 x 23 cm / 0.3 kg  
⊗ 14 x 7 x 24 cm / 0.5 kg

059153



### PRO PORTABLE LAMP 600 L 250-600 lumens

COB LED, 80 CRI  
3.7 V - 2200 mAh Li-ion  
micro USB charging (3.5 h)  
**operating time:**  
High position: 1.5 h,  
Mid position: 4.5 h,  
Top light (100 lumens): 10 h

IP 54  
↓ 3 x 6 x 19 cm / 0.3 kg  
⊗ 9 x 13 x 24 cm / 0.6 kg

060883



## INSPECTION LAMPS - Lampes d'inspection - Inspektionlampen

### INSPECTION HEADTORCH 280 L 100-280 lumens

3 W COB LED, 80 CRI+, 6500 K  
3.7 V - 1500 mAh Li-po  
micro USB charging  
mains charger not incl.  
**operating time**  
High position: 2 h  
Low position: 6 h  
IP 65

↓ 8 x 5 x 4 cm / 0.1 kg  
⊗ 5 x 11 x 18 cm / 0.2 kg

060845



### 360° PORTABLE WORKSPACE LAMP 1000 L 60-1000 lumens

>80 CRI SMD LED  
6500 K  
3.7 V - 5200 mAh Li-ion  
USB charging (4.5h)  
USB power supply  
**operating time** 2 > 27 h

IP 54  
↓ 26 x 7 x 7 cm / 0.5 kg  
⊗ 8 x 8 x 35 cm / 0.7 kg

059764



### MINI INSPECTION LAMP 200 L 120-200 lumens

COB LED, 80 CRI, 6500 K  
3.7 V - 700 mAh Li-ion  
micro USB charging (2.5 h)  
mains charger not included  
**operating time**  
High position: 1.5 h  
Low position: 4 h  
Top light: 3.5 h  
IP 20

↓ 18 x 3 x 3 cm / 0.1 kg  
⊗ 18 x 5 x 3 cm / 0.2 kg

060852



### MINI INSPECTION LAMP 350 L 0-350 lumens

COB LED  
3.7 V - 1100 mAh Li-ion  
USB charging (3 h)

**operating time**  
3 > 6.5 h

IP 20

075894

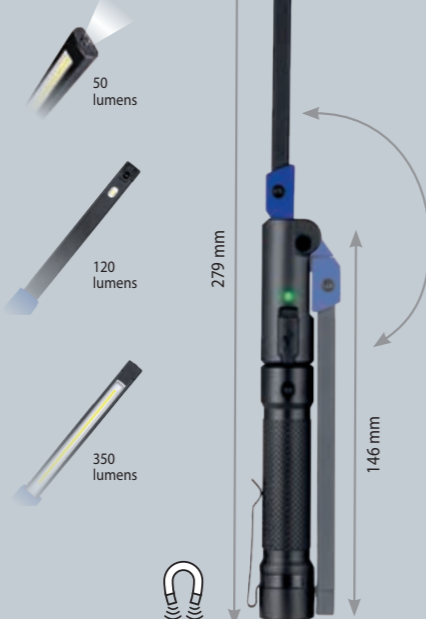

### PRO INSPECTION LAMP 800 L 120-800 lumens

COB LED  
3.7 V - 2600 mAh Li-ion  
USB charging (4 h)

**operating time**  
2.5 > 9 h

IP 54

075900

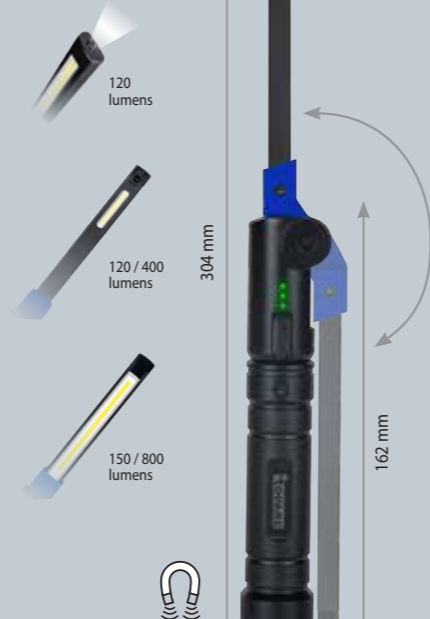

## LED WORKLIGHTS WITH TRIPOD - Projecteurs led sur trépied - LED-Arbeitsleuchte mit Standfuß

### TRIPOD LAMP 1800 L 1800 lumens

3x 55 COB LED  
total 165 LED

1.8 m power cord

059146

⊗ 95 x 15 x 14 cm / 3.2 kg

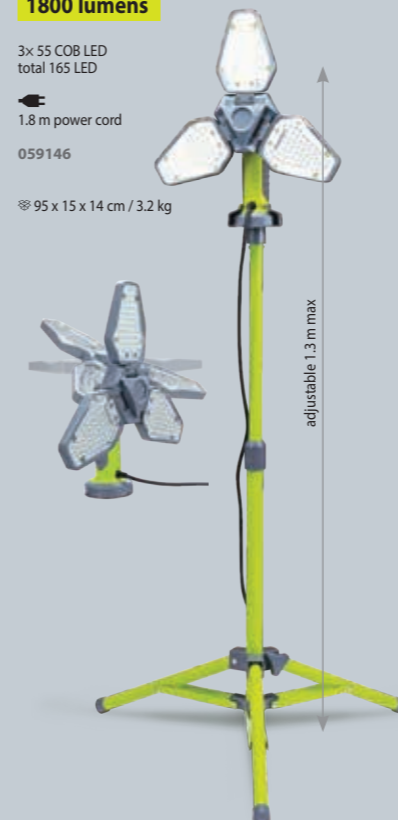

### TRIPOD LAMP 3000 L 3000 lumens

35 W COB LED

2 m power cord

IP 44

059979

↓ 100 x 20 x 9 cm / 3.6 kg  
⊗ 103 x 22 x 10 cm / 4.1 kg



### TRIPOD LAMP 4000 L 4000 lumens

3x 20 COB LED,  
total 60 LED

3 m power cord

059986

↓ 21 x 15 x 114 cm / 5.7 kg  
⊗ 22 x 116 x 117 cm / 6.4 kg

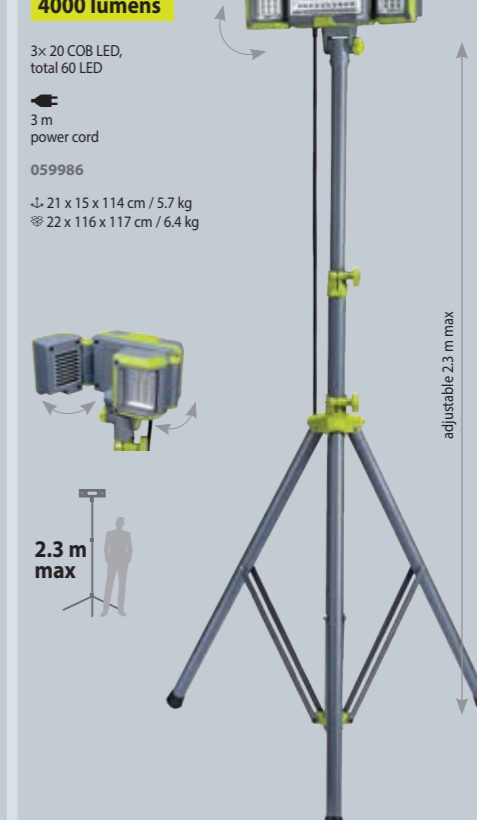

## UNDER BONNET LAMPS - Lampes sous capot - Leuchte für Motorhaube

### UNDER BONNET HAND LAMP 600 L 500-1000 lumens

120 COB LED

3.7 V - 4000 mAh Li-ion  
charging time: 10/12 h

**operating time**  
High position: 4 h  
Low position: 8 h

↓ 22 x 11 x 68 cm / 1.8 kg  
⊗ 24 x 12 x 70 cm / 2.3 kg

059962

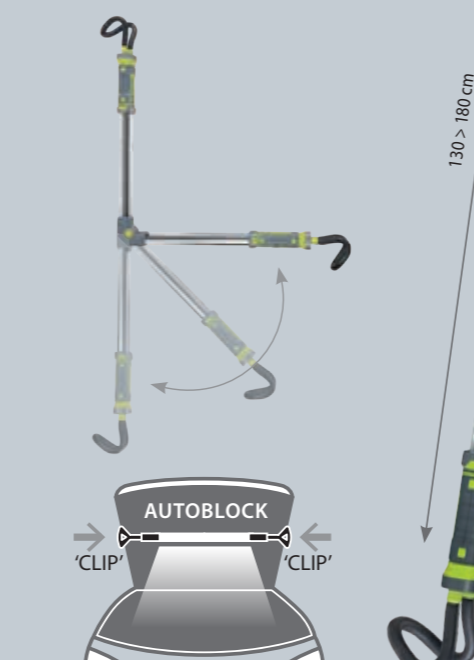

### UNDER BONNET LAMP AND TRIPOD 800 L 250-800 lumens

120 COB LED

3.7 V - 4000 mAh Li-ion  
charging time: 10/12 h

**operating time**  
High position: 3 h  
Low position: 6 h

↓ 60 x 10 x 7 cm / 1.2 kg  
⊗ 61 x 15 x 12 cm / 2 kg

058002

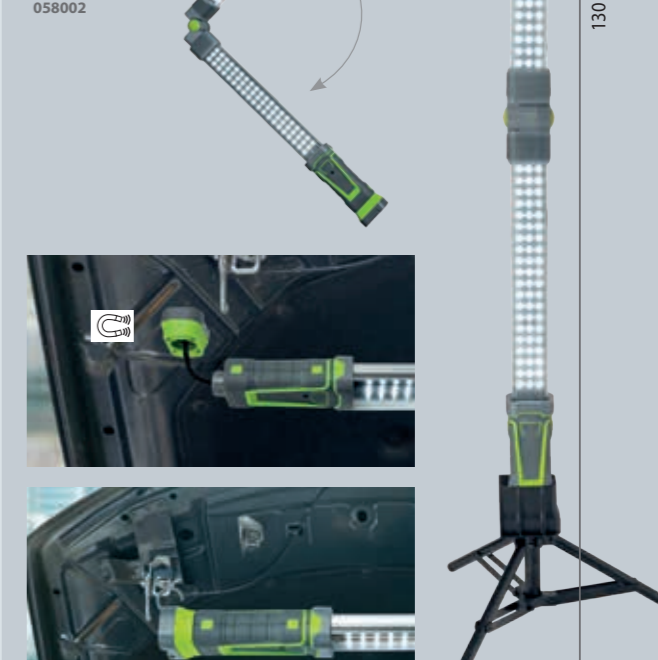



## DETAILING & COLOUR MATCH - Contrôle des couleurs - Fabnpassung & Aufbereitung

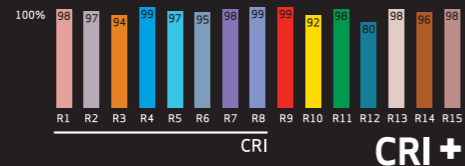

### 4500 K

400 lumens

#### SUNCOLOR 1

COB LED, CRI > 95, 1100 lux  
3.7 V - 2600 mAh Li-ion  
USB charging  
operating time : 3 h  
↓ 6 x 3 x 19 cm / 0.6 kg  
⊗ 22 x 14 x 10 cm / 0.7 kg  
IP 65

058477



### 3 COLORS

2700 - 4500 - 6500 K

350-420-450 lumens

#### SUNCOLOR 3

COB LED, 96 CRI+  
3.7 V - 2600 mAh Li-ion  
micro USB charging (4 h)  
operating time : 2.5/4 h  
IP 65  
↓ 4 x 6 x 9 cm / 0.3 kg  
⊗ 9 x 13 x 24 cm / 0.6 kg

060838



### 5 COLORS

2700 - 3500 - 4500 - 5500 - 6500 K

500-1000-2000 lumens

#### SUNCOLOR 5

COB LED, 96 CRI+  
11.1 V - 4400 mAh Li-ion  
charger 110/240 V, 5 m cable, 15 V, 1.5 A  
operating time : 3.5 h  
operating time  
High position : 2 h, Mid : 4 h, Low : 8 h  
IP 65  
↓ 7 x 23 x 20 cm / 1.2 kg  
⊗ 9 x 25 x 24 cm / 1.9 kg

060876

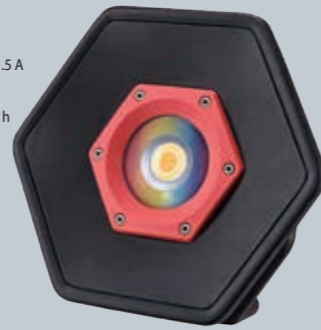

### 5 COLORS

2500-3500-4500-5500-6500 K

50-200-500 lumens

#### SUNMATCH 4

COB LED, 96 CRI+, 700-1400 lux  
3.7 V - 2600 mAh Li-ion, USB charging  
operating time :  
High position : 2 h, Low position : 4 h  
IP 65  
↓ 4 x 6 x 19 cm / 0.3 kg  
⊗ 8 x 9 x 21 cm / 0.5 kg

061651



### UV CURING - SÉCHAGE UV

UV LED λ 395-400 nm

Irradiance 6-15 mW/cm²

#### NOVA-UV 5

3.7 V - 5400 mAh Li-ion  
USB charger, 1 m cable, 5 V, 2 A  
charging time : 3.5 h  
curing area : Ø 20 cm  
operating time 1.5 h  
IP 67  
↓ 7 x 17 x 16 cm / 0.9 kg  
⊗ 7 x 17 x 18 cm / 1 kg

061620



Curing area  
Ø 20 cm

## FILM COATING THICKNESS GAUGE

- Détecteur épaisseur de peinture

059856

Measurement range : 0 - 1.80 mm  
Resolution : 0.01 mm / 1 mm  
Measurement error : +/- 0.03 mm  
Power Supply : 2x 1.5V AAA batteries (included)  
Overall dimensions : 62 x 30.5 x 105 mm



## 4 MAGNETIC PANEL EDGE PROTECTIONS

- 4 protections magnétiques de ponçage pour bord de panneau

082793

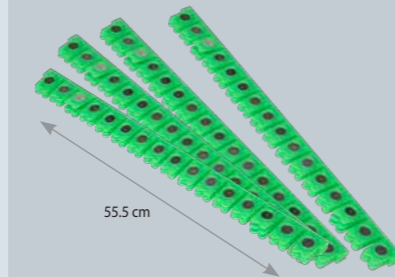

55.5 cm

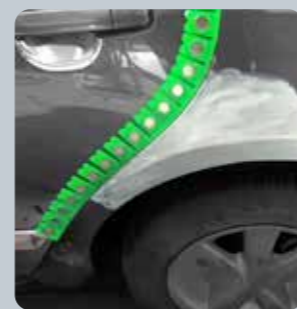

## ELECTRIC SANDER & POLISHER

- Ponçeuse /polisseuse électrique - Elektro-Polier-Schleifer

057999

Orbital 5.0 mm  
↓ 27 x 15 x 10 cm / 1.5 kg  
⊗ 37 x 18 x 12 cm / 1.9 kg

Speed : 4000, 7000, 9000 10000 rpm  
AC-in 220V - 230V / 50 - 60Hz

Light weight  
& Compact

(( No vibration ))



Speed control

Ø 35

Ø 152 mm



058293

Power supply : 230V / 50Hz  
Power : 1400W (max 2000W)  
Max. vacuum : 170 mbar  
Air flow : 2700 l/min  
Drum capacity : 30 L  
Drum material : stainless steel

↓ 33 x 33 x 63 cm / 4.9 kg  
⊗ 38 x 38 x 67 cm / 7.8 kg

Manual  
or  
automatic



4m  
Input Ø 32 mm  
Mains cable length 4.5m

## GYS DUST EXTRACTOR - Pneumatic dust vacuum cleaner for sander

### INNOVATIVE SUCTION SYSTEM

Depression 1150 mm H<sub>2</sub>O

Air flow 600 l/min

Air consumption 340 l/min



BREVET GYS  
GYS PATENT



Adjustable sander pressure - Pression ponçeuse ajustable  
**5 bar max**

↓ 49 x 48 x 88 cm / 21.5 kg  
⊗ 81 x 40 x 49 cm / 24.1 kg



ATEX norm  
Group II - Category 3

EN 60335-2-69 : 2012

- ✓ ROBUST
- ✓ QUICK & SAFE
- ✓ LOW AIR CONSUMPTION  
(5 bar)
- ✓ NO ELECTRIC MOTOR
- ✓ ENERGY SAVING

Sanding discs box\*  
- Rangement pour disques de ponçage\*  
\* discs box not included - disques de ponçage non inclus

Grande maniabilité et stabilité  
- High maneuverability and stability

### EASY ACCESS

Maintenance free  
- Aucune maintenance



### Consumables

Sac à poussières -  
Filter bag  
Capacity 5 kg  
  
Included x1  
  
x 5  
058880



Pneumatic Sander  
- Ponçeuse pneumatique  
**MIRKA PROS 650CV**  
  
Ø 150 mm  
**071346**

### 2 MODELS

#### GYS DUST EXTRACTOR

MANUAL

Manual start  
- Démarrage manuel

071353



#### GYS DUST SELF EXTRACTOR

AUTOMATIC

BREVET GYS  
GYS PATENT  
Automatic start  
- Démarrage automatique

077058





**ERGONOMIC PRO SUPPORT FOR PAINTING ELEMENTS** - Support Pro ergonomique pour peinture d'éléments  
- Ergonomische Pro-Unterstützung für Malelemente

082656

**NEW**  
05/2024

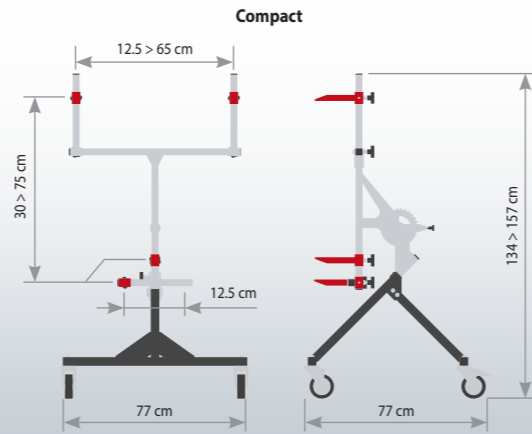
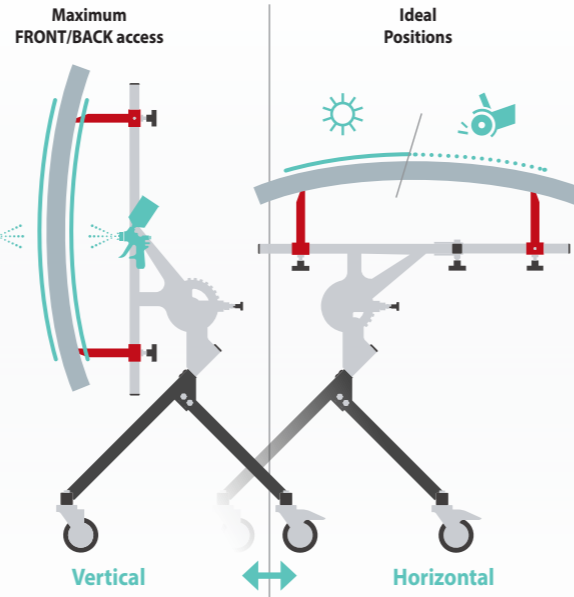
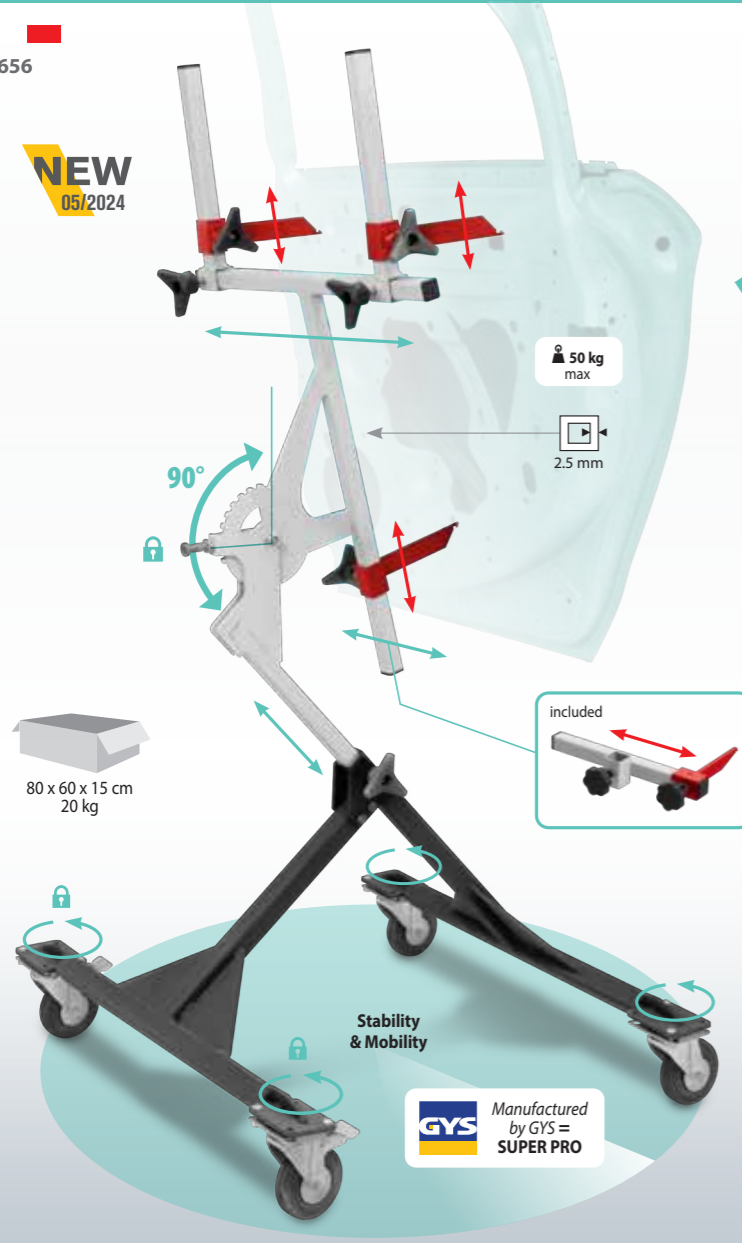

**ROTARY ELEMENT SUPPORT** - Support élément rotatif  
- Lackierständer für Stoßstange, einstellbar

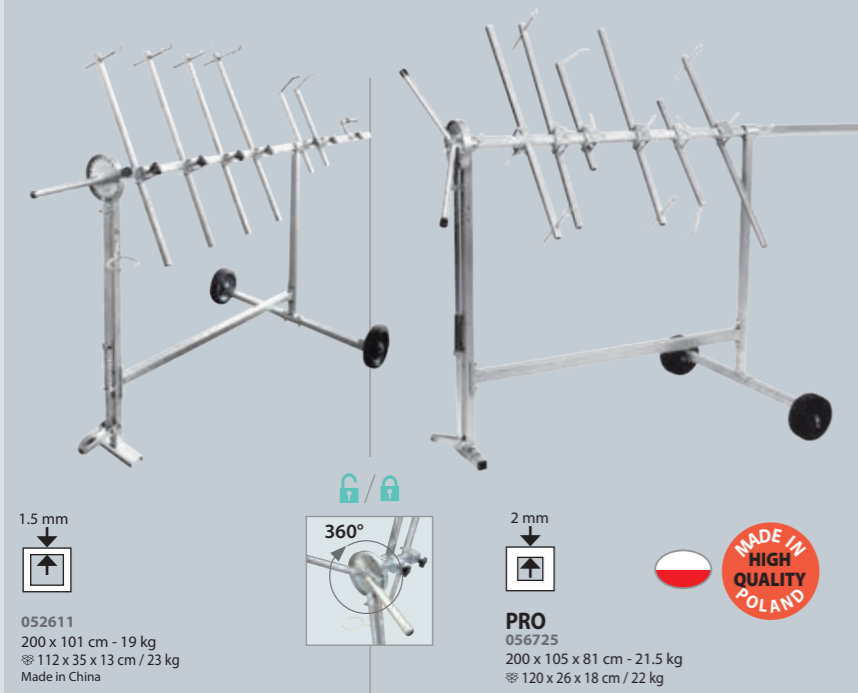

052611  
200 x 101 cm - 19 kg  
⊗ 112 x 35 x 13 cm / 23 kg  
Made in China

**PRO**  
056725  
200 x 105 x 81 cm - 21.5 kg  
⊗ 120 x 26 x 18 cm / 22 kg

**WHEELS PAINTING SUPPORT** - Support de peinture  
pour 2 jantes - Lackträger für 2 Felgen

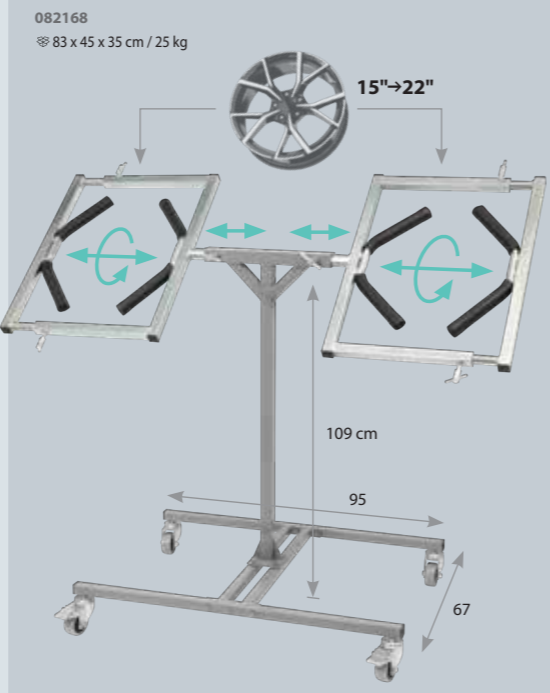

082168  
⊗ 83 x 45 x 35 cm / 25 kg

**FRAMES SUPPORT** - Tréteaux - Klappbücke



**TELESCOPIC FRAMES SUPPORT** - Tréteaux télescopiques - Teleskopbücke

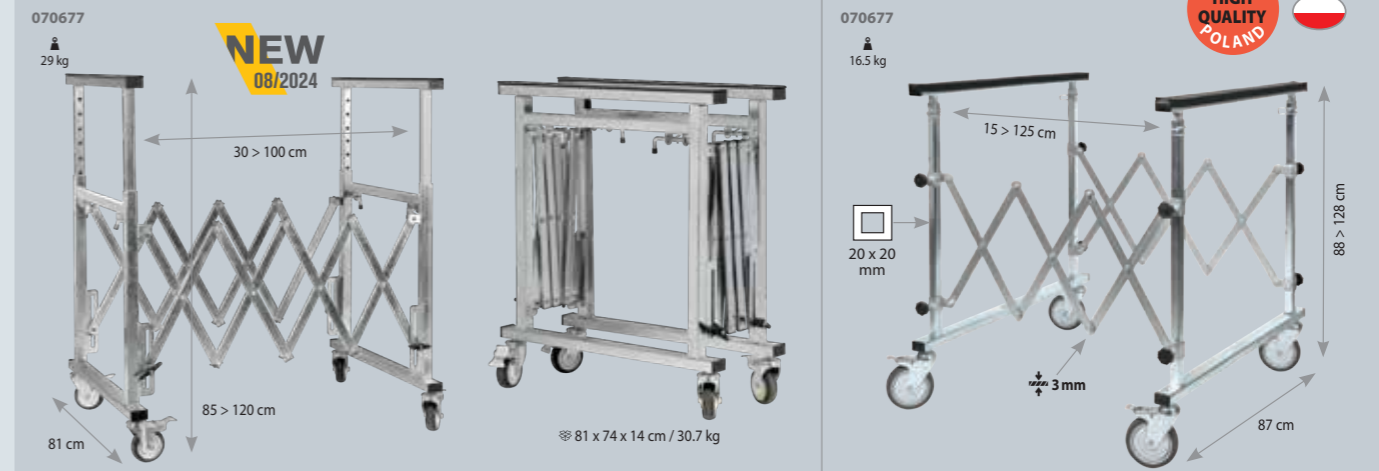

**MASKING MACHINE**  
- Chariot de marouflage - Abdeckpapier-Ständer



083905  
132 x 95 x 91 cm / 35 kg  
⊗ 109 x 92 x 27.5 cm / 37 kg

x 4 (not included)  
Paper roll - Rouleaux de papier - Papierständer  
30, 60, 100, 100 cm

**PREMIUM MASKING MACHINE**  
- Chariot de luxe marouflage - Abdeckpapier-Ständer



057333  
150 x 133 x 62 cm / 31 kg  
⊗ 152 x 30 x 18 cm / 31.5 kg

x 5 (not included)  
Paper roll - Rouleaux de papier - Papierständer  
30 > 120 cm

**ROTARY ELEMENT SUPPORT**  
- Support pare-chocs - Lackierständer für Stoßstange, einstellbar



052376  
⊥ 50 x 70 x 10 cm / 7.3 kg  
⊗ 60 x 77 x 12 cm / 8.3 kg

Adapted to wing mirror covers - Adapté aux coques de rétroviseurs - Geeignet für Außenspiegel

**MASKING MACHINE**  
- Chariot de marouflage - Abdeckpapier-Ständer



056954  
150 x 62 x 110 cm / 11 kg  
⊗ 154 x 30 x 19 cm / 12 kg

x 3 (not included)  
Paper roll - Rouleaux de papier - Papierständer  
30, 60, 90 cm



**STORAGE TROLLEY - Chariot de stockage**  
- Lagerrollwagen

059825

106 x 104 x 215 cm - 32.5 kg  
112 x 31.5 x 21.5 cm  
+ 12 x 9.5 x 194.5 cm

**STORAGE TROLLEY - Chariot de stockage**  
- Lagerrollwagen

059832

↓ 50 x 150 cm / 11.3 kg  
⊗ 155 x 18 x 12 cm / 13.8 kg

**STORAGE TROLLEY - Chariot de stockage**  
- Lagerrollwagen

040243

71 x 90 x 197 cm / 41 kg  
⊗ 2 : 90 x 6 x 147 cm + 97 x 74 x 24 cm

**ROUND STOOL WITH TOOL STORAGE**  
- Tabouret - Werkstatt-Rollhocker

057555  
38 x 38 x 44 cm - 5.2 kg  
⊗ 41 x 19 x 41 cm / 5.6 kg

max : 50 cm  
min : 38 cm

6 cm

**WORKSTATION PREMIUM 5 DRAWERS**  
- Servante premium 5 tiroirs

076143  
⊗ 64 kg  
Capacity 320 kg

4 Keys - 4 Clés

32 x 45 x 6 cm  
65 x 48 x 12 cm  
75 x 47 x 9 cm  
65 x 45 x 12 cm  
32 x 45 x 12 cm

105 cm

56 cm 87 cm

**UNIVERSAL SUPPORT - Chariot pour éléments de carrosserie**  
- Universelle Ständer

083868  
56 kg  
⊗ 102 x 72 x 27 cm / 59 kg

**NEW**

210 cm

+ 60 cm

85 cm 100 cm

**FOLDING STEP STOOL - Marche pied (Aluminium)**  
- Arbeitspodest klappbar

080041  
7.3 kg  
⊗ 100 x 39.5 x 19 cm / 8.1 kg

**ALU**

150 kg max

850 mm

490 mm

1180 mm

300 mm

**MOBILE RACK FOR CAR BODY REPAIR - Rack mobile pour éléments de carrosserie**

082472  
⊗ 128 x 30 x 15 cm / 20 kg  
↓ 18.8 kg

**NEW**

150 kg max

635 mm

1200 mm 700 mm

**FOLDING STEP STOOL - Marche pied (Aluminium)**  
- Arbeitspodest klappbar

057562  
7.9 kg  
⊗ 102 x 39 x 19 cm / 8.5 kg

**ALU**

150 kg max

960 mm

475 mm

385 mm

**ROUND STOOL WITH STORAGE**  
- Tabouret d'atelier 3 tiroirs

079878  
47 x 35 x 43 cm  
⊗ 38.5 x 37 x 38.5 cm - 13 kg

**MECHANICS CREEPER WITH TILTING HEADREST**  
- Chariot de visite - Werkstatt-Rollliege

057548  
102 x 43 x 11 cm / 5.3 kg  
⊗ 104 x 45 x 13 cm / 6 kg

**MOBILE WORKSTATION**  
- Table de travail mobile

079465  
⊗ 120 x 82 x 18 cm / 40.3 kg

**100 kg max**

1170 mm

390 mm

1030 mm

750 mm

Ø 290 mm

**FLAP LOCK - Tiges de blocage**

056732

30 > 115 cm

**FOLDING STEP STOOL - Marche pied (Aluminium)**  
- Arbeitspodest klappbar

058552  
↓ 113 x 41 x 16 cm / 16 kg  
⊗ 117 x 42 x 17 cm / 17 kg

**ALU**

150 kg max

1090 > 1750 mm

520 > 900 mm

300 mm

**2 IN 1 MECHANICS CREEPER**  
- Chariot de visite 2 en 1 - Werkstatt-Rollliege

079861  
102 x 40 x 14 cm  
⊗ 40 x 13 x 63 cm - 7.6 kg

**WORKSTATION 3 SHELVES**  
- Servante 3 plateaux

068056  
⊗ 77 x 53 x 21 cm / 18.2 kg

**65 kg max**

65 kg max

65 kg max

835 mm

300 mm 800 mm



**1T MOBILE LIFTING TABLE WITH HYDROPNEUMATIC PUMP** - Table élévatrice mobile 1 tonne avec pompe hydropneumatique  
- Mobilier 1-Tonnen-Hubtisch mit hydropneumatischer Pumpe

083912  
Weight : 385 kg



**NEW**

max : 180 cm  
min : 105 cm  
130 cm  
Ø 20 cm

Reserved holes pattern - Quadrillage de trous taraudés  
100 x 100 mm M10

max : 148 cm  
min : 130 cm  
80 cm  
1 t max

Hydropneumatic pump - Pompe hydropneumatique  
110 s ↑  
30 s ↓  
6-8 bar

**EQUIPMENT FOR OPERATIONS ON ELECTRIC AND HYBRID VEHICLES** - Équipements pour opérations sur véhicules électriques & hybrides -  
Ausrüstung für den Betrieb von Elektro- und Hybridfahrzeugen

**FACE SHIELD WITH HEADBAND** - ÉCRAN FACIAL AVEC SERRE-TÊTE  
068018



**INSULATING GLOVES (T10)** - GANTS ISOLANTS (T10)  
068025



**25 pieces insulated tools 1000V** - Coffret de 25 outils isolés 1000V  
066489

7/8/10/12/14/15/17/19/22 mm sockets - Douilles 7/8/10/12/14/15/17/19/22 mm	x 9
175 mm universal pliers in chrome vanadium - Pince universelle de 175 mm en chrome vanadium	x 1
Cutting pliers 150 mm in chrome vanadium - Pince coupante 150 mm en chrome vanadium	x 1
3/8" ratchet - Cluqlet en 3/8"	x 1
Extension 100 mm - Rallonge 100 mm	x 1
T-handle - Poignée en T	x 1
Open ended wrenches 7/8/10/12/14/17 mm - Clés plates à fourches 7/8/10/12/14/17 mm	x 6
Cable knife - Couteau pour câble	x 1
Philips PhH1x100/PhH2x100 mm screwdriver - Tournevis Phillips PhH1x100/PhH2x100 mm	x 2
Flat screwdriver 5.5x125 / 4x100 mm - Tournevis plats 5.5x125/4x100 mm	x 2



**Kit for marking the area of intervention** - Kit pour le balisage de la zone d'intervention  
- Kennzeichnungsset für Hochvolt-Bereiche  
064409

Red and white warning pole - Balise de signalisation rouge et blanche	x 4
Red and white bounding line - Chaîne de délimitation rouge et blanche	x 1
Sign board "Danger, working area EHV" - Pancarte de signalisation "Danger, zone de travail VEH"	x 2



**1.2T LIFTING TABLE FOR ELECTRIC VEHICLE BATTERIES** - Table de levage 1.2T pour batteries de véhicule électrique  
- 1,2T Hubtisch für Elektrofahrzeugbatterien

083929  
Weight : 760 kg



**NEW**

max : 207 cm  
min : 174 cm  
80 cm  
4 cm  
2 cm  
90 cm  
max : 181 cm  
min : 80 cm  
Ø 20 cm  
235 cm

Reserved holes pattern - Quadrillage de trous taraudés  
100 x 100 mm M10

1.2t max

230 V ~1 phase  
50 Hz

FAST : 45 s ↑  
PRECISE : 170 s ↑  
40 s ↓



**TROUSERS** - Pantalon - Hose



98% cotton, 2% antistatic

EN ISO 11611 Class 2-A1 & A2  
EN ISO 1149-5  
EN ISO 11612 A1+A2-B1-C1-E3-F1  
IEC 61482-2 Class 1-4kA

S (40/42) 046368  
M (44/46) 046375  
L (48/50) 046382  
XL (52/54) 046399  
XXL (56/58) 046412

**JACKET** - Veste - Jacke



98% cotton, 2% antistatic

EN ISO 11612 A1+A2-B1-C1-E3-F1  
EN ISO 1149-5  
EN ISO 11611 Class 2-A1 & A2  
EN 14404 +A1 Type 2  
EN 1149-5

S (40/42) 046313  
M (44/46) 046320  
L (48/50) 046337  
XL (52/54) 046344  
XXL (56/58) 046351









INVEST IN THE FUTURE



French manufacturer  
since 1964

2  
0  
2  
4  
B

# Collision Repair

Solutions Réparation Carrosserie  
Karosseriereparatur  
Attrezzature Riparazione Carrozzerie  
Reparación de Carrocería



LinkedIn  
 Youtube  
 WeChat  
 Facebook  
 Instagram

[www.gys.fr](http://www.gys.fr)



## GYS FRANCE

### HEADQUARTERS

1 rue de la Croix des Landes  
CS 54159  
53941 Saint-Berthevin - Cedex  
Laval - France  
Tel +33 2 43 01 23 60  
E-mail [service.client@gys.fr](mailto:service.client@gys.fr)



ZI, 134 bd des Loges  
53941 Saint-Berthevin  
Laval - France

### LOGISTIC CENTER

2 Rue Jean Dausset  
53810 Changé - France  
Tel +33 2 43 01 54 33



## GYS GERMANY

Professor-Wieler  
Straße 11  
52070 Aachen  
Deutschland

Tel +49 241/189-23-710  
Fax +49 241/189-23-719  
E-mail [aachen@gys.fr](mailto:aachen@gys.fr)



## GYS UK

Unit 3 - Great Central Way  
Rugby - Warwickshire  
CV21 3XH  
United Kingdom

Tel +44 1926 338 609  
Fax +44 1926 429 764  
E-mail [uk@gys.fr](mailto:uk@gys.fr)



## GYS ITALIA

Via Porta Est, 7  
30020 Marcon - VE  
Italia

Tel +39 041 53 21 565  
E-mail [italia@gys.fr](mailto:italia@gys.fr)



## GYS IBÉRICA

Avenida Pirineos 31  
Nave 9  
San Sebastian de los Reyes  
28703 Madrid  
España

Tel +34 917 409 790  
E-mail [iberica@gys.fr](mailto:iberica@gys.fr)



## GYS CHINA

Lot N°15  
6666 bd Songze  
201706 Qingpu  
Shanghai  
China

Tel +86 6221 4461  
Fax +86 5226 0067  
[www.gys-china.com.cn](http://www.gys-china.com.cn)  
E-mail  
[contact@gys-china.com.cn](mailto:contact@gys-china.com.cn)

## MARKETING

Display stand  
- Podium de  
présentation  
- Podest

**PODIUM 1**  
A : 45 cm  
B : 50 cm  
C : 50 cm  
063204

**PODIUM 2**  
A : 80 cm  
B : 50 cm  
C : 50 cm  
063211

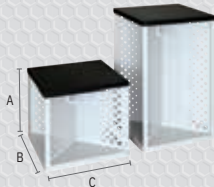

Flag -  
Oriflamme  
3 x 0,50 m  
098015



Barnum  
3 x 3 m  
098022



Open barnum  
2 x 2 m  
098039

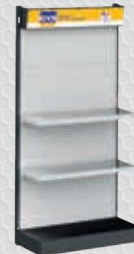

Retail display  
space with 2  
shelves  
- Linéaire de vente  
avec 2 étagères  
- Lochwandregal  
mit 2 Böden  
(machines not  
included)  
060784



Distributed by